

# Operation Manual

## **MODEL 647A, 647C & 649A** *25 & 55 Gallon Automatic Preservative Applicators*



*Equipment and Products  
for Quality Hay.™*

---

P.O. Box 63 • 2821 Harvey Street • Hudson, WI 54016  
800-635-7468 • [www.harvesttec.com](http://www.harvesttec.com)

(intentionally blank)

# Harvest Tec 647, 647C & 649 Operation Table of Contents

	<u>Page</u>
<b>Introduction</b>	<b>5</b>
<b>System Requirements</b>	<b>5</b>
<b>Model Reference Chart</b>	<b>5</b>
<b>Safety</b>	<b>6</b>
<b>Safety Decals</b>	<b>6</b>
<b>Safety Decal Locations</b>	<b>7</b>
<b>Preparing the Applicator for Operation</b>	<b>8-9</b>
Filling the Tank	8
Connecting the Power Harness	9
Operation of the Main Ball Valve	9
<b>Bluetooth Operation</b>	<b>10-14</b>
Turn On / Off iPad	10
Downloading Hay App	10
Shutting Down Hay App	11
Bluetooth Receiver	11
Device Selection	12
Manual Selection & Recommended Preservative	13
Tab Descriptions	14
<b>Screen Menus</b>	<b>15-18</b>
Automatic Mode & Manual Mode	15
Setup Mode	16
Job Records	17-18
<b>First time and Annual Startup Instructions</b>	<b>19</b>
Checking and Priming the Pumps	19
<b>Setting up the System for Initial Use</b>	<b>20-21</b>
Application Rate	20
Baling Rate	21
Fixed Chamber	21
<b>Operating Instructions</b>	<b>22-27</b>
Automatic Mode	22
Manual Mode	23
Job Records	24
Download Job Records	25
Export Job Records (emailing records)	26
Export Job Records (saving to iPad)	27
<b>Wiring Diagram 647, 649</b>	<b>28</b>
<b>Wiring Diagram 647C</b>	<b>29</b>
<b>Pin Outs</b>	<b>30-32</b>
<b>Common Questions</b>	<b>33</b>
<b>Troubleshooting</b>	<b>34-45</b>
<b>Status Alerts</b>	<b>35</b>
<b>iPad Troubleshooting</b>	<b>36</b>
<b>Maintenance</b>	<b>37-40</b>
Maintenance Schedule, Diagnostics, Filter Bowl Cleaning	37
Tips & Tip Screen Cleaning – Spray Shield	38
Tips & Tip Screen Cleaning – Nozzle Tubes	39
Miscellaneous Maintenance, Winter Storage	39
Tank Lid Cleaning, Dielectric Grease Connections, Rebuild Pumps	40
Battery Connections, Check valves	40
<b>Parts breakdowns</b>	<b>41-57</b>
647 & 649 Base Kit	41
647C Base Kit	42

## Table of Contents (continued)

	<u>Page</u>
Drain Fill Kit	42
Pump Manifold	43
647 & 649 Moisture Sensors and Hoses	44
647C Moisture Sensors and Hoses	45
Control Box and Wiring Harnesses	46
Optional iPad Mini Mounting Kit (030-2012MK)	47
Optional iPad Display Kit (030-2670DK)	48
<b>Baler specific installation kits</b>	<b>49-57</b>
Model 447-SO	49
Model 647C	50
Model 4503B	51
Model 4504B	52
Model 4505B	53
Model 4508B	54
Model 4517B	55
Model 4523B	56
Model 4524B	57
Model 4547B	58
<b>Selecting Tips-Reference Guide</b>	<b>58-59</b>
647 & 649 Tip Selection Guide	59
647C Tip Selection Guide	60
<b>Notes</b>	<b>61-62</b>
<b>Warranty statement</b>	<b>63</b>

## Introduction

Thank you for purchasing a Harvest Tec Model 663 Moisture Monitor System. This 663 Moisture Monitoring System has been designed to be operated through an Apple iPad (not included) using the Hay App. As well as the option to plug directly into most tractors that have an ISOBUS Monitor. The 663 Moisture Monitoring System offers these advantages by operating through an Apple iPad:

1. Large bright, clear, colorful display
2. More durable and can be read in bright sunlight
3. Wireless connection in cab
4. Can be used for multiple other uses than just the applicator display
5. Option to tie-into the tractor ISOBUS system

The 663 Hay Preservative Applicator System is designed to apply buffered propionic acid to the forage crop as it is baled and will adjust the rate of application based on moisture and tonnage of the crop being harvested. This manual will take you through the steps for installing the applicator. If you are unsure about installing the system after consulting this manual, contact your local authorized dealership for additional assistance. This applicator is designed to apply Harvest Tec buffered propionic acid.

Left and Right sides are determined by facing in the direction of forward travel.

## **System Requirements**

***\*iPad Mini or iPad 3rd Generation (2012) or newer, running the current iOS operating system or one version previous required for iPad option***

*If choosing to operate the unit through the ISOBUS monitor, part number 006-6670A will need to be ordered through your local equipment dealer.*

## Model Reference Chart

<b>Baler make</b>	<b>Baler Model</b>	<b>Model</b>	<b>Installation kit</b>	<b>Tank size</b>
Case IH	All RBX & RB series four ft wide	647	447-SO	25 gallon
Case IH	All RBX & RB series five feet wide	647	447-SO	55 gallon
New Holland	All BR balers four feet wide	647	447-SO	25 gallon
New Holland	All BR balers five feet wide	647	447-SO	55 gallon
AGCO	5446 – 5556 & 2646 - 2766	649	4508B	55 gallon
AGCO	2846-2856A	649	4524B	55 gallon
Challenger	RB 46 - 56	649	4508B	55 gallon
Challenger	RB453 - RB563A	649	4524B	55 gallon
Hesston	800 and 900 series round balers	649	4508B	55 gallon
John Deere	582 & 854 round balers	649	4503B	55 gallon
John Deere	5, 6, and 7 series round balers	649	4504B	55 gallon
John Deere	8 & 9 series round balers	649	4517B	55 gallon
John Deere	0 Series balers	649	4547B	55 gallon
Massey Ferguson	2646 – 2766	649	4508B	55 gallon
Massey Ferguson	2846-2856A	649	4524B	55 gallon
Vermeer	604M and 605M round balers	649	4505B	55 gallon
Roll Belt Round Baler	RBX & RB series 4 & 5 foot wide	647C	N/A	55 gallon

## Safety

Carefully read all the safety signs in this manual and on the applicator before use. Keep signs clean and in good working order. Replace missing or damaged safety signs. Replacement signs are available from your local authorized dealer. See your installation manual for under the replacement parts section for the correct part numbers. Keep your applicator in proper working condition. Unauthorized modifications to the applicator may impair the function and/or safety of the machine.

Carefully read and understand all of the baler safety signs before installing or servicing the baler. Always use the supplied safety equipment on the baler to service the applicator.

## Safety Decals

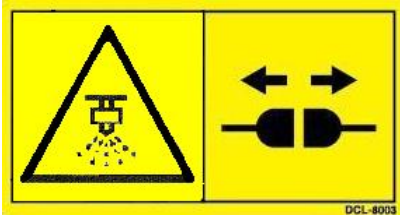

Number 1  
Spraying hazard. Disconnect power before servicing the applicator  
Part no. DCL-8003



Number 2  
Falling hazard. Do not step in this area.  
Part no. DCL-8002



Number 3  
Use caution when working around chemicals. **Wear all protective equipment according to the label of the product.**  
Part no. DCL-8001



Number 4  
Read and understand the operator's manual before using or working around the equipment.  
Part no. DCL-8000

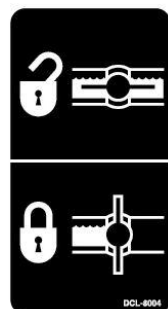

Number 5  
Open (unlocked) and closed (locked) position of the ball valve.  
Part no. DCL-8004

# Safety Decal Locations

## Model 647

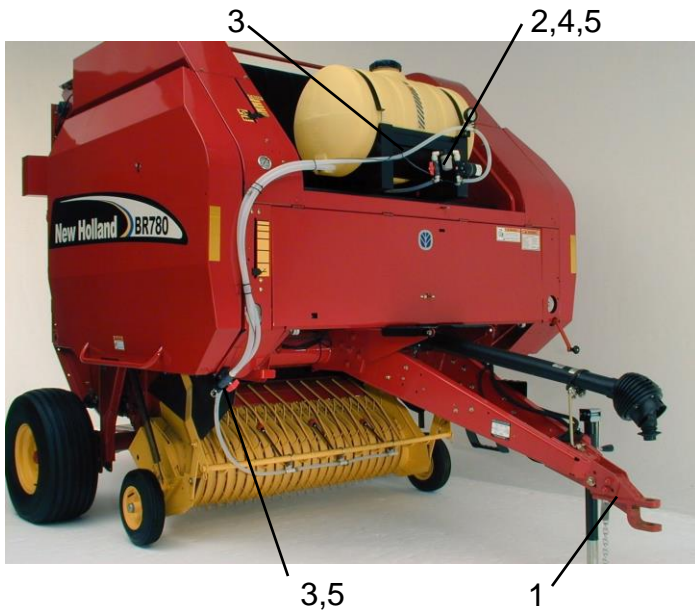

## Model 649



## Model 647C

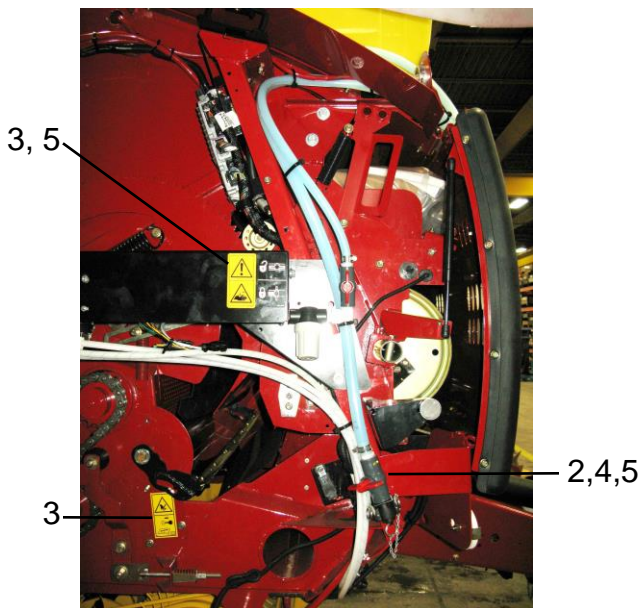



## Preparing the Applicator for Operation

After the applicator has been installed on the baler, follow the below steps to prepare for operating the applicator both safely and correctly.

### Filling the Tank

Read the label of the product being filled into the tank to determine what individual protective measures need to be taken. Locate the drain/fill line on the baler. Open the cam-couplers (A) and remove the protective plug (B). Insert the male coupler (found on transfer pump) into the female cam and close the cams (A). To open the ball valve (C) turn the handle so it is vertical. After the ball valve has been turned on switch the pump to the On position. Monitor the level on the tank visually and shut off the pump before over filling. Once the pump is turned off, close the ball valve and remove the male coupler. The handle of the ball valve (C) will be horizontal when closed. Reinstall the protective plug and close the cams. The Harvest Tec model 9212 or 9214 transfer pumps is recommended for this process.

Water is recommended for first time and annual start up procedures.



Drain/Fill line on the baler

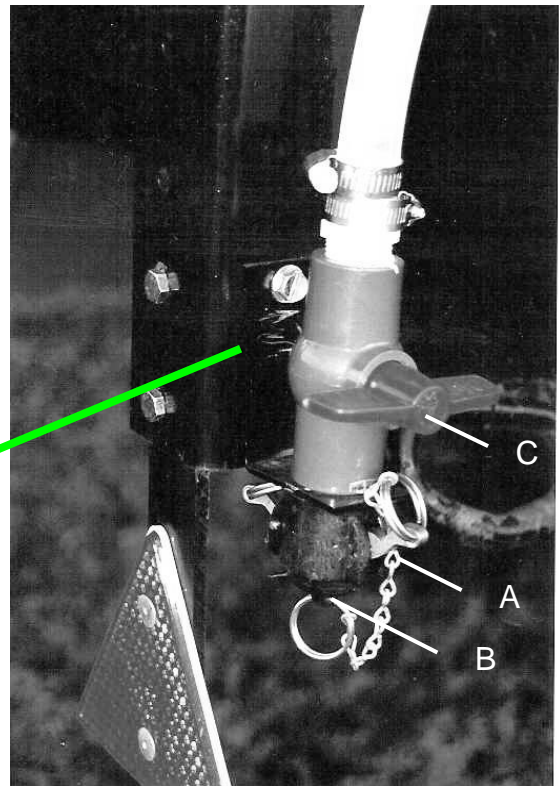

Enlarged view of the drain/fill line valve and cam-coupler assembly.



## Connecting Power and Communication Harness

The harnesses are located at the front of the baler near the hitch and at the back of the tractor near the drawbar. See arrow below. Make sure all connection wires are free between the hitch of the baler and the back of the tractor, especially when tractor is turning away.

**WARNING: Stop tractor engine and shift to park, set brakes and remove key before leaving the tractor.**

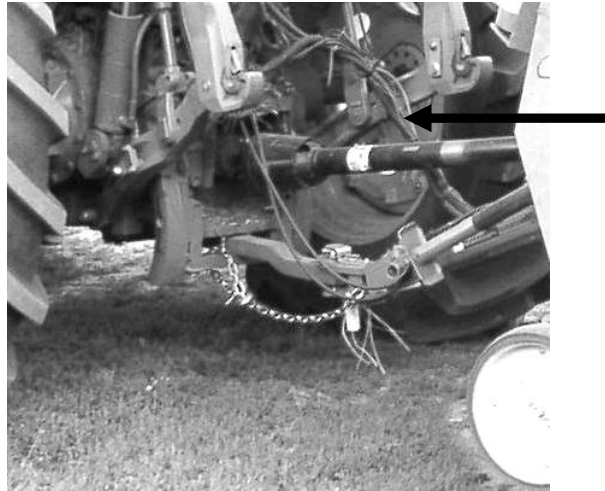

## Operation of the main ball valve

The ball valve should be closed at all times when the applicator is not being used. The valve should also be closed when any service work is being done to the baler or applicator.

The valve is located next to the pump and by the applicator tank. The arrow below points at the valve.

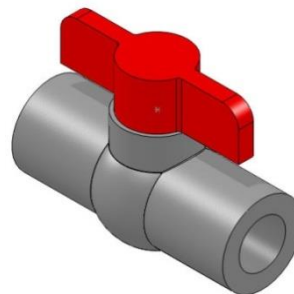
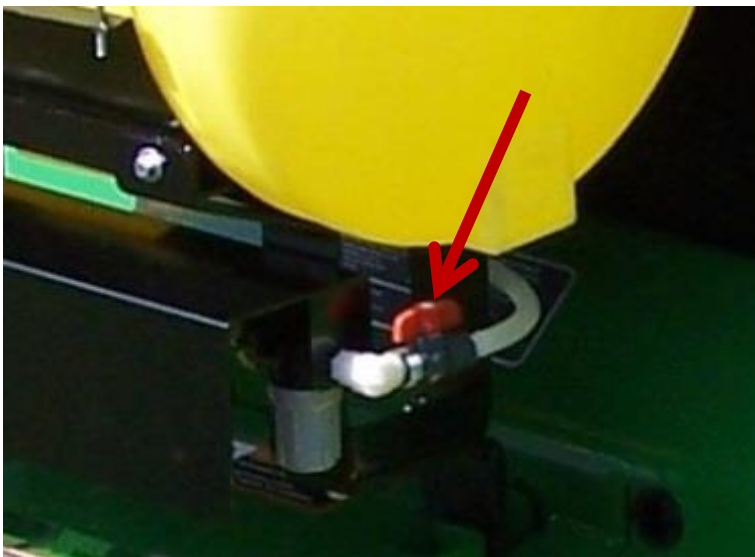

Valve open

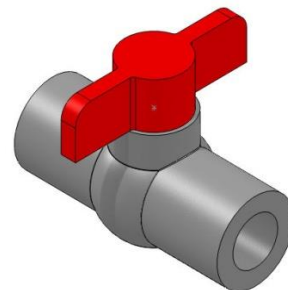

Valve closed

## Bluetooth Operation

### Turn On / Off iPad using the Sleep/Wake button

\*(Info from Apple User's Guide)

Turn iPad on. Hold down the Sleep/Wake button until Apple logo appears. iPad will take a moment to load.

You can lock iPad and put it to sleep when you're not using it. Locking iPad puts the display to sleep, saves the battery, and prevents anything from happening if you touch the screen.

Sleep/Wake Button



When you are not going to use the iPad for an extended period of time put the unit into sleep mode by pressing the Sleep/Wake button. Press Sleep/Wake button to wake iPad and then unlock iPad by entering passcode.

Turn iPad off. Hold down the Sleep/Wake button for a few seconds until the slider appears onscreen, then drag the slider to the right.

### Downloading Harvest Tec App

1. If iPad does not have Wi-Fi turned on, select the Settings tab  then select the Wi-Fi tab (below).

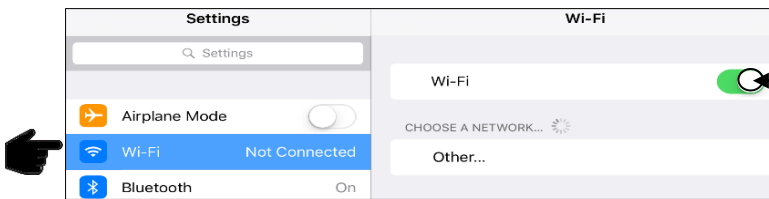

2. Turn Wi-Fi on by sliding button to the right.  
\*Green bar indicates ON

3. Use same process to turn on Bluetooth function

4. Select an available network when detected by the iPad, shown in area above that currently says 'Other.'

5. Select App Store icon (below) and open. \*You will need a Wi-Fi connection available to view App Store.



**\*\*The Harvest Tec system WILL NOT appear under the Bluetooth tab in the Setting App. Open the Hay App to connect.**

Download the Hay App in the App Store by searching for 'Hay App' in the search bar in the top right corner of screen (right):

\*The advertisements displayed on the App Store screen will change.

The app will have the icon as shown:



Hay App

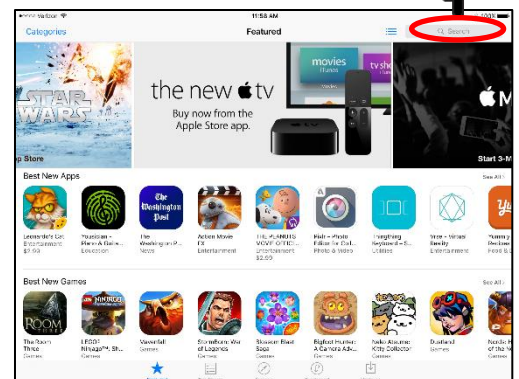

**Note:** Operation requires iPad Mini or iPad 3<sup>rd</sup> Generation (2012) or newer, running the current iOS operating system or one version previous required for iPad option.

## Shutting Down the Hay App

To shut down the Hay App double click the home button (Figure A). This will show the open apps that are running on your iPad (Figure B).

\*Note: By pressing the home button one time to return to the home screen, the Hay App **does not** shut down. The system will however, stop applying preservative after 10 seconds.



Figure A

Slide the app you want to shut down by sliding the app toward the top of the iPad, until the app is no longer visible (Figure C).

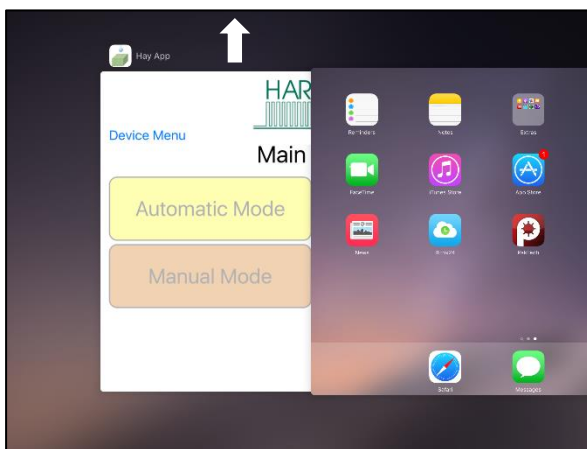

Figure B

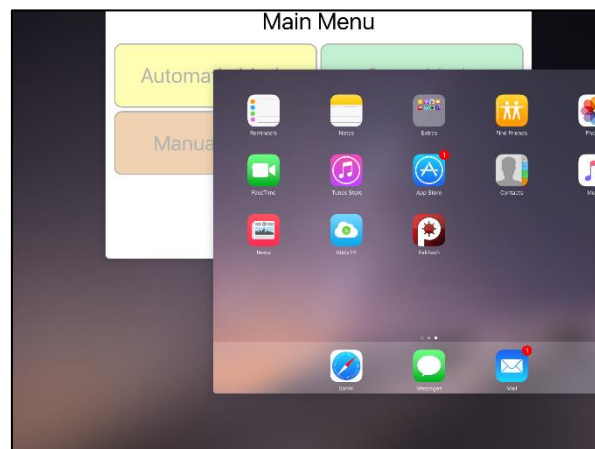

Figure C

## Bluetooth Receiver

\*New for production year 2018. All Bluetooth receivers (030-6672B) are now equipped with lights to indicate both power and iPad connection.

*Blinking Lights* – System is waiting for the processor to connect, which could take up to 35 seconds.

*Red Light* – The Bluetooth receiver has power

*Green Light* – When the proper active connection is selected in the Hay App menu, the green light will indicate connection with the iPad.



## Operating the Harvest Tec iPad App (continued)

When ready to operate your applicator system, open the Hay App on the iPad by selecting the Hay App icon.

*\*Use the following information for Round Balers.*

### Device Selection

The app will open to the Device Menu screen as shown below. Applicators which are equipped with the Bluetooth receiver that are within range (20') of the iPad and have power going to them, will be shown under the Active Connections section.

After the iPad connects to the Bluetooth receiver, select the applicator you want to connect with.

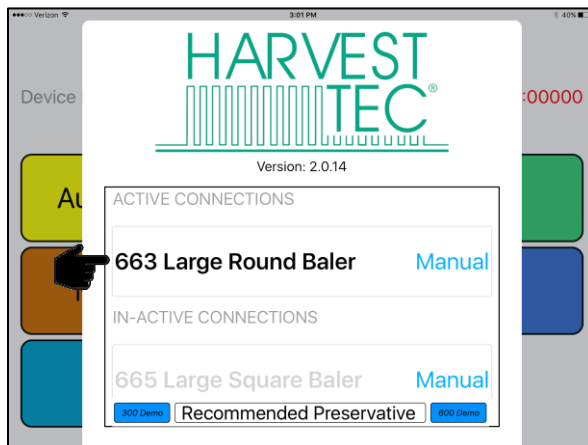

The In-Active Connections section will show applicator systems that have been connected in the past, but are not within range of the iPad or do not currently have power going to them (bottom left).

To remove a baler from the In-Active list, slide the bar displaying the baler name to the left, and select the Delete button that will appear (bottom right).

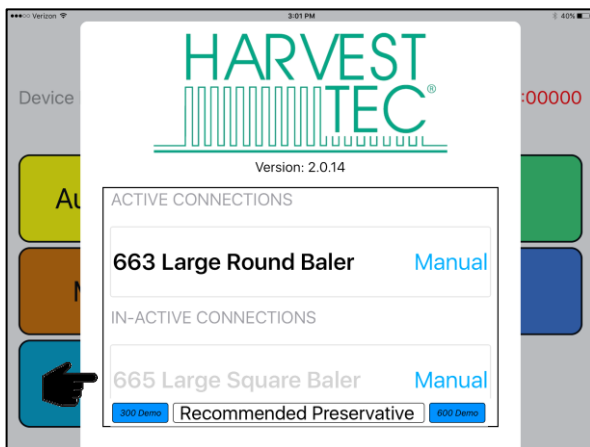

Figure B

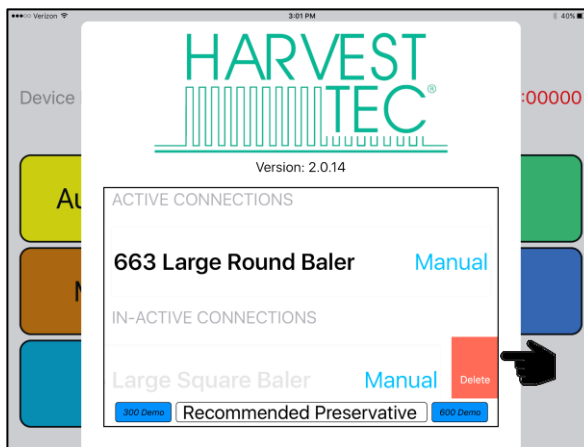

Figure C

## Operating the Harvest Tec iPad App (continued)

### Demo Mode

Selecting the 300 Demo or 600 Demo button (below) will allow you to view the different screens of the applicator without requiring connection to an applicator system.

\*This function is intended to be used as a visual aid, no values will be displayed.

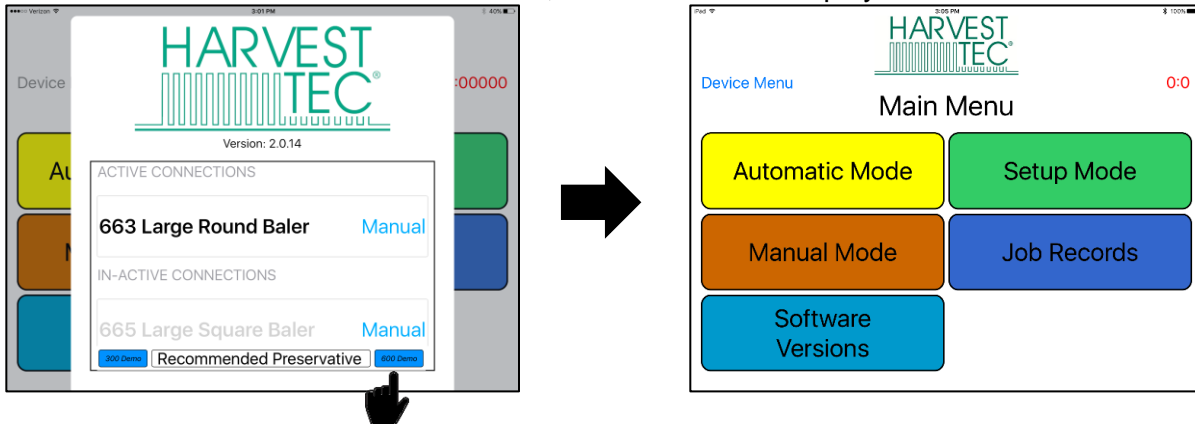

### Manual Selection

Selecting the Manual button (below) displayed to the right of the baler name will open the operation manual for your baler.

\*You do not need to be connected to a baler to open the manual and recommended preservative tabs after a baler has been connected.

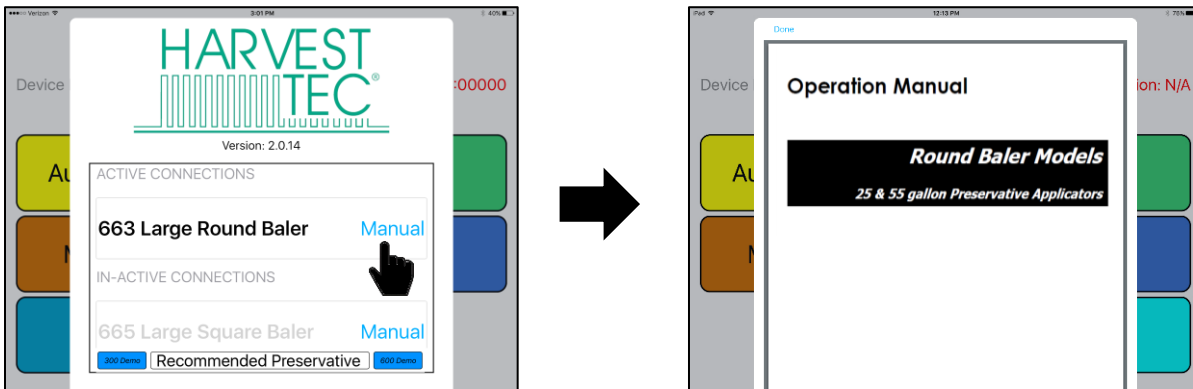

### Recommended Preservative

To view recommended preservative information, application rates, and frequently asked preservative questions, select Recommended Preservative (below).

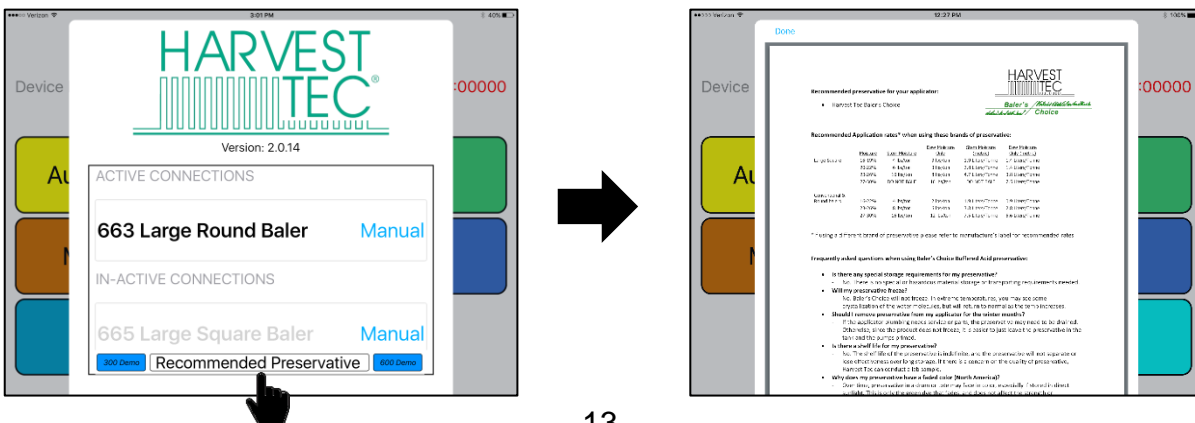

## Operating the Harvest Tec iPad App (continued)

Once you have selected the baler you want to connect with from the Device Menu, the applicator main menu will display (below).

Ensure the iPad Bluetooth function is turned on in the Settings App.

\*The applicator system will not appear under the Bluetooth Devices in the Settings App upon initial connection. You must open the Hay App to view the available devices by selecting the Device Menu. After you have connected through the Hay App, the system will then appear under the Bluetooth Devices in the Settings App.

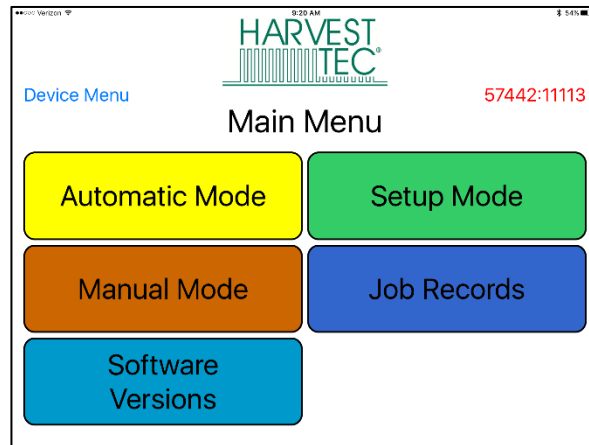

### Tab Descriptions

**Automatic Mode:** This mode allows you to use all of the applicator features such as adjusting preservative application on the go and counting total pounds of product used.

**Manual Mode:** Allows operator to manually turn pumps on and off. This mode also has moisture content displayed. Use this mode to prime pumps.

**Software Versions:** Selecting this tab will display the software currently installed.

**Setup Mode:** This mode allows the operator to adjust bale rate, application rate settings and select tip output.

**Job Records:** Keep track of up to 300 jobs with total product used, average moisture content, tons baled, and baling date.

## Screen Menus

Use the screen shots below to navigate through the operation screens.

### Automatic Mode.

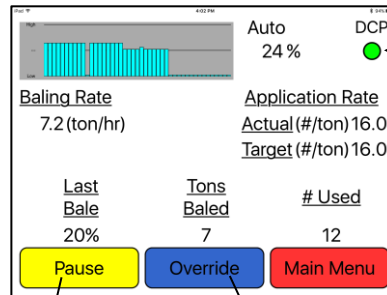
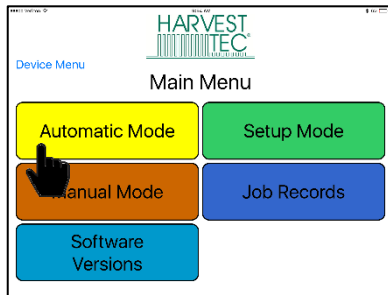

Bluetooth Connection Indicator  
 Green -DCP is connected  
 Yellow -DCP connecting  
 Red -DCP not connected

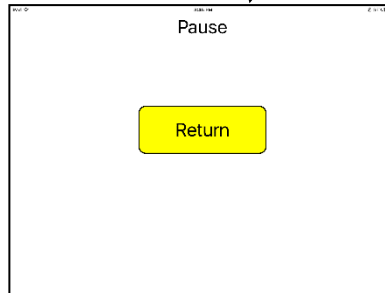

### Manual Mode

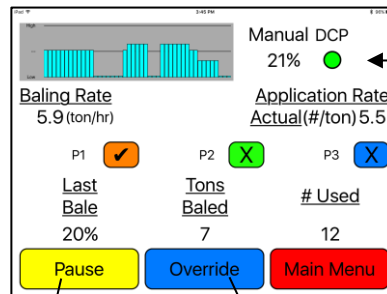
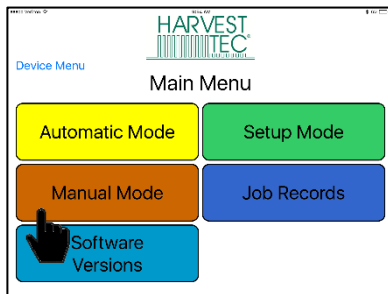

Bluetooth Connection Indicator  
 Green -DCP is connected  
 Yellow -DCP connecting  
 Red -DCP not connected

X -Pump is OFF  
 ✓ -Pump is ON

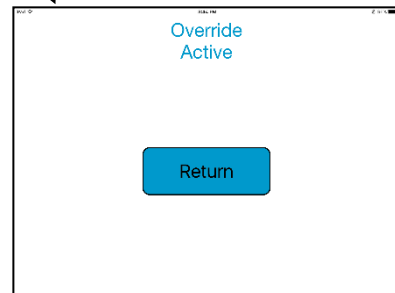
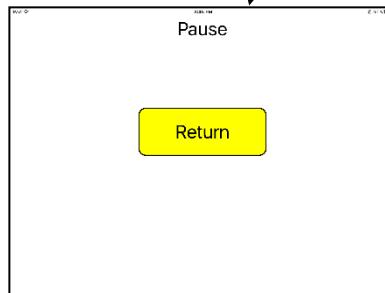

### Operation Note:

Pressing the Home Button on the iPad **WILL NOT** immediately stop application of preservative. (see below):

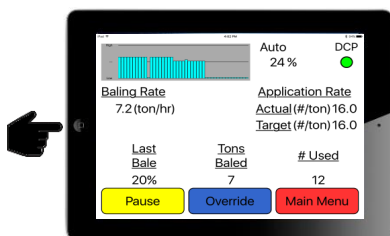

Select **Pause** or **Main Menu** to stop application.

\*Pressing the home button will cause the system to stop application after 10 seconds.



# Setup Mode

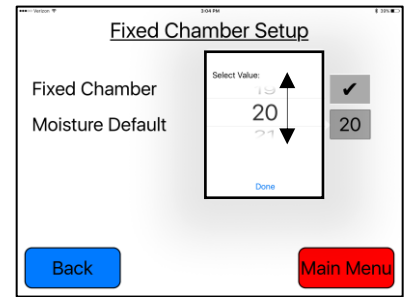
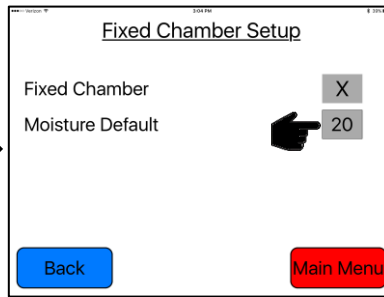
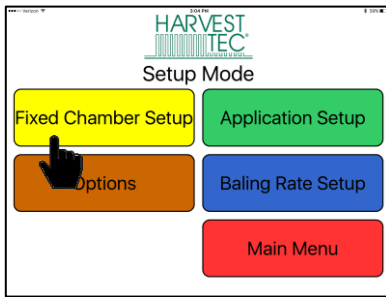
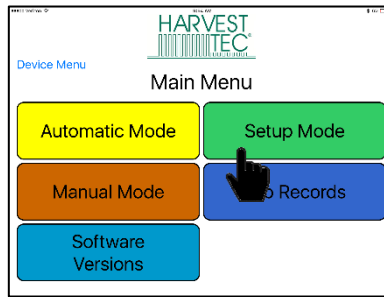

If using a fixed chamber baler, select the X to turn on

Adjust the moisture default to the moisture of the last bale reading

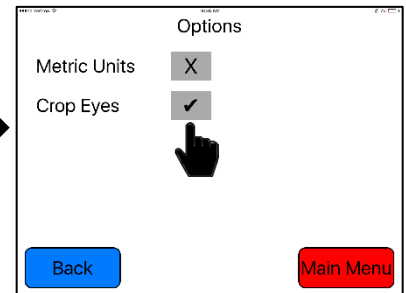
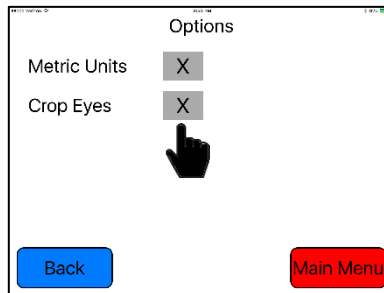
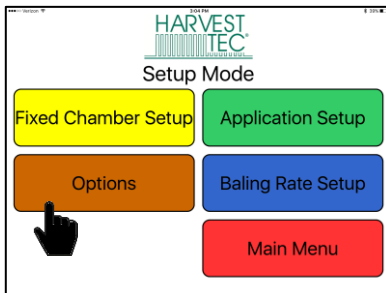

\*Select X to turn on options shown

✓ Indicates Crop Eyes are ON

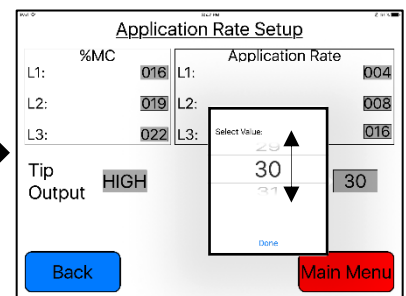
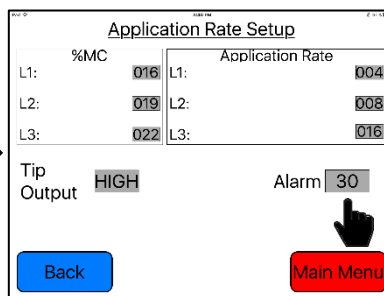
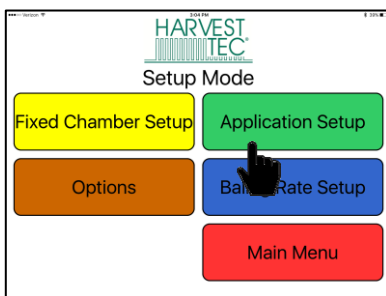

Adjust moisture alarm to desired level

Select desired alarm moisture

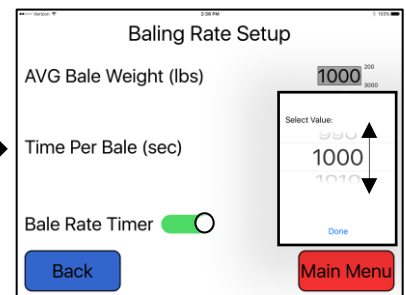
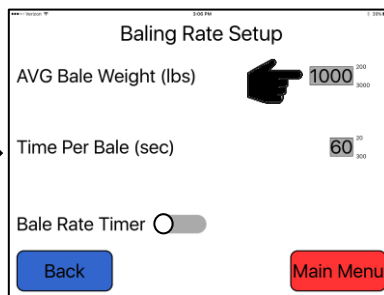
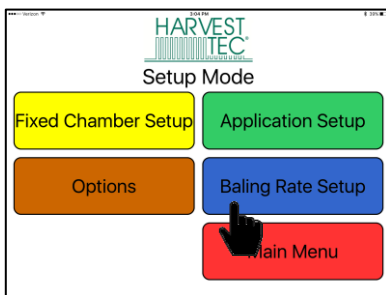

Adjust bale weight information

Select desired bale weight

# Job Records

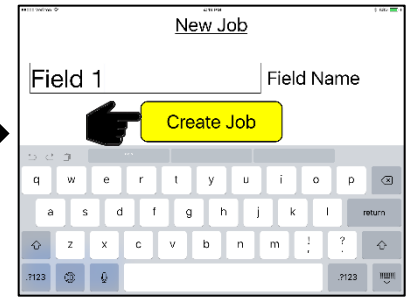
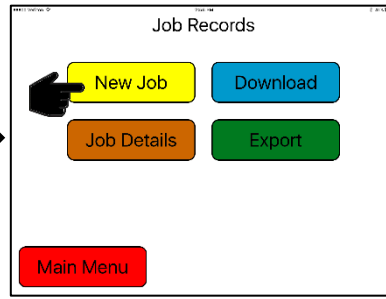
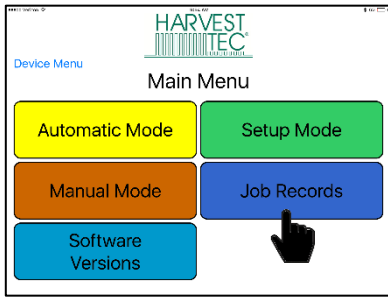

Type desired Field Name, select Create Job

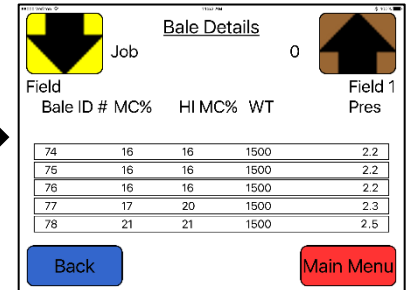
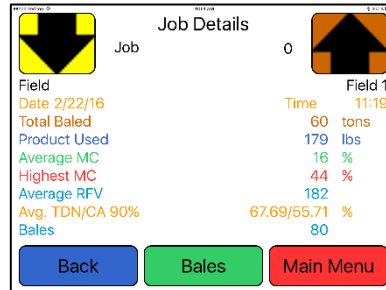
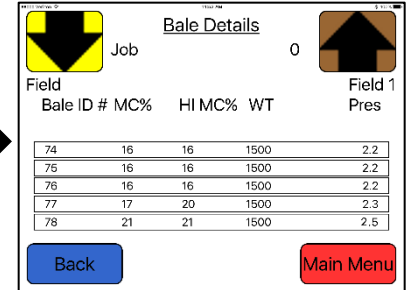
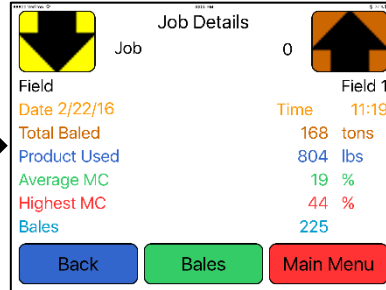
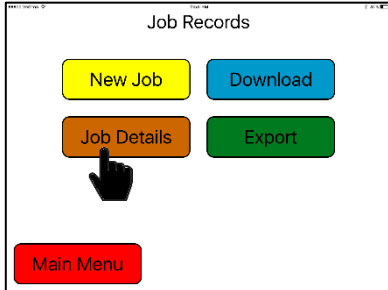

\*When RFV Equipped, Average RFV, Ave TDN/CA90% info will be added

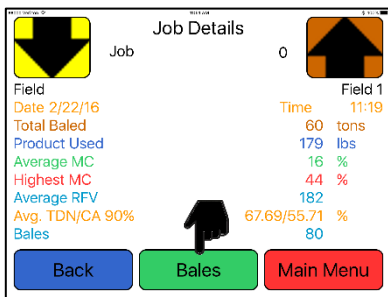

For Bale details select Bale Button

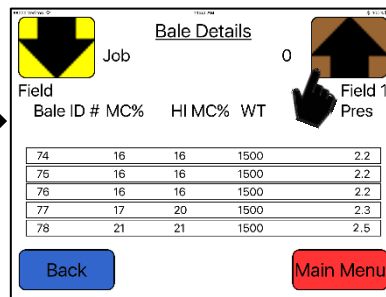

Use arrows to change jobs shown

# Job Records (continued)

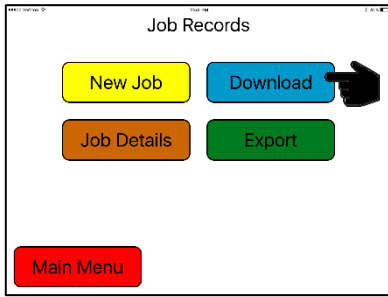

Select Download when wanting to download job records to USB Stick

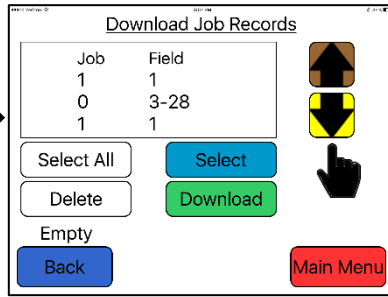

Use arrows to change jobs shown.   
 ↙ Indicates selected jobs

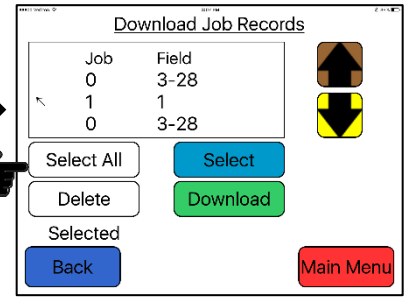

Pressing the Select or Select All tab to choose which job to download or delete.

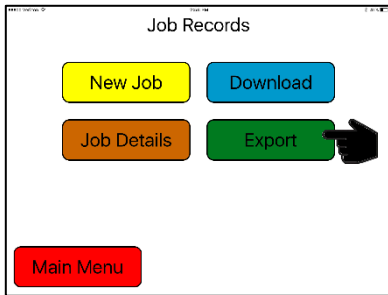

The Export allows you to send an email file with selected job records



When the Export page is opened the bale information is retrieved.

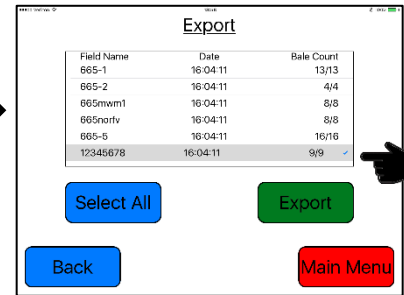

When all bales have been retrieved, Export tab will activate, select a job(s)



If choosing one job to email, select the Mail tab. Multiple jobs can be selected

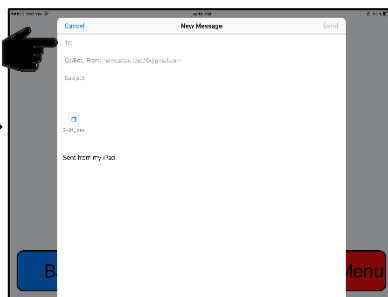

Email will appear w/file attached, enter address \*If two or more jobs selected, email will appear

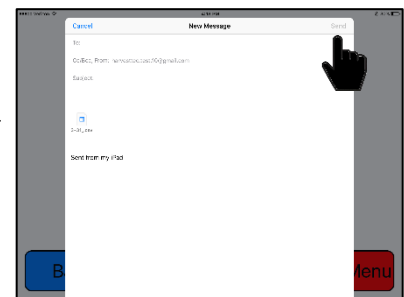

Press the Send button in top right corner, (your iPad notification sound will play)



If choosing to view job on iPad, recommended to download Excel app to view job records information

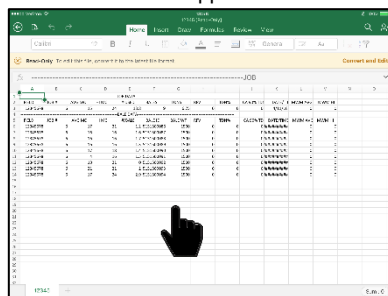

After Excel app is selected, the job record spreadsheet will open  
\*iPad can only view 1 job at a time.

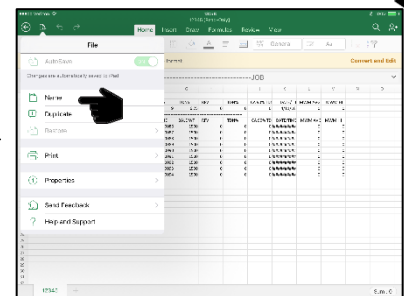

To save the job, select Name from the drop down tab

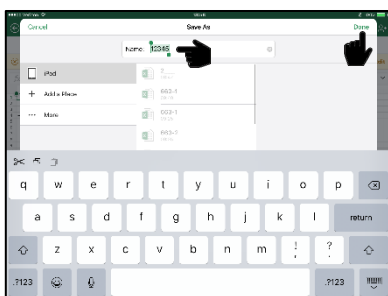

Enter desired name in center of page and press Save on the top right corner

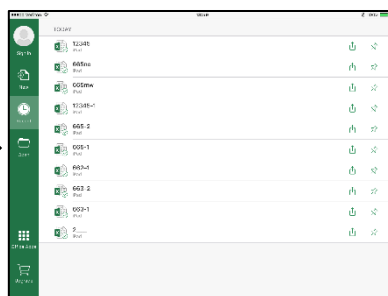

After selecting Save, list of saved files in Excel will appear. Select job to view

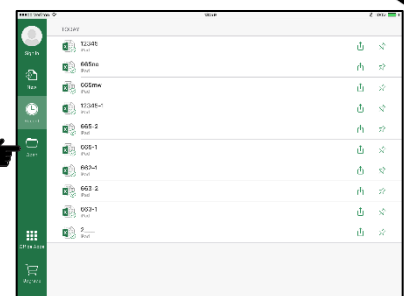

Also can view the jobs saved by selecting Open tab after opening the Excel app

## First Time and Annual Startup Instructions

### THE UNIT MUST BE CHECKED OUT BEFORE FIELD OPERATION!

#### Check and Prime the Pumps

1. Put 10 gal (5L) of water in tank and turn main ball valve on.
2. Inspect for any leaks or drips at this time. If any are found tighten or replace area or fitting.
3. Turn controller on.
4. Press the SETUP MODE key make sure the AVG Bale weight is 1500 lbs (680kg), and Time Per Bale is 60 seconds. Press the MAIN MENU key to return to the opening screen.
5. Press the MANUAL MODE key and the screen shown below will appear.

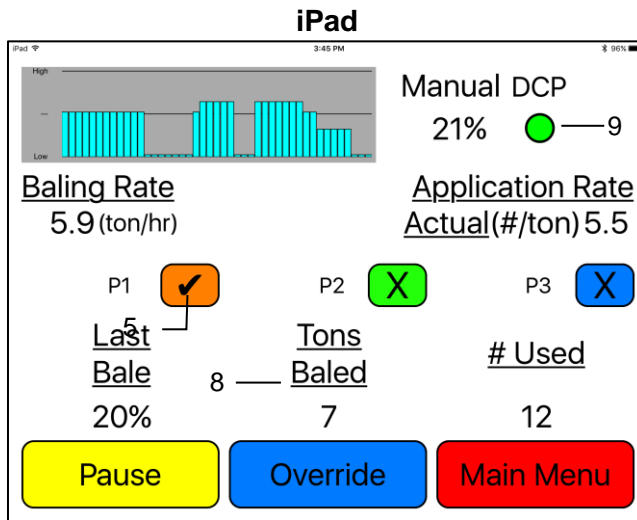

**Note: The system comes with the high tips already installed on the spray shield or nozzle tubes. Test the system with the tips you will use most often.**

Pump	Low Tips Output (Lbs / Ton) (L/MT)	High Tips Output (Lbs / Ton) (L/MT)
1	0.7 – 1.2 (.3 - .5L)	1.3 – 1.9 (.6 - .9L)
2	1.7 – 2.4 (.7 - 1.1L)	2.6 – 3.6 (1.2 - 1.6L)
3	2.5 – 3.5 (1.2 - 1.6L)	4.9 – 6.8 (2.2 - 3.0L)

6. Turn pump 1 on (P1). To turn the pump on, select the colored box next to P1 and change the 'X' to a check mark Repeat the process for pumps 2 and 3 (P2 and P3).
7. This process will also be used to prime the pumps whenever needed.
8. While running pumps check for a good spray pattern out of the respective tips and verify that no parts of the system are leaking.
9. While doing these tests the Volume Used on the bottom of the screen will be increasing, this verifies that the flow meter is functioning.
10. The DCP button displays your connection signal with the Bluetooth receiver. Green – DCP is connected, Yellow – DCP is connecting, Red – DCP not connected. Pressing MAIN MENU key to return to the initial startup screen.

## Setting Up the System for initial use with the iPad

In this mode you will setup your initial application rate and baling rate.

### Application Rate

After pushing the SETUP MODE key in the Main Menu screen, the top left screen will appear:

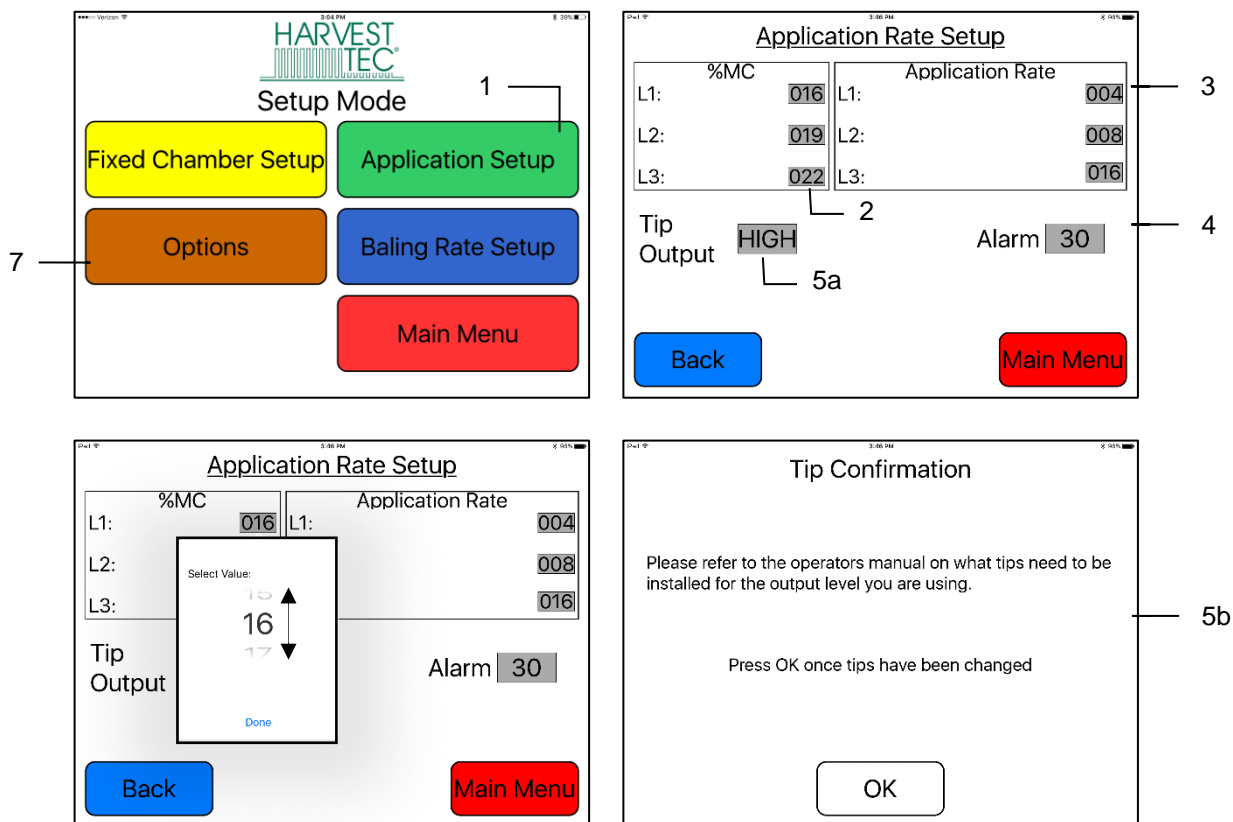

1. On the Setup Mode screen press the APPLICATION RATE key. Once selected the SETUP APPLICATION RATE screen will be shown. (Top right picture)
2. Press any of the grey number values to the right of %MC to adjust their figures. The scroll pad shown on the bottom left will display. Remember level 1 must be lower than level 2 and level 2 must be lower than level 3. Press Done, when value has been selected. Harvest Tec products recommend set points of 16, 22, and 26 % MC levels. These are preset from the factory. Press Back to return.
3. To change rate of chemical application, press any of the grey number values to the right of RATE. Remember level 1 must be lower than level 2 and level 2 must be lower than level 3. Press Done, when value has been selected. Harvest Tec products recommend rates of 4, 8, and 16 lbs/ton (2,3,5 L/MT). These rates are preset from the factory. Press Back to return to previous screen. **IT IS THE OPERATORS RESPONSIBILITY TO FOLLOW THE RECOMMENDATIONS OF THE PRESERVATIVE. ONLY THE OPERATOR CAN APPLY THE PROPER RATE.**
4. To set the alarm, press the grey number value and set the level at which you want the alarm to activate. To turn the alarm off, set level above 50.
5. Press the grey area next to Tip Output to **cycle between the high and low sets of tips** (5a). Use the correct tip set for the field conditions. The tip confirmation screen will appear (5b). Press OK once tips are changed.
6. Next press the BACK key found on the bottom left hand figure of the screen to return to SETUP MODE screen or press MAIN MENU key on bottom right hand figure of the screen to return to opening screen.
7. Press OPTIONS to adjust the unit between metric and standard units.

## Baling Rate Settings – Round Balers

### iPad Operation

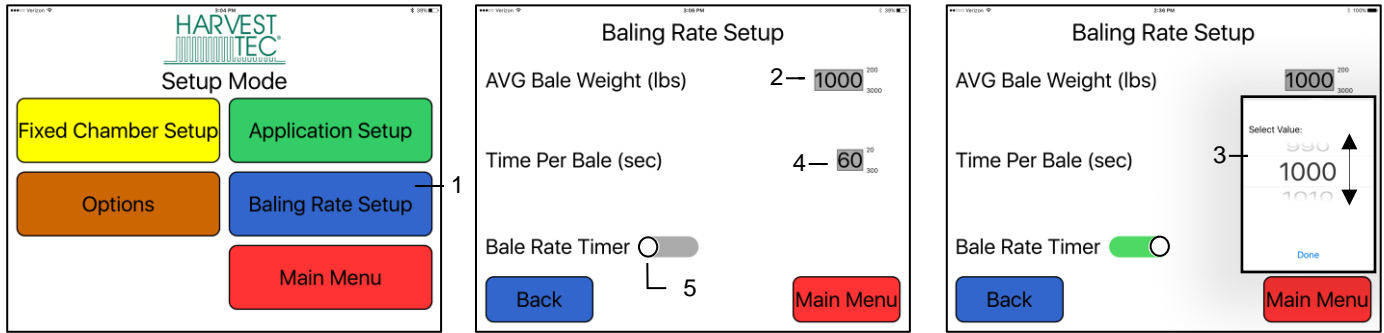

1. On the setup mode screen press the BALING RATE key.
2. Press the grey number value to the right of AVG Bale Weight (Lbs). To adjust the weight of your bales, the scroll tool shown on the right will display.
3. Scroll through the values to select correct information, press DONE when value has been selected.
4. Use the same procedure for adjusting time per bale.  
Note: Only count time that hay is coming into the baler, do not count tie time or drive time.

### Fixed Chamber Setup

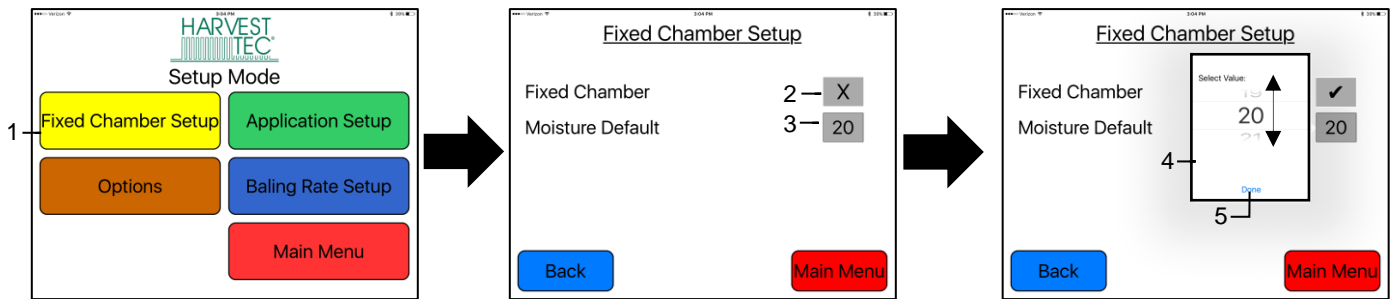

1. Press the Fixed Chamber Setup tab
2. If using a fixed chamber baler, select the X to turn the feature on. The ✓ indicates ON.
3. When using a fixed chamber baler, select the moisture default reading to adjust.
4. Adjust the moisture level to the previous bale moisture, by scrolling up or down to the desired level.
5. Press the Done key to save this information. The information will remain until it is changed again. The moisture default number needs to be set for the highest moisture that will be found in the bale. The moisture default will be the moisture setting used for the first half of the bale formation. During the second half of the bale formation the system will utilize the moisture discs to adjust the moisture reading every three seconds.
  - a. The first half of the next bale will use the average moisture readings from the previous bale, until the moisture discs can take a reading and adjust accordingly; during the second half of bale.

- The Bale Rate Timer needs to always be set to ON when operating in Fixed Chamber mode.
- If the Bale Rate Timer is set to OFF and in Fixed Chamber mode the system will **only** use the default moisture level for the entire bale and the tons/hour that is set up in the Baling Rate screen. Once the Bale Rate Timer is set to ON the system will return to normal operation.

\*The Fixed Chamber function is designed to operate in Automatic Mode ONLY. If operator chooses to run in Manual mode with Fixed Chamber turned ON the moisture readings will not be accurate.

## Operation Instructions

Automatic mode will automatically apply product based on hay moisture content sensed by the moisture sensors and the operator's presets. See SETTING UP SYSTEM FOR INITIAL USE to change any of these settings. **Manual mode will apply preservative to the hay at a fixed rate regardless of the moisture.**

### Automatic Mode

After pushing the AUTOMATIC MODE key in the Main Menu screen, the following screen will appear:

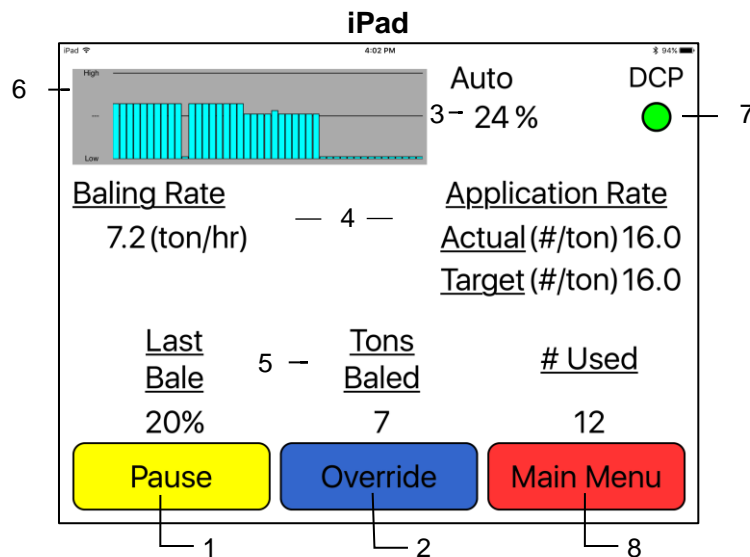

1. To pause the unit while in operation select the Pause key.
2. Push the OVERRIDE key to turn on all three pumps at the same time for full output of the system. Use this mode when going through a short area of wet crop.
3. The moisture content is shown in the upper right hand corner.
4. Baling Rate and Application Rate are shown in the middle of the screen. The operator sets the target application rate and baling rate in the setup mode; the actual rate should be within +/- one pound.
5. Volume used shown at the bottom of the screen will show accumulated pounds of preservative used on the go. This number will reset at power down, but remains in the job record screen. **NOTE: Initial start-up requires pressing the New Job key in the Job Records screen in order for Volume Used accumulation to be recorded. This only needs to be done once on initial start-up of system and not every time the system is started for operation.** (See JOB RECORDS screen)
6. The graph shows the moisture trend from the past 90 seconds in 3 second intervals.
7. The DCP button shown when using an iPad displays your connection signal with Bluetooth receiver. Green – DCP is connected, Yellow – DCP is connecting, Red – DCP not connected.
8. Press the MAIN MENU key to return to the opening screen.



## Manual Mode

After pushing the MANUAL MODE key in the Main Menu screen, the following screen will appear:

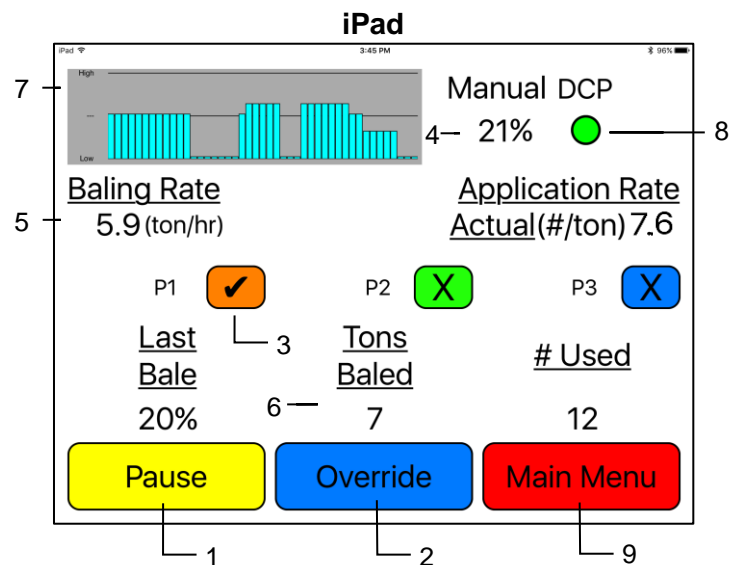

1. To pause the unit during operation select the Pause key.
2. Push the OVERRIDE key to turn on all three pumps at the same time for full output of the system. Use this mode when going through a short area of wet crop.
3. To turn the pump on, select the colored box next to P1 and change the 'X' to a check mark. In Manual Mode (regardless of moisture, baling rate or bale weight) the outputs are fixed rates as follows:

Pump	Low Tips Output (Lbs / HR) (L)	High Tips Output (Lbs / HR) (L)
1	45 (20L)	75 (34L)
2	90 (41L)	140 (64L)
3	135 (61L)	265 (120L)

4. The moisture content is shown in the upper right hand corner.
5. Baling rate and Application rate are shown in the middle of the screen. The output of a pump can be checked by dividing the preset output (shown in step 3) by the displayed baling rate. For example, if you have the low output tips in and are running pump one, by itself, your output is 45 lbs/hr. Given the baling rate shown on the above screen of 5.9 tons/hr, the application rate should be about 7.6 lbs/ton (45 lbs/hr divided by 5.9 tons/hr). The baling rate is set in the SETUP MODE menu.
6. Volume used shown at the bottom of the screen will show accumulated pounds of preservative used on the go. This number will reset at power down, but remains in the job record screen. **NOTE: Initial start-up requires pressing the New Job key in the Job Records screen in order for Volume Used accumulation to be recorded. This only needs to be done once on initial start-up of system and not every time the system is started.**
7. This graph shows the moisture trend from the last 90 seconds of baling (one every 3 seconds).
8. The DCP button shown displays your connection signal with Bluetooth receiver.  
Green – DCP is connected, Yellow – DCP is connecting, Red – DCP not connected.
9. Pressing MAIN MENU will return you to the opening screen.

## Job Records

After pushing the JOB RECORDS key in the Main Menu screen, the following screen will appear:

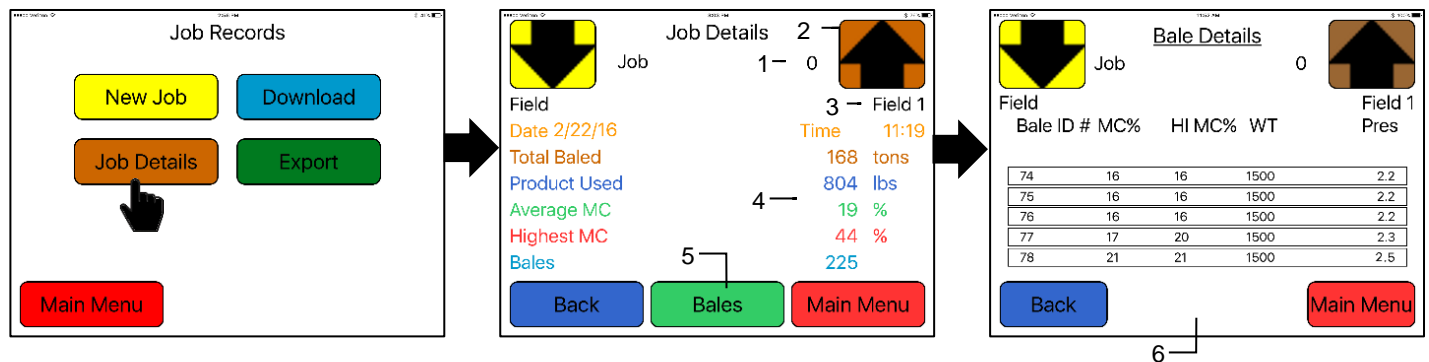

1. The job number will be displayed at the top center. The current job being viewed will always read "Job #: 0". Product used and average moisture content will be reset when the NEW JOB key is pressed. The job records screen will store up to 300 jobs allowing access previous jobs by using the up and down arrows.
2. Scrolling through previous jobs is done by pressing the UP or Down keys.
3. The field name is located under the up arrow.
4. The accumulated information from the field will be displayed in the middle of the screen. **Every time the NEW JOB key is pressed the accumulated pounds on auto and manual modes will be reset to zero.** After 300 jobs have been stored, the next time the NEW JOB key is pressed the system will start over with job one and the old job will be replaced.
5. Selecting the Bales button will open the Bale Details Screen.
6. The Bale Detail screen will display the individual bale information onto each line. Including Bale ID#, MC% (moisture percentage), HI MC% ( high moisture percentage), WT (weight of bale) and Pres (preservative used per bale).

**NOTE: Initial start-up requires pressing the New Job key in the Job Records screen in order for Volume Used accumulation to be recorded. This only needs to be done once on initial start-up of system and not every time the system is started for operation.**

## Download Job Records

After pushing the JOB RECORDS key in the Main Menu screen, the following screen will appear:

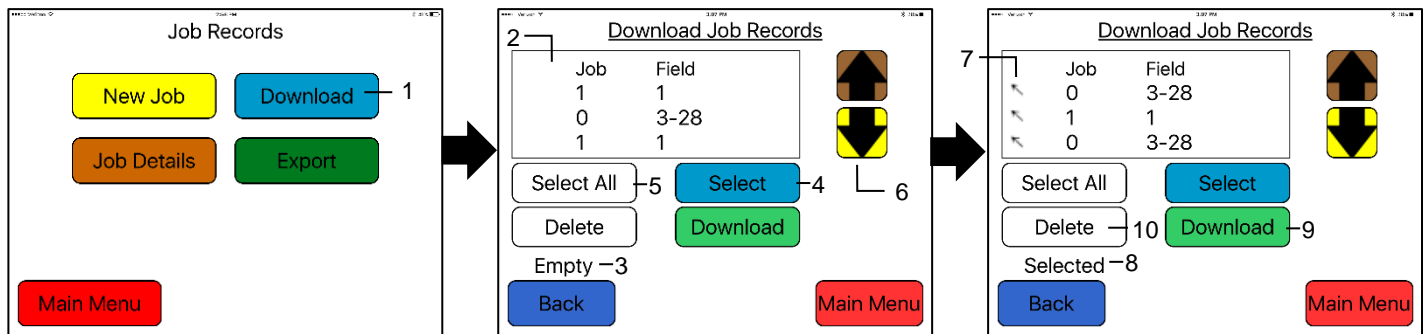

Prior to downloading job records a USB stick will need to be placed into the USB port on the applicator's Dual Channel Processor (DCP). Jobs will not be downloaded if the USB stick is plugged into the monitor.

1. To download the Job Records to a USB stick, select the Download button
2. The list of job records you have created, will display in the middle of the screen
3. When no jobs have been selected the status line will read Empty
4. To download individual job(s), tap the desired job(s) to be downloaded, or press the Select button
5. To select all of the jobs stored, press the Select All Button
6. Move through job records by selecting the up or down arrows
7. The ↖ indicates selected jobs to be downloaded
8. When chosen jobs have been selected the status line will read Selected
9. Press Download button to download job records to USB Stick. The status line will read Downloading
10. Delete selected jobs by pressing the Delete button

## Export Job Records (emailing records)

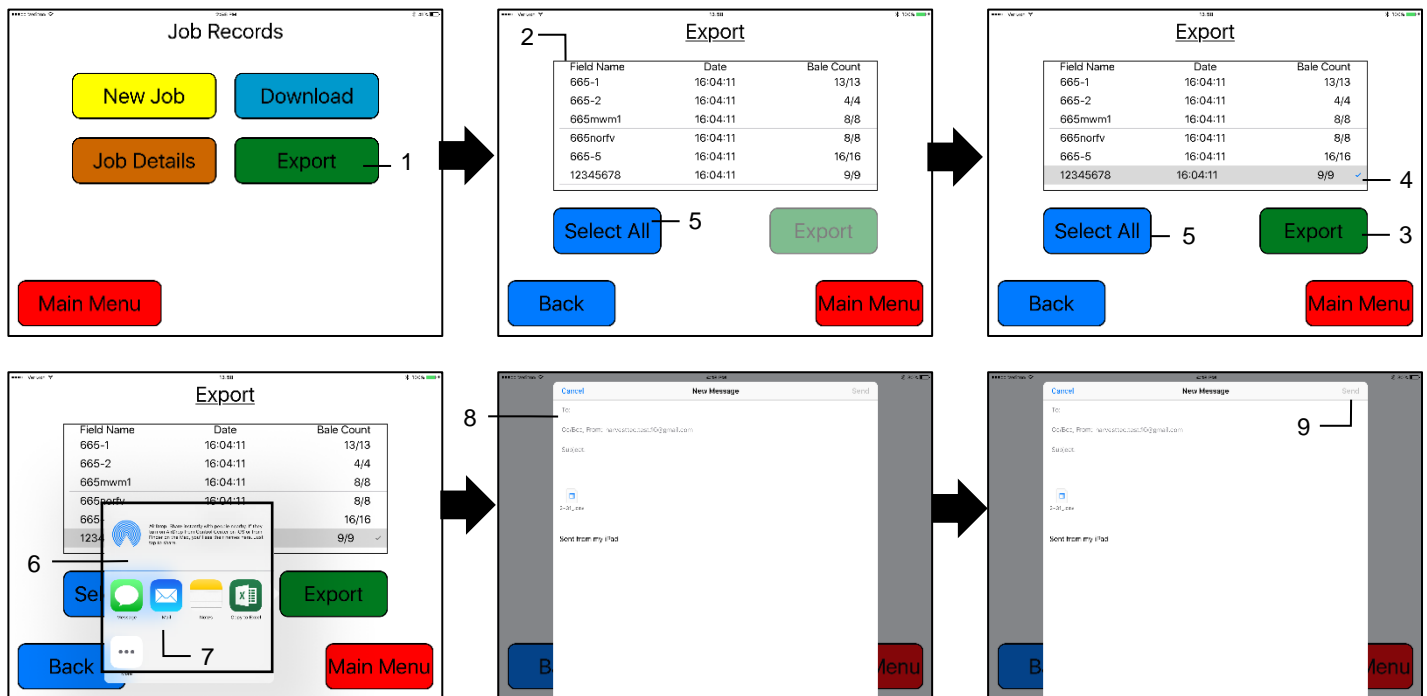

1. To export the Job Records through an email or save to the iPad select the Export button
2. The list of job records you have created, will display in the middle of the screen and the individual bale information will begin to download automatically. The number of bales will grow until equal to the number of bales available to export for each job record.
  - a. For example: When looking at a job record with 62 bales, the bale count will read 0/62 upon initially opening the page. The number will increase until it reads 62/62.
3. When all bales have been retrieved, the Export tab will become active
4. To export individual job(s), tap the desired job(s) to be exported. The ✓ indicated chosen job(s).
5. To select all of the jobs stored to be export, press the Select All Button
6. After selecting the Export tab, a small screen will appear with the mail app icon.
  - a. If selecting two or more jobs the email will automatically appear (skipping step 7)
7. Select the Mail app to open
8. Enter in the desired email address in the (To:) line of the email that will appear.
9. Press the send button to email the file to the email you have entered.

## Export Job Records (saving to iPad)

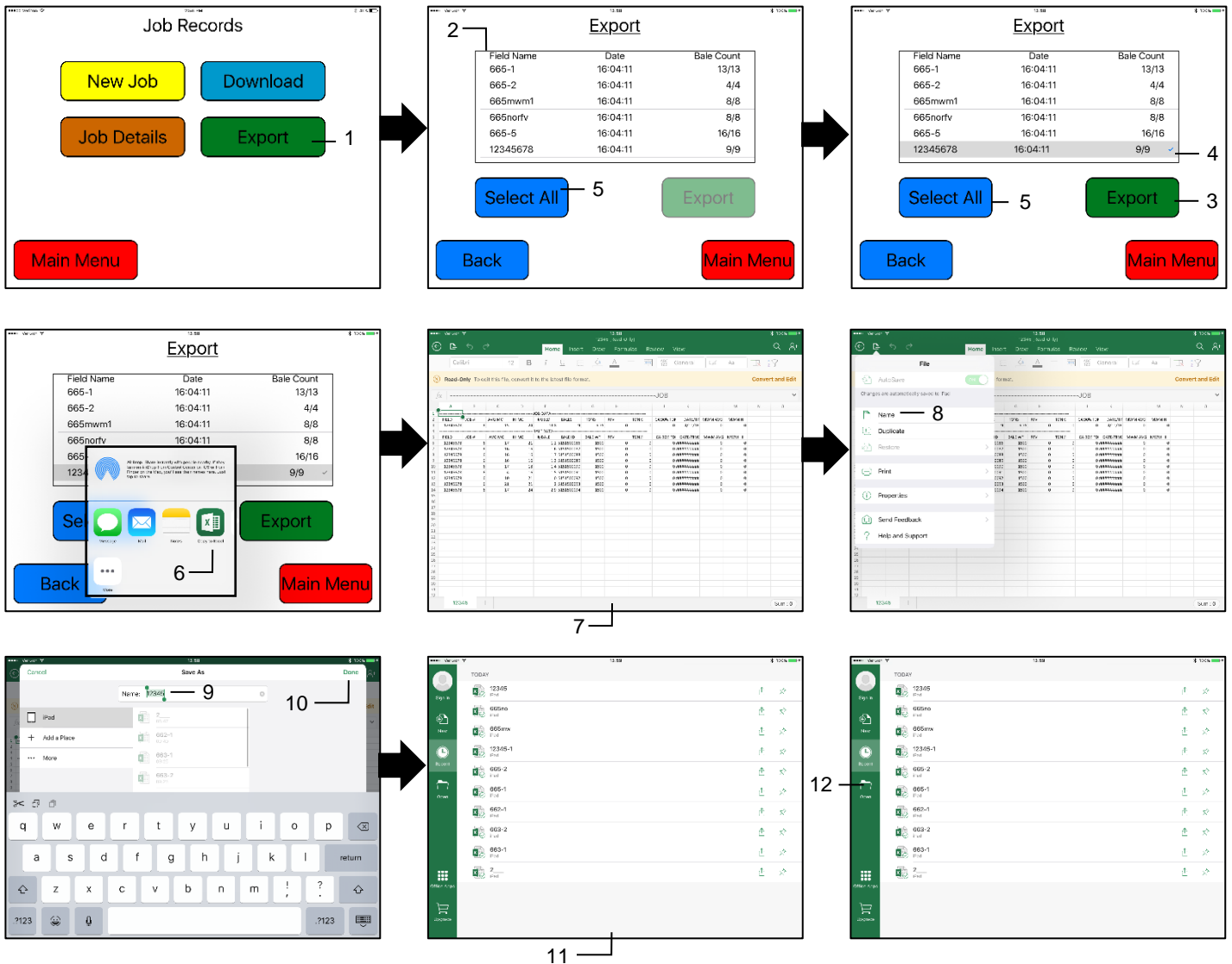

- To export the Job Records through an email or save to the iPad select the Export button
- The list of job records you have created, will display in the middle of the screen and the individual bale information will begin to download automatically. The number of bales will grow until equal to the number of bales available to export for each job record.
  - For example: When looking at a job record with 62 bales, the bale count will read 0/62 upon initially opening the page. The number will increase until it reads 62/62.
- When all bales have been retrieved, the Export tab will become active
- To export individual job(s), tap the desired job(s) to be exported. The ✓ indicated chosen job(s).
- To select all of the jobs stored to be export, press the Select All Button
- After selecting the Export tab, a small screen will appear with the Excel app icon.
  - It is recommended to download the Excel App to properly view the job records
    - Only one job can be selected at a time to view on iPad
- After the Excel app has been selected the job record spreadsheet will open
  - The iPad can only view one job at a time
- To save the job, select Name from the drop down tab
- Enter your desired file name
- Press the save button after entering your file name
- The list of saved files will appear
- You can also view the files by selecting the Open tab, when opening the Excel app

## 647 & 649 Wiring Diagram

1. Locate the tractor power/communication harness (006-6650TM).
2. On the back of tractor run the power leads of power / communication harness (006-6650TM) to battery.
3. Connect the red power wire with the 50 amp fuse to the positive side of the battery (12 volt).
  - a. **The power harness must be connected to the battery!** The unit will draw more amps than convenience outlets can handle. Any modifications of the power harness will void systems warranty. **CONTACT HARVEST TEC IF MODIFICATION IS REQUIRED!**
  - b. **This unit will not function on positive ground tractors.**
  - c. **If the unit loses power while operating it will not record accumulated product used.**
4. Connect the baler power and communication harness (006-6650LS) to the power port on the DCP and to the display port on the DCP.
5. Connect the Communication Harness (006-6650TM) to the Bluetooth Receiver (030-6672B).
6. Connect Pump Controller Harness (006-5650FC) to DCP and Pump Controller (006-5672).
7. Connect Flow Meter (006-4725A) and pump harness (006-4660Z) to the Pump Controller.
8. Install one terminating resistor to the pump controller (006-5650Z).
9. Attach moisture cable (006-4640G2) to the DCP

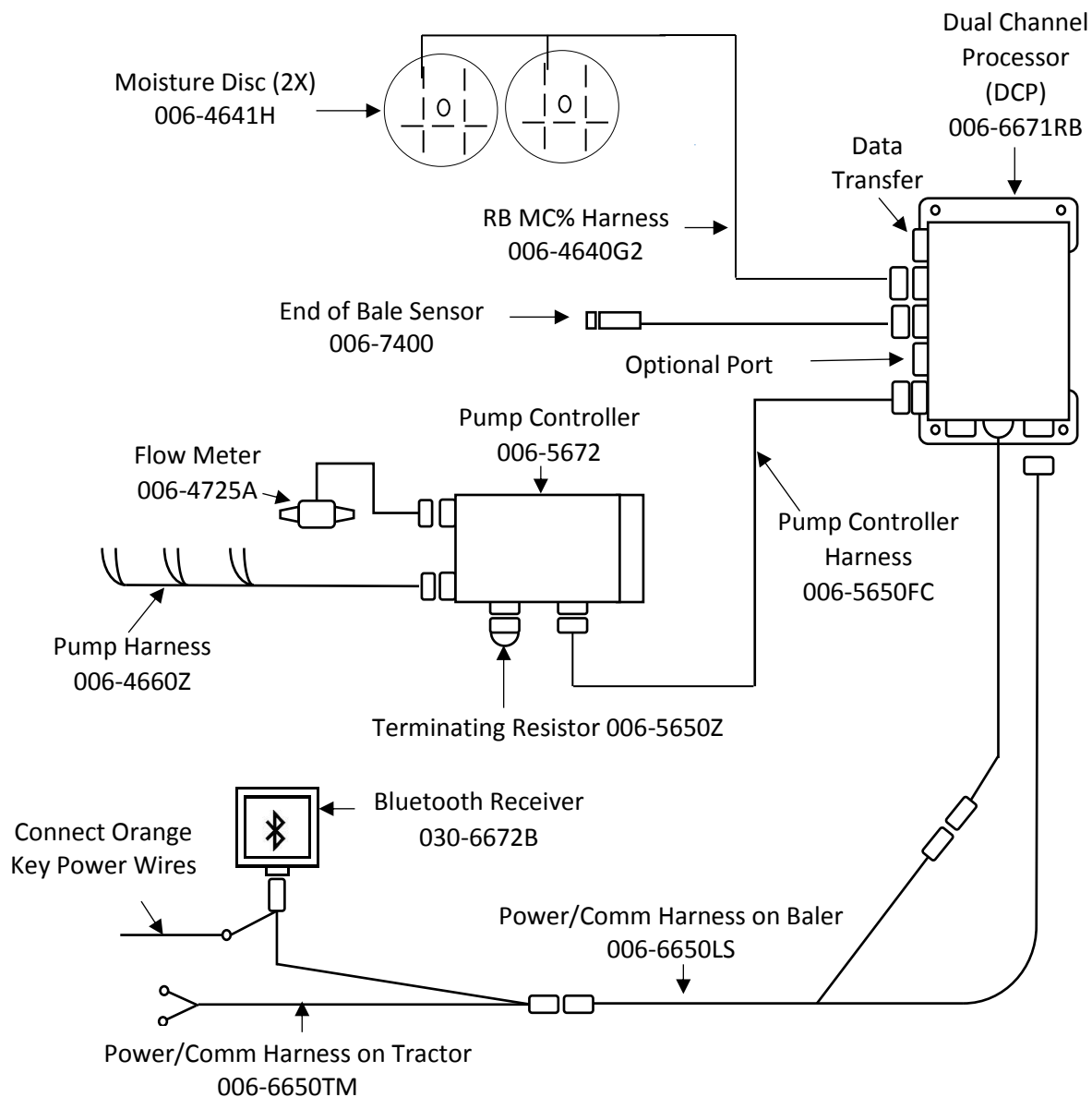

## 647C Wiring Diagram

1. Locate the tractor power/communication harness (006-6650TM).
2. On the back of tractor run the power leads of power / communication harness (006-6650TM) to battery.
3. Connect the red power wire with the 50 amp fuse to the positive side of the battery (12 volt).
  - a. **The power harness must be connected to the battery!** The unit will draw more amps than convenience outlets can handle. Any modifications of the power harness will void systems warranty. **CONTACT HARVEST TEC IF MODIFICATION IS REQUIRED!**
  - b. **This unit will not function on positive ground tractors.**
  - c. **If the unit loses power while operating it will not record accumulated product used.**
4. Connect the baler power and communication harness (006-6650LS) to the power port on the DCP and to the display port on the DCP.
5. Connect the Communication Harness (006-6650TM) to the Bluetooth Receiver (030-6672B).
6. Connect Pump Controller Harness (006-5650FC) to DCP and Pump Controller (006-5672).
7. Connect Flow Meter (006-4725A) and pump harness (006-4660Z) to the Pump Controller.
8. Install one terminating resistor to the pump controller (006-5650Z).
9. Attach moisture cable (006-4640G3) to the DCP

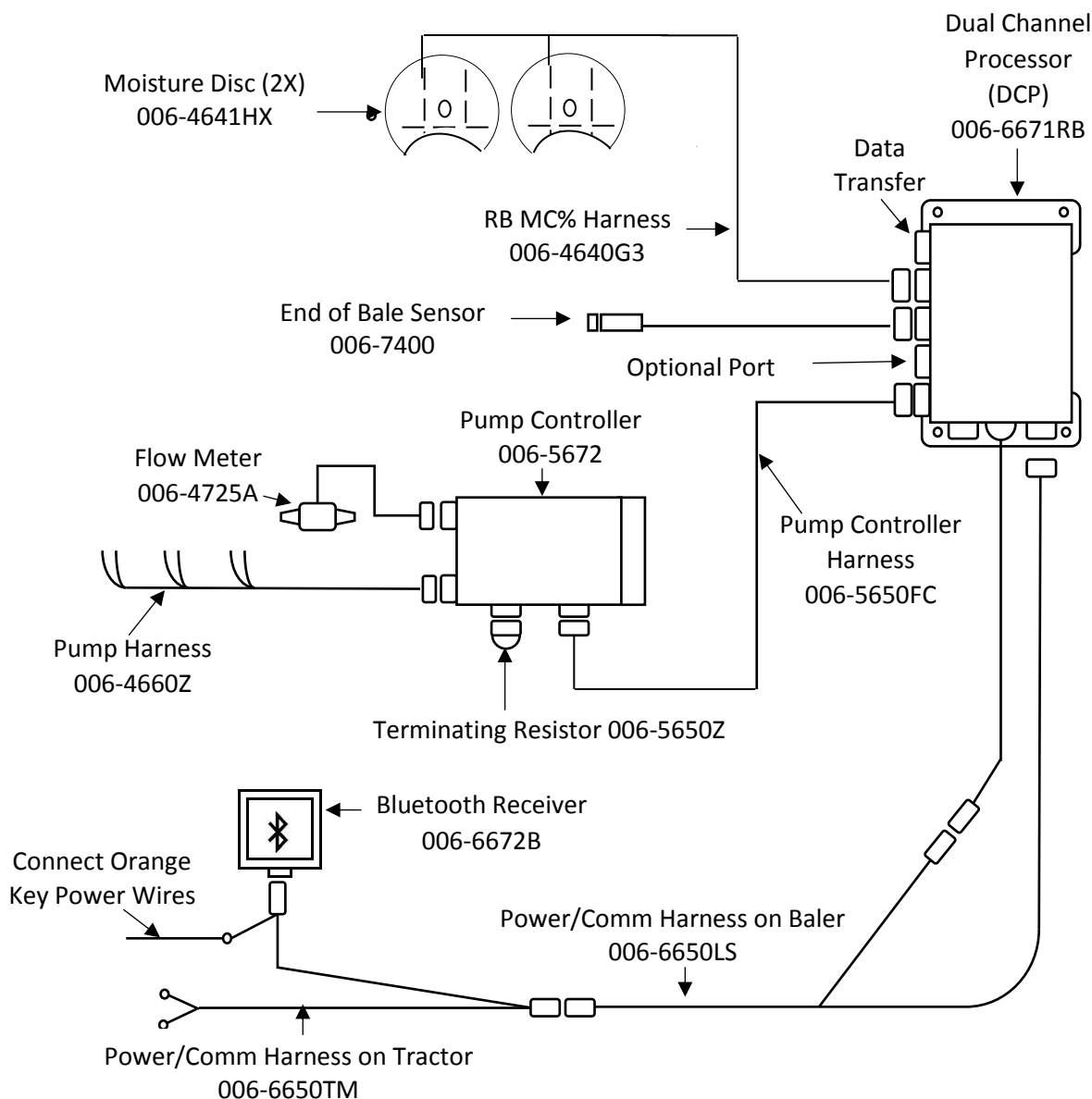



## Pin Outs

### Power/Comm Harness at Hitch

Pin 1	Red	+12V Power to TSD
Pin 2	Red	+12V Power to DCP
Pin 3	Orange	Keyed Power
Pin 4	Gray	Shield
Pin 5	Green	HT Can Low
Pin 6	Yellow	HT Can Hi
Pin 7	Orange	Can1 Hi
Pin 8	Black	Ground from TSD
Pin 9	Black	Ground from DCP
Pin 10	Blue	Can1 Low



### Power/Comm Harness at Hitch

Pin 1	Red	+12V Power to TSD
Pin 2	Red	+12V Power to DCP
Pin 3	Orange	Keyed Power
Pin 4	Gray	Shield
Pin 5	Green	HT Can Low
Pin 6	Yellow	HT Can Hi
Pin 7	Orange	Can1 Hi
Pin 8	Black	Ground from TSD
Pin 9	Black	Ground from DCP
Pin 10	Blue	Can1 Low

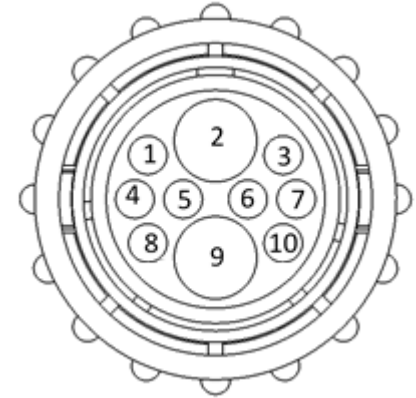

### Bluetooth Receiver Plug on Harness

Pin 1	Red	+12V Power from DCP
Pin 2	Black	Ground from TSD
Pin 3	Yellow	HT Can Low
Pin 4	Gray	Shield
Pin 5	Green	HT Can Hi
Pin 6	Orange	Can1 Hi
Pin 7	Blue	Can1 Low

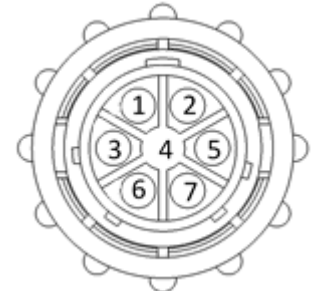

### ISOBUS Plug Baler Side

Pin 1	N/A	
Pin 2	N/A	
Pin 3	120 OHM with Pin 5	
Pin 4	N/A	
Pin 5	120 OHM with Pin 3	
Pin 6	Orange	Can1 Hi
Pin 7	Blue	Can1 Low



### ISOBUS Plug Tractor Side

Pin 1	N/A	
Pin 2	N/A	
Pin 3	+12V Keyed Tractor Power	
Pin 4	N/A	
Pin 5	N/A	
Pin 6	N/A	
Pin 7	N/A	
Pin 8	Orange	Can1 Hi
Pin 9	Blue	Can1 Low

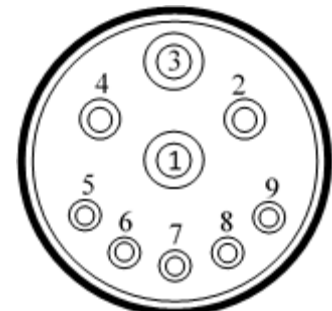

## Pin Outs (continued)

### Main Power Connector on DCP

Pin 1	Red	+12V Power from tractor
Pin 2	Black	Ground from tractor
Pin 3	Orange	Keyed power

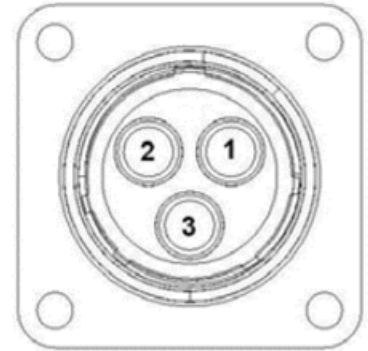

### Star Wheel and Bale Rate Sensor Connector on DCP

Pin 1	Blue	+12V Power
Pin 2	Orange	Ground
Pin 3	Black	Signal for sensor 1
Pin 4	White	Signal for sensor 2
Pin 5	N/A	
Pin 6	N/A	
Pin 7	N/A	
Pin 8	Violet	Star wheel input 1
Pin 9	Brown	Star wheel input 2



### End of Bale Sensor on DCP

Pin 1	Brown	Sensor Power
Pin 2	Blue	Sensor Ground
Pin 3	N/A	
Pin 4	Black	Signal from Sensor

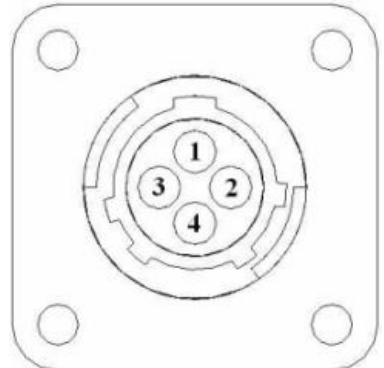

### Pump Communication Plug on DCP

Pin 1	Red	+12V Can
Pin 2	Red	+12V Power
Pin 3	Gray	Shield
Pin 4	Green	Comm Channel OH
Pin 5	Yellow	Comm Channel OL
Pin 6	Blue	Comm Channel IH
Pin 7	Orange	Comm Channel IL
Pin 8	Black	Can Ground
Pin 9	Black	Power Ground
Pin 10	N/A	

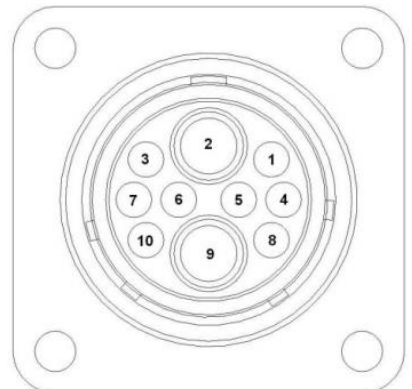

## Pin Outs (continued)

### Pump Connection Colors

Pin 1	Black with Orange Stripe	Pump 1 Ground
Pin 2	Black with Green Stripe	Pump 2 Ground
Pin 3	Black with Yellow Stripe	Pump3 Ground
Pin 4	N/A	
Pin 5	Orange with Black Stripe	Pump 1 Positive
Pin 6	Green with Black Stripe	Pump 2 Positive
Pin 7	Yellow with Black Stripe	Pump 3 Positive

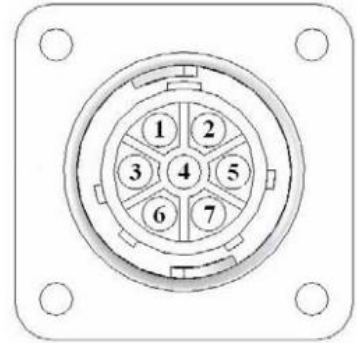

### Flow Meter Connection on Pump Controller

Pin 1	White	+5-12V Power
Pin 2	Green	Ground
Pin 3	Brown	Signal
Pin 4	Black	Shield

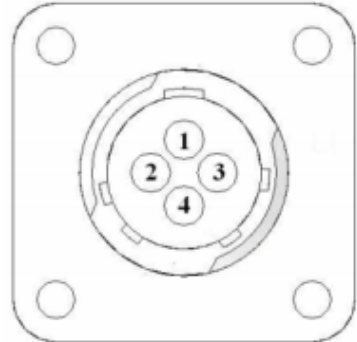

### Connector for Crop Eyes on DCP

Pin 1	Red	+12V Power
Pin 2	Black	Ground
Pin 3	White	Signal
Pin 4	N/A	

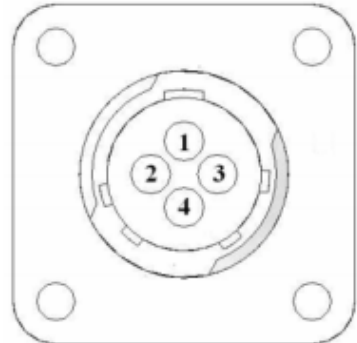

## Common Questions

**1. How do I turn the system on/off?**

Turn the key in the tractor to the ON/OFF position.

**2. How to get in the LBS/TON, MC%, and TONS/HR menus?**

In the **Main Menu** press the **Setup Mode** option. From this screen you can change your application rates and how much product is applied. See the section on **Setting Up For Initial Use** for a detailed explanation of this process.

**3. The unit is stuck in the MC% screen.**

In the MC% screen, level 1 must be less than level 2, and level 2 must be less than level 3. For example, if level 1 is set at 16, level 2 must be set at 17 or higher, and level 3 must be set higher than level 2.

**4. How does Override work?**

Override turns on all three pumps at full output. The pumps will remain at full output until the operator turns these pumps off by pressing the **Override** key again.

**5. The flow meter reading is more or less than the programmed level set in the box.**

Some variation in flow meter readings compared to the programmed set point is normal due to factory tolerances on the pump motors as well as varying tractor voltages inputted to the control box. The flow meter reading is an accurate measure of how much product is actually being applied. The set points then will need to be adjusted if you want to attain a different flow meter reading.

**6. Why don't all the pumps turn on even at higher application rates?**

The selections of what pumps turn on when are automatically controlled by the control box's flow rate look up chart. Thus, not all the pumps turn on at once and the combination of what pumps turn on when is automatically controlled by the software. If you want to make sure all three pumps are working, go to the Diagnostics screen and run pump outputs.

**7. The moisture content displays "LO" or "HI" all the time.**

When the moisture content display does not change frequently while baling, there is likely a faulty star wheel connection. One of the first places to check is inside the white star wheel block. Check to see if the electronic swivel is in the star wheel shaft and check to see that the star wheel shaft is not working out of the block. Also, check moisture disc wheel wires and connectors to see if there is a continuity or grounding problem.

**8. Should the battery connections be removed before jump starting or charging a battery?**

Yes. Anytime the tractor will have voltage going up rapidly the connections should be removed.

**9. How can I turn the optional hay indicators Crop Eyes On/Off from the cab?**

From the **Setup Mode** screen press **Options**. Press the **On/Off** underlined area next to **Crop Eyes**.

**10. What do the lights on the 030-6672B indicate?**

*Blinking Lights* – System is waiting for the processor to connect, which could take up to 35 seconds.

*Red Light* – The Bluetooth receiver has power. *Green Light* – When the proper active connection is selected in the Hay App menu, the green light will indicate connection with the iPad.

## Troubleshooting

<b>PROBLEM</b>	<b>POSSIBLE CAUSE</b>	<b>SOLUTION</b>
Moisture reading errors (high or low)	1. Wire disconnected or bad connection between moisture disc and DCP	1. Reconnect wire.
	2. Low power supply to DCP	2. Check voltage at box. Min of 12V
	3. Wet hay over 60% moisture	
	4. Ground contact with one or both moisture discs and baler mounted processor.	4. Reconnect.
	5. Short in wire between moisture disc and DCP.	5. Replace wire.
	6. Check with hand tester	6. Contact Harvest Tec if no change
Moisture readings erratic.	1. Test bales with hand tester to verify that cab monitor has more variation than hand tester.	
	2. Check all wiring connections for corrosion or poor contact.	2. Apply dielectric grease to all connections.
	3. Check power supply at tractor. Voltage should be constant between 12V and 14V	3. Install voltage surge protection on tractors alternator.
Terminal reads under or over power.	1. Verify with multi-meter actual voltage. Voltage range should be between 12-14 volts.	1. Clean connections and make sure applicator is hooked to battery.
Bale rate displays zero.	1. Bale rate timer sensor error 2. Short in cable. 3. Damaged sensor.	1. Check, clean, tighten connections 2. Replace cable, Replace sensor.
Display will not power up.	1. Connection broke between the display and the DCP. 2. Short in display cable.	1. Check, clean, tighten connections 2. Replace cable.
Display is too dark or light	1. Change in temp or light	1. Use the monitors contrast control.
Display is locked up/froze.	1. CAN communication not responding. 2. Broke connection between the display and DCP.	1. Check connections at DCP and Pump controller including the terminating resistors. 2. Check, clean, and tighten connections. 3. Power unit down and restart after steps 1 & 2 are complete.
Display powers up when key is turned and will not go to the Main Menu screen.	1. CAN communication not responding. 2. Broke connection between the display and DCP.	1. Check connections at DCP and Pump controller including the terminating resistors. 2. Check, clean, and tighten connections. 3. Power unit down and restart after steps 1 & 2 are complete.
Display is locked up/froze and pumps continue to run.	1. CAN communication not responding. 2. Broke connection between the display and DCP.	1. Check connections at DCP and Pump controller including the terminating resistors. 2. Check, clean, and tighten connections. 3. Power unit down and restart after steps 1 & 2 are complete.
Display says PAC error	1. The DCP and Pump controller are not communicating. 2. Broke connection between display and DCP or PAC and DCP.	1. Check all connections at DCP and Pump controller including terminating resistors. 2. Check, clean, and tighten.
Can't select moisture / preservative information on baler run screen	DCP not selected in baler software	Select DCP for the moisture option in machine setup.

Warning: HT system type conflicts with machine setup	CNH Baler ECU recognizes that a Harvest Tec system is installed, but system is not configured correctly.	DCP has to be reconfigured. Contact your dealership to send back to Harvest Tec for repair.
Job records are showing as symbols or incorrect values	The job file is corrupted on SD card	Write down all job record information the operator wishes to keep. Update the DCP software to the most current version available on the Harvest Tec website. Delete all existing jobs by selecting all in the download screen and pressing delete. Be sure to start a new job and verify it is saved by checking job details screen.
Obscure Values in auto / manual mode	The job file is corrupted on SD card	DCP needs to be sent to HT for repair
Can't download job records, stuck at "Saving to USB Stick"	One of more jobs are corrupted on SD card. If "saving to USB" is displayed, some jobs have been downloaded correctly.	DCP needs to be sent to HT for repair
Can't download job records, stuck at "Searching"	If searching is displayed then the first job is corrupted and download will not work.	DCP needs to be sent to HT for repair
No green baler sensors button in bale rate setup screen	DCP is not configured to communicate with baler	If baler is compatible, Harvest Tec can reconfigure DCP to correct setting. Contact your dealership to send back to Harvest Tec for repair.
"Cannot open USB" message when trying to download	DCP does not see a USB stick in the Data Transfer port	Make sure the operator has the USB in the DCP with good connect and not the VT port in the cab of the tractor.
Bluetooth Receiver lights will not illuminate	<ol style="list-style-type: none"> <li>1. Bluetooth receiver not connected</li> <li>2. Harness disconnected</li> <li>3. Low power</li> </ol>	<ol style="list-style-type: none"> <li>1. Check connections and voltage. Minimum 12.5V needed.</li> </ol>
	<p><i>Blinking Lights</i> – System is waiting for the processor to connect, which could take up to 35 seconds.</p> <p><i>Red Light</i> – The Bluetooth receiver has power</p> <p><i>Green Light</i> – When the proper active connection is selected in the Hay App menu, the green light will indicate connection with the iPad.</p>	

## Status Alerts

Two Status Alerts will appear on the Auto and Manual mode screens when the Job Records are approaching, or full of records.

Status Alert "**Bale Records: Less than 1K remaining**". The system is now approaching the maximum amount of records that can be saved. When this code appears download and delete jobs in the Job Records menu. Follow the instructions in Job Records to accomplish this.

Status Alert "**Bale Records failed – Memory Full**". The system will not accept any new data until jobs in the Job Records menu are downloaded and deleted. Follow the instructions in Job Records to accomplish this.

## iPad Troubleshooting

<u>iPad Symptom</u>	<u>Troubleshooting</u>
iPad won't turn on	-Turn your iPad off and on. Press and hold the Sleep/Wake button for a few seconds until a red slider appears; then slide it. Press and hold the Sleep/Wake button to turn on again.
	-Reset your iPad. Press the "Sleep/Wake" button and the "Home" button simultaneously for at least 10 seconds until the Apple logo appears on the screen. This reset will not damage your files.
	-Battery may be drained. Plug iPad into your computer or AC adapter and see if anything happens. The iPad will recognize it has been connected to a power source and charge its battery. If it will no longer charge, the battery must be swapped with a replacement battery. Battery level displays in top right corner of iPad.
<b>Cannot get an active baler connection</b>	-Make sure that your Bluetooth accessory and iOS device are close to each other when connecting.
	-Make sure that your Bluetooth accessory is on and fully charged or connected to power. If it uses batteries, test them to see if they need to be replaced.
	-Restart your Bluetooth receiver, by removing power and reconnecting after 30 seconds.
	-Make sure that you have at least a 3 <sup>rd</sup> generation iPad with iOS8 or greater operating system on your iPad
	-On your iPad, go to Settings > Bluetooth and make sure that Bluetooth is on. If you can't turn Bluetooth on or you see a spinning gear, restart your iPad
	-Unpair the Bluetooth accessory, put the accessory back in discovery mode, then pair and connect it again. By tapping on its name in the Bluetooth accessories tab and then Forget this Device. In settings, tap on a device's name, then Unpair.
	-Display connector plug and bale rate sensors plug are switched on BMP. Switch connections.
	-Short in display cable. Replace the cable.
<b>iPad touchscreen is slow or does not respond</b>	-Screen may be dirty. Clean screen. Unplug everything, turn off iPad and with soft, lint-free, slightly damp cloth gently wipe screen. Do NOT use window cleaners and paper towels.
	-If you have a screen protector sheet, try removing it.
<b>iPad is not charging or is slow to charge</b>	-In order to charge your iPad you can try either connecting your iPad to a power outlet or connecting to a USB 2.0 port on a computer. However, note that computers generally don't supply enough power to their USB ports to be able to charge an iPad. When this happens, a "Not Charging" message will appear.
<b>How can I unlock my iPad if I forgot the passcode</b>	-If you cannot remember the passcode, you will need to <i>restore your device using the computer with which you last synced</i> . This allows you to reset your passcode and resync the data from the device (or restore from a backup). If you restore on a different computer that was never synced with the device, you will be able to unlock the device for use and remove the passcode, but <i>your data will not be present</i> .
<b>How do I send in my iPad for service?</b>	-Refer to your iPad owner's manual or contact Apple. <b>DO NOT SEND iPad TO HARVEST TEC.</b>
<b>For other issues refer to your iPad Owner's Manual or contact Apple Directly</b>	

**\*Harvest Tec Does Not Service iPads\***



## Maintenance

- If you are unsure how to perform any of the maintenance steps have your local authorized dealer perform the tasks.

## Maintenance Schedule

	Daily	10 hrs	400 hrs	Weekly	Monthly	Season
Diagnostics	X					X
Filter bowl cleaning		X				X
Tips & tip screen cleaning		X				X
Tank lid cleaning		X				X
Dielectric grease connections					X	X
Rebuild pumps			X			
Battery connections				X		X
Check valves			X			
Visually inspect hoses				X		X

**Diagnostics:** Follow the instructions in this manual to run the Diagnostics mode.

**Filter bowl cleaning:** The filter bowl is located in front of the applicators tank and is connected to the ball valve. Before cleaning the filter bowl all personal protective equipment must be worn (Face shield or goggles, chemically resistant apron, boots, and gloves).

Verify that the ball valve located next to the pump is turned off. Locate the filter bowl on the side of the pump manifold (A). Unscrew the bottom section of the filter bowl and remove the strainer (B). Clean off any debris and soak in warm water with a mild soap if necessary. Once the screen is clean reinstall by following the directions in reverse.

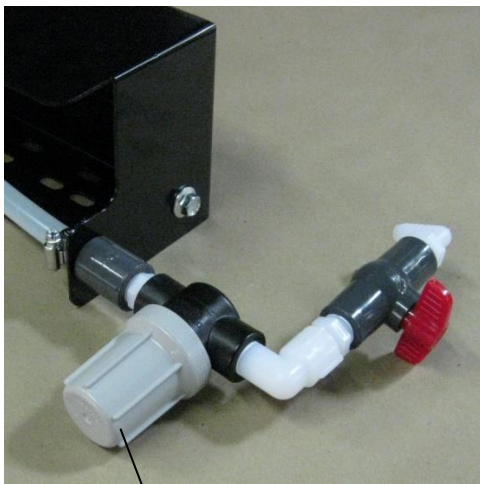

A

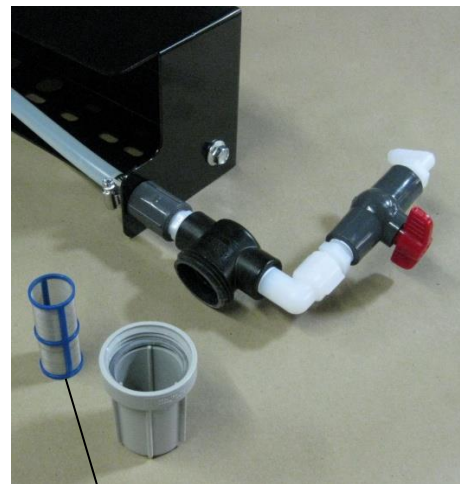

B

**647 & 649 Tips & tip screen cleaning:** The spray shield assembly or nozzle tubes that hold the tips and tip screens is located above the pickup head.

Before cleaning the tips and screens all personal protective equipment must be worn (Face shield or goggles, chemically resistant apron, boots, and gloves).

**For spray shield assemblies only:**

Verify that the ball valve located next to the pumps turned off. Disconnect spray shield from hangers by removing the lynch pins (A). Disconnect check valve nuts and remove hoses from shield (B). Remove shield from baler. Remove all six nozzle caps with a 7/8" wrench (C). Hold the nozzle body from turning while removing the nozzle caps with a 11/16" wrench. Remove the tip, and screen. Clean off any debris and soak in warm water with a mild soap if necessary. Once the tips and screens are cleaned reinstall by following the directions in reverse.

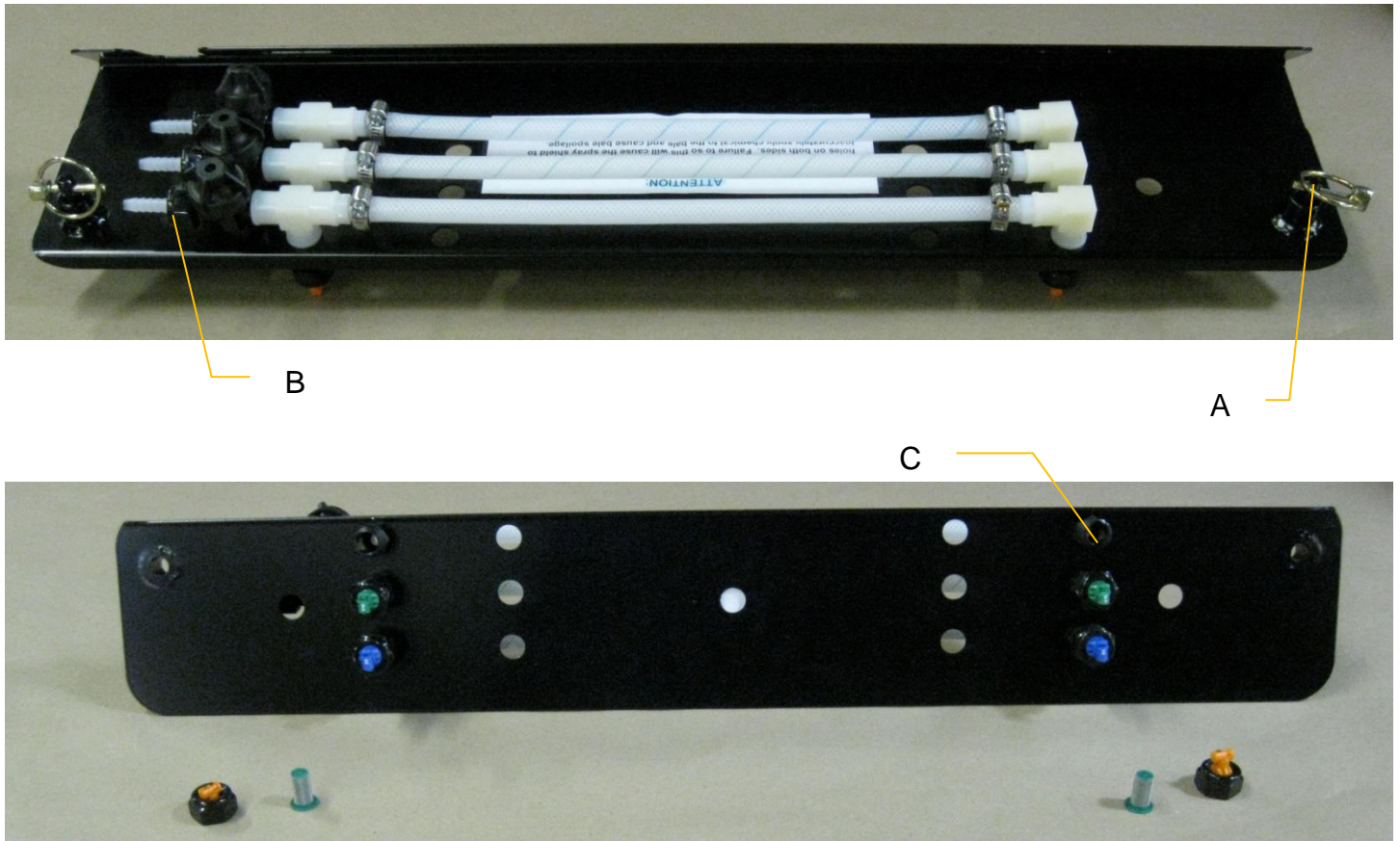

**647C Tips and Tip Screen Cleaning:** The spray shield assembly that holds the tips is located above the pickup head. Before cleaning the tips and screens all personal protective equipment must be worn (Face shield or goggles, chemically resistant apron, boots, and gloves).

Verify that the ball valve located next to the pumps turned off. Disconnect spray shield from hangers by removing the lynch pins or remove tips in place. Remove the tip, and screen. Some models may require a wrench to remove. Clean off any debris and soak in warm water with a mild soap if necessary. Once the tips and screens are cleaned reinstall by following the directions in reverse.

## For nozzle tubes only:

Verify that the ball located next to the pumps is turned off. Clean off any loose debris in the area of the tips. Using a 7/8" wrench remove the nozzle caps (A). Remove the tip and screen. Clean any debris off the tip and screen and soak in warm water with a mild soap if necessary. Once the tips and screens are cleaned reinstall by following the directions in reverse. Make sure the tips are aligned correctly before tightening.

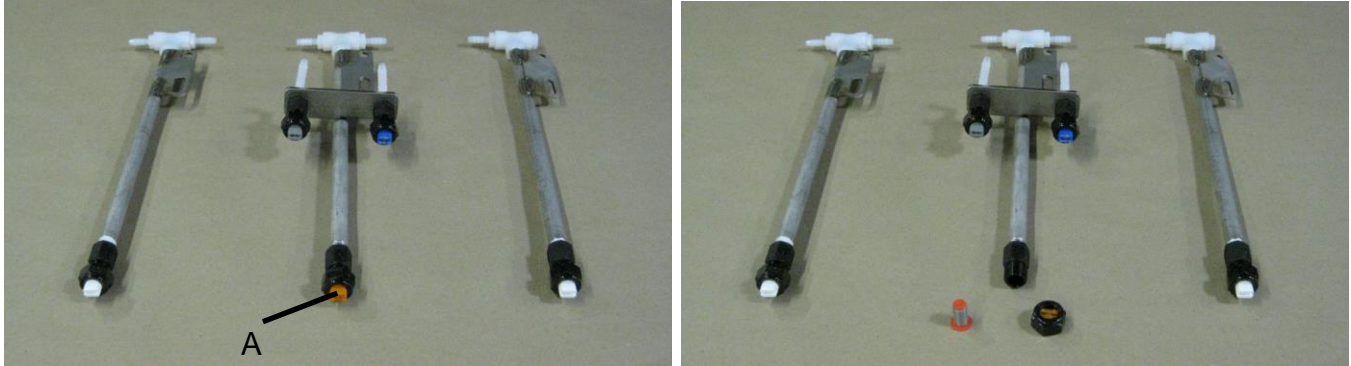

## Miscellaneous maintenance:

1. Depending on the product being used, the system may need to be flushed with water at a regular interval (consult with manufacturer of the chemical). If Harvest Tec product is being used, flushing is not necessary.
2. Although the pump can run dry, extended operation of a dry pump will increase wear. Watch the preservative level in the tank.
3. If you are using bacterial inoculants, flush your system daily after every use.

## Winter Storage

1. Thoroughly flush the system with water.
2. Remove the filter bowl and run dry until the water has cleared out of the intake side.
3. Remove the red plug from the bottom of the pump, drain, and run pump for 30 seconds or until it is dry.
4. Drain all lines on the outlet side.
5. Never use oils or alcohol based anti-freeze in the system.
6. For spring start-up, if the pump is frozen, turn off the power immediately to avoid burning the motor out or blowing a fuse. The pump head can be disassembled and freed or rebuilt in most cases. Check the fuses after the pump has been freed.
7. Disconnect power from the Dual Channel Processor
8. Remove display from tractor and store in a warm, dry place.

## Tank lid cleaning

**Before cleaning the tank lid all personal protective equipment must be worn (Face shield or goggles, chemically resistant apron, boots, and gloves).**

The tank lid is located on the top of the tank. Use the supplied handle on the tank to secure your person and use the other hand to remove any debris from the top of the tank. Unscrew the tank lid and bring down ground level. Use compressed air clean out the tank screen (D). If the screen cannot be thoroughly cleaned with compressed air, replace fitting (005-9022B3). Once the screen is cleaned reinstall the cover.

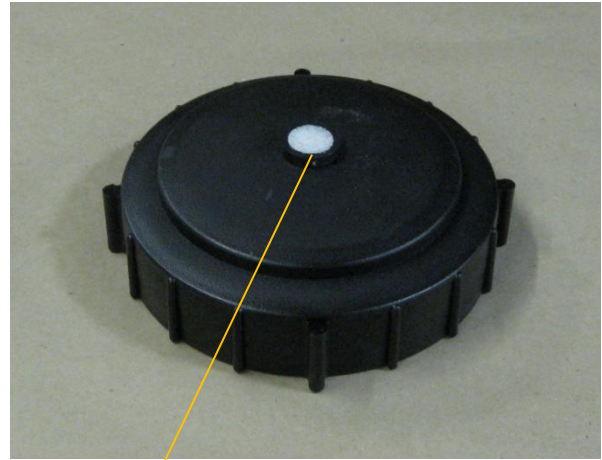
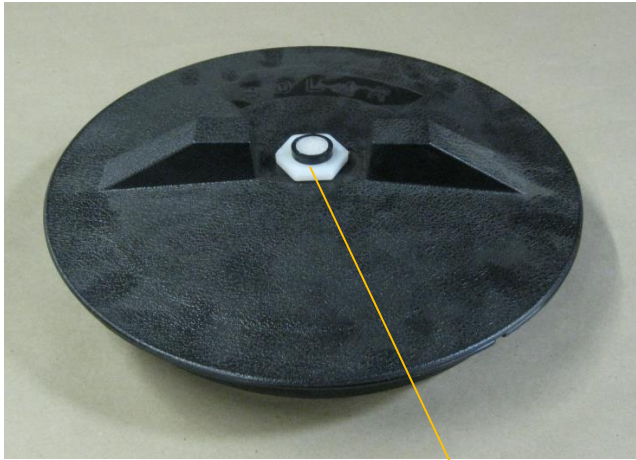

D

**Dielectric grease connections:** Disconnect all harnesses on the applicator, clean the connections, and repack with dielectric grease.

**Rebuild pumps:** If Diagnostic or Manual mode show that the pumps are running lower than normal, a pump rebuild may be necessary. To do this rebuild the pump must be removed from the pump manifold. Pump rebuild is part no. 007-4581. A service pack that includes pump rebuilds and check valves is available from your local dealer.

Verify that the ball valve is turned off. Before working around the pumps all personal protective equipment must be worn (Face shield or goggles, chemically resistant apron, boots, and gloves). Remove pump from manifold. Follow rebuild instructions supplied with pump rebuild kit. Reinstall after rebuild is complete.

**Battery connections:** Follow the batteries safety warnings and clean the battery connections. If the connections cannot be cleaned, replace harness.

**Check Valves:** Before servicing the check valves all personal protective equipment must be worn (Face shield or goggles, chemically resistant apron, boots, and gloves).

Verify the ball valve is turned off before service the check valves. Replace the intake check valves by the pumps (002-4566F) and the discharge check valves by the tip (004-1207VB).



# Parts Breakdown

## Harvest Tec Model 647 Base Kit

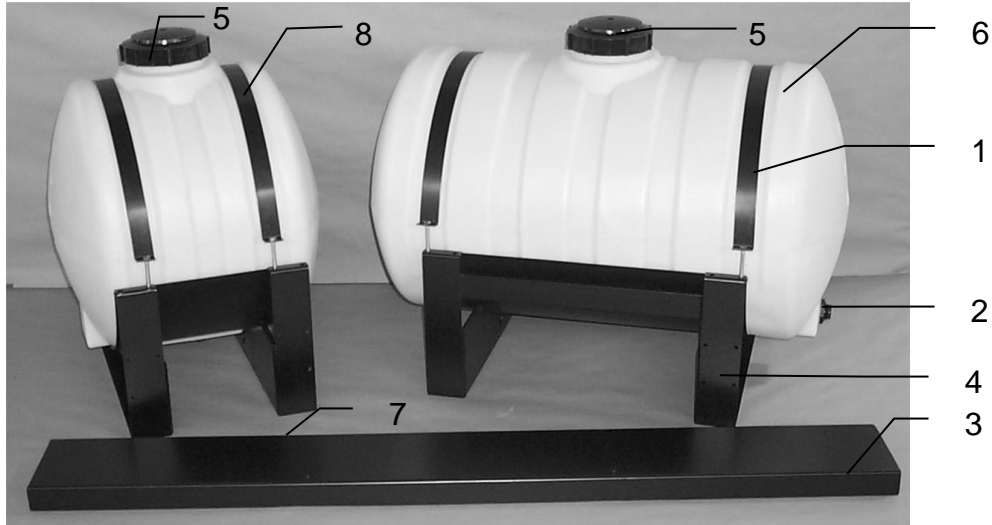

<u>Ref #</u>	<u>Description</u>	<u>Part #</u>	<u>Qty</u>	<u>Ref #</u>	<u>Description</u>	<u>Part #</u>	<u>Qty</u>
1	55 Gallon tank	005-9203	1	5	Tank lid	005-9022C	1
2	Tank fitting	005-9100	1		Tank lid gasket	005-9022CG	1
3	Cross support bracket	001-4445B	1	6	Tank strap	001-4402	1
4	55 Gallon saddle	001-4445A	1	7	25 Gallon saddle	001-4442	1
				8	25 Gallon tank	005-9022	1

## Harvest Tec Model 649 Base Kit

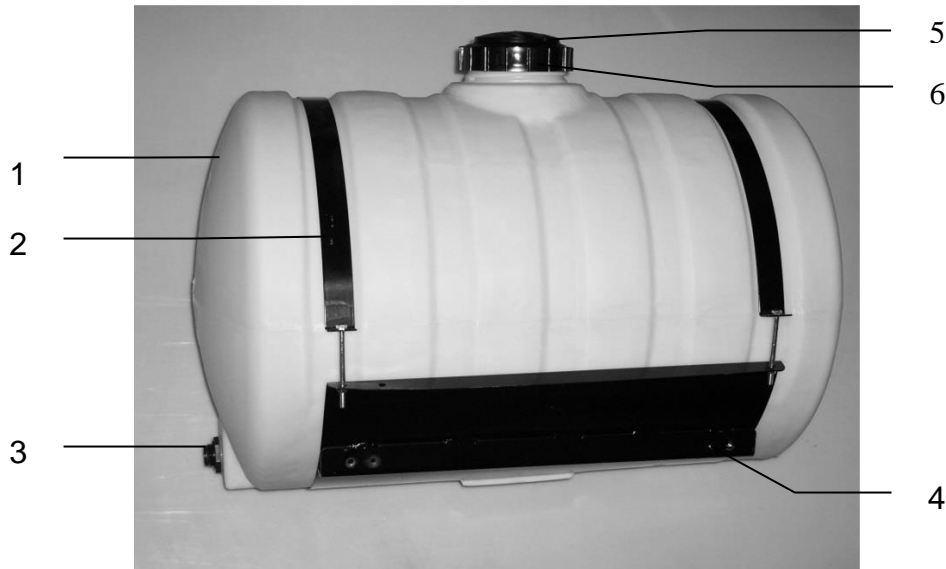

<u>Ref#</u>	<u>Description</u>	<u>Part #</u>	<u>Qty</u>
1	Tank	005-9203	1
2	Straps	001-4402	2
3	Tank Fitting	005-9100	2
4	Saddle	001-4703	1
5	Tank Cap	005-9022C	1
6	Tank Gasket	005-9022CG	1

## Parts Breakdown for the Tank and Saddle Harvest Tec Model 647C Base Kit

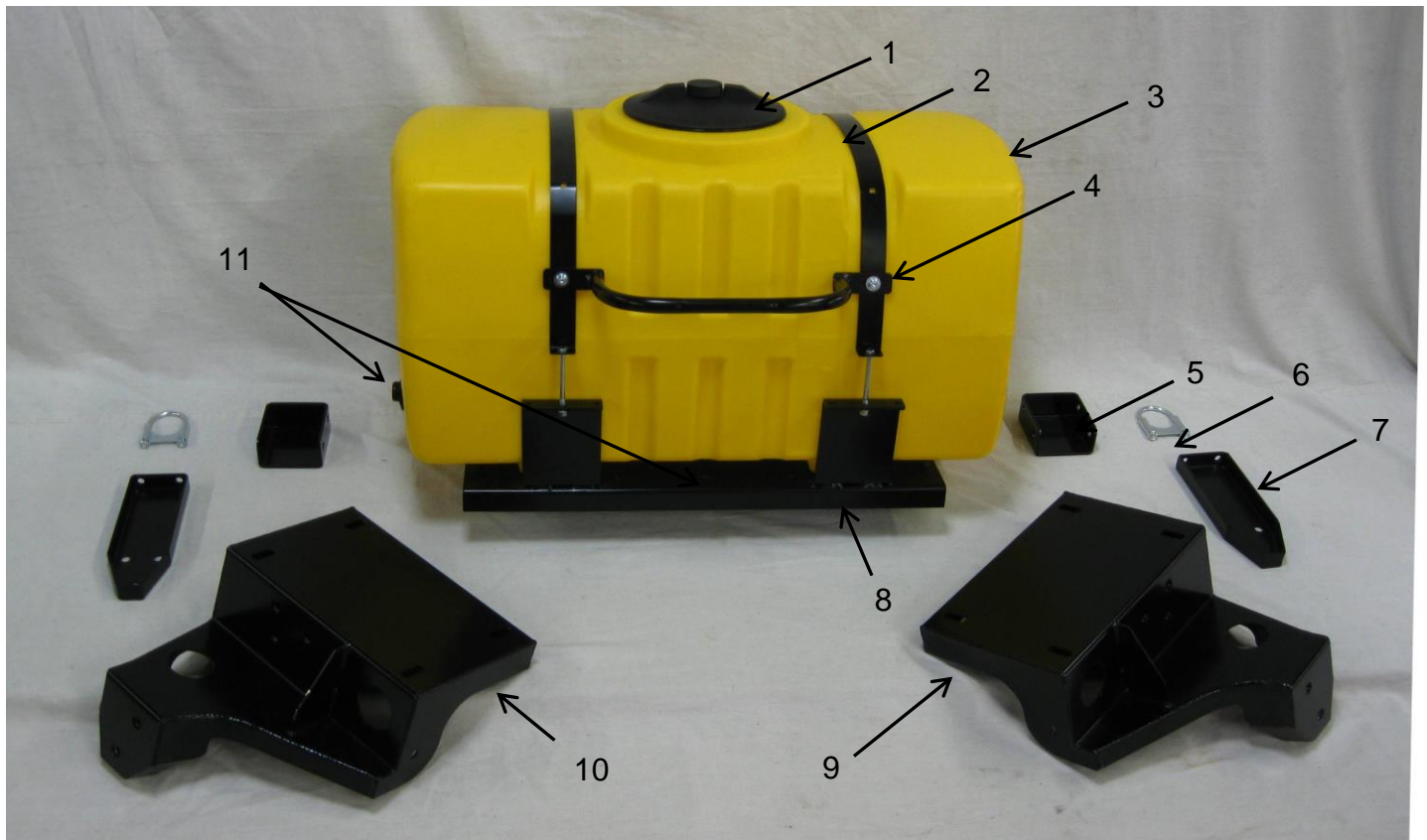

<u>Ref #</u>	<u>Description</u>	<u>Part #</u>	<u>Qty</u>	<u>Ref #</u>	<u>Description</u>	<u>Part #</u>	<u>Qty</u>
1	55 Gallon tank lid	005-9022H	1	7	Anchor Bracket	001-4703XA	2
2	Strap	001-4402	2	8	Saddle	001-4703X	1
3	Tank	005-9203SQ	1	9	Left Leg	001-4703XL	1
4	Handle	001-6707HRS	1	10	Right Leg	001-4703XR	1
5	Anchor Bracket Ext	001-4703XAX	2	11	Tank fitting	005-9100	2
6	U Clamp	001-4703XAB	2				
Tank Kit Assembly						030-0447C-TK	
						(Includes Ref# 1-11)	

## 647, 647C & 649 Parts Breakdown for Drain Fill Kit

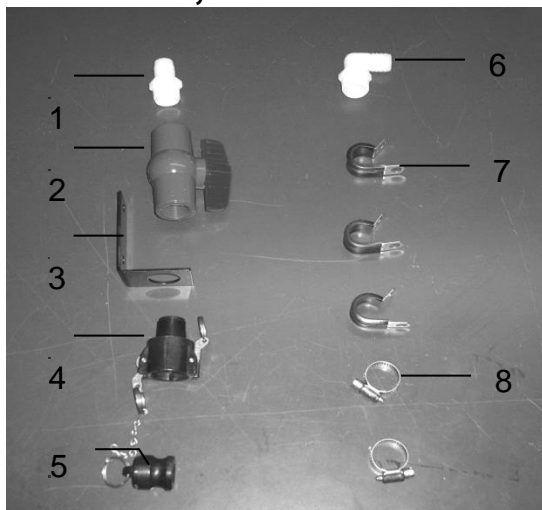

<u>Ref #</u>	<u>Description</u>	<u>Part #</u>	<u>Qty</u>
1	Straight Fitting	003-A3434	1
2	Ball valve	002-2200	1
3	Valve Holder	001-6702H	1
4	Female Coupler	002-2204A	1
5	Male Coupler	002-2205G	1
6	Elbow	003-EL3434	1
7	Jiffy Clip	008-9010	3
8	Hose Clamps	003-9004	2
NP	3/4" Hose	002-9002	8ft

## Parts Breakdown for Pump Manifold

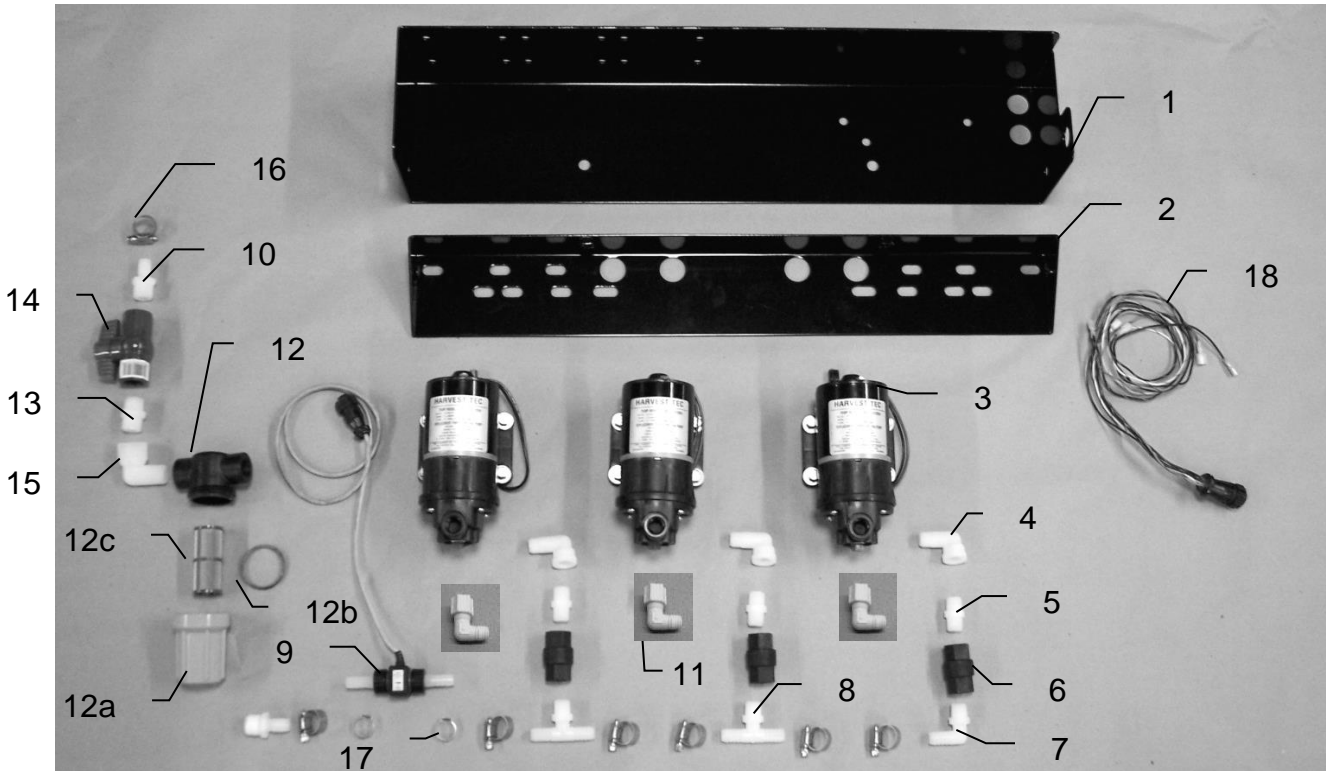

<u>Ref#</u>	<u>Description</u>	<u>Part#</u>	<u>Qty</u>
1	Pump plate	001-4646D	1
2	Mounting Bracket	001-4646C	1
3	Pump	007-4120H	3
4	Street elbow fitting	003-SE38	3
5	Nipple fitting	003-M3838	3
6	Check valve	002-4566F	3
7	Elbow fitting	003-EL3812	1
8	Tee fitting	003-T3812HB	2
9	Flow meter assembly	006-4725A	1
10	Straight fitting	003-A1212	2
11	Elbow fitting	003-JEL1238	3
12	Filter bowl assembly	002-4315-100	1
12a	Filter bowl only	002-4315F	1
12b	Filter bowl gasket	002-4315D	1
12c	Filter bowl screen	002-4315A	1
13	Nipple fitting	003-M1212	1
14	Ball valve	002-2212	1
15	Street elbow fitting	003-SE12	1
16	Hose clamp	003-9003	7
17	Hose clamp (Flow Meter)	003-9005	2
18	Pump Cable	006-4660Z	1
NP	Pump rebuild kit (1 per pump)	007-4581	1
NP	Elbow	003-EL1212	1
NP	Not Pictured		

## 647 & 649 Moisture Pads and Hose Breakdown

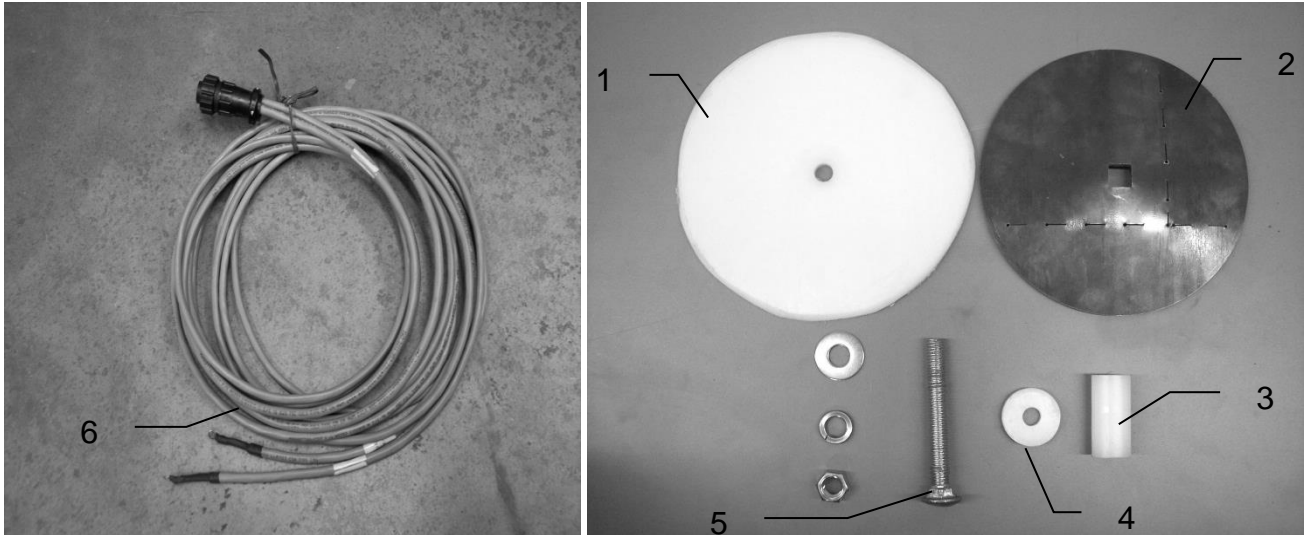

<u>Ref#</u>	<u>Description</u>	<u>Part #</u>	<u>Qty</u>
1	Plastic Pad	006-4641F	2
2	Moisture Disc	006-4641H	2
3	Plastic Bushing	006-4641G	2
4	Plastic Isolator	006-4641I	2
5	4" x 1/2" Bolt	Misc Hardware	2
6	Moisture Cable	006-4640G2	1
1-5	Moisture Pad Assembly	030-4643	2

## 647, 647C & 649 Hose Parts Breakdown

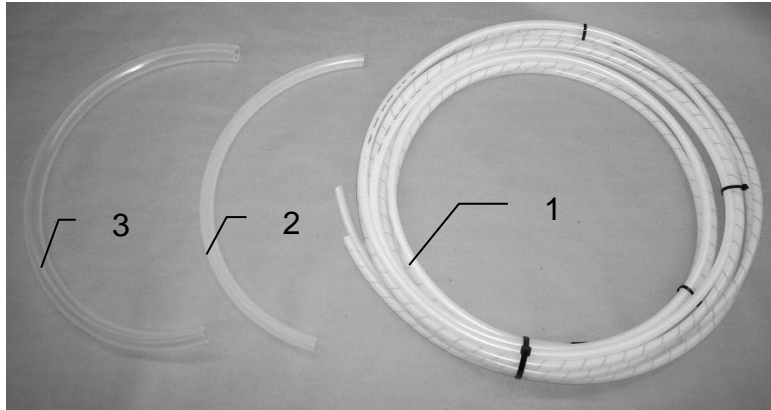

<u>Ref #</u>	<u>Description</u>	<u>Part #</u>	<u>Qty</u>
1	Triple Weld (pumps to tips)	002-9016	15ft
		002-9016B	15ft
		002-9016G	15ft
	Hose assembly	030-9016RB	1
2	1/2" Hose (tank to filter)	002-9001	6ft
3	3/4" Hose Drain Fill Line	002-9002	10ft



## 647C Parts Breakdown for Moisture Sensor Discs

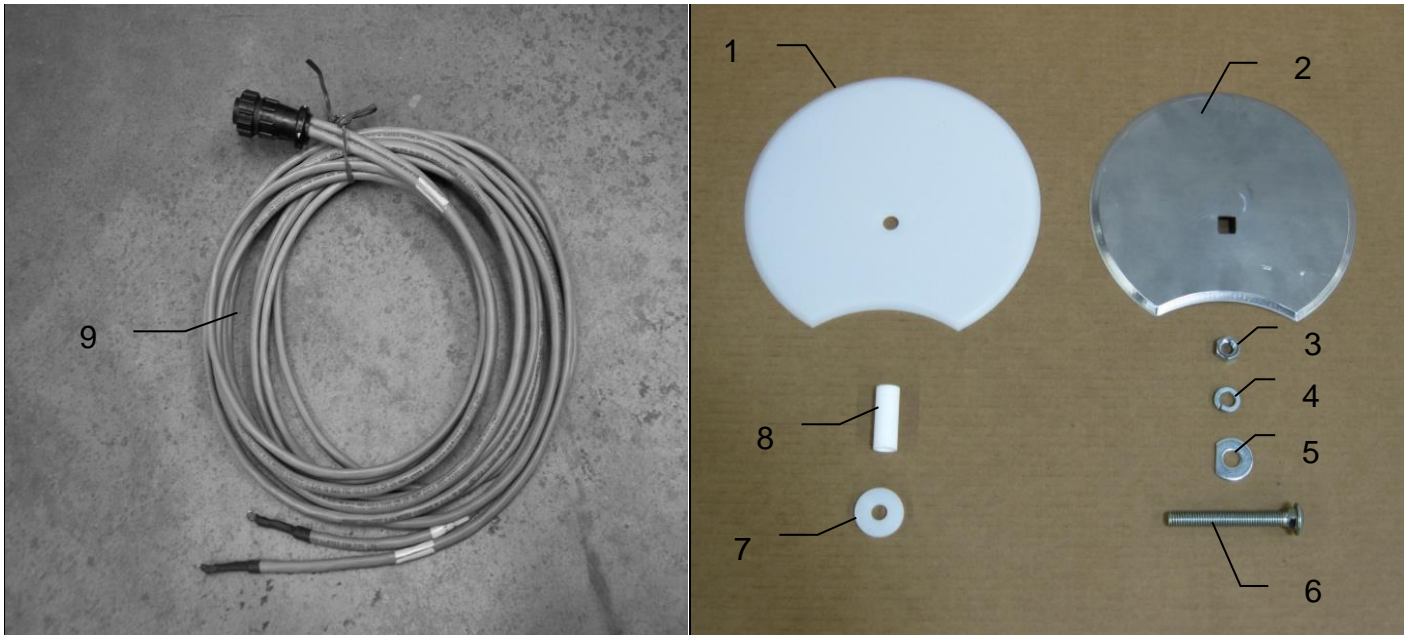

<u>Ref</u>	<u>Description</u>	<u>Part #</u>	<u>Qty</u>
1	CNH RB Moisture Isolator	006-4641FX	2
2	CNH RB Moisture Disk	006-4641HX	2
3	1/2" JAM Nut	Misc Hardware	4
4	1/2" Lock	Misc Hardware	4
5	1/2" D Washer	Misc Hardware	6
6	1/2"x 4" Bolt	Misc Hardware	2
7	Sensor Bushing	006-4641G	2
8	Sensor Isolator	006-4641I	2
9	Moisture Cable	006-4640GX	1
	Moisture Disc Assembly	030-4643C (Includes Ref # 1-8)	

## 647, 647C & 649 Hose Parts Breakdown

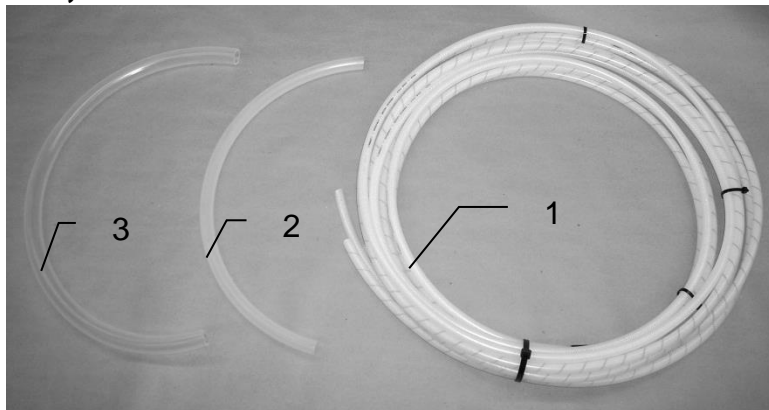

<u>Ref #</u>	<u>Description</u>	<u>Part #</u>	<u>Qty</u>
1	Triple Weld (pumps to tips)	002-9016	15ft
		002-9016B	15ft
		002-9016G	15ft
	Hose assembly	030-9016RB	1
2	1/2" Hose (tank to filter)	002-9001	6ft
3	3/4" Hose Drain Fill Line	002-9002	10ft

## Parts Breakdown for Control Boxes and Wiring Harnesses

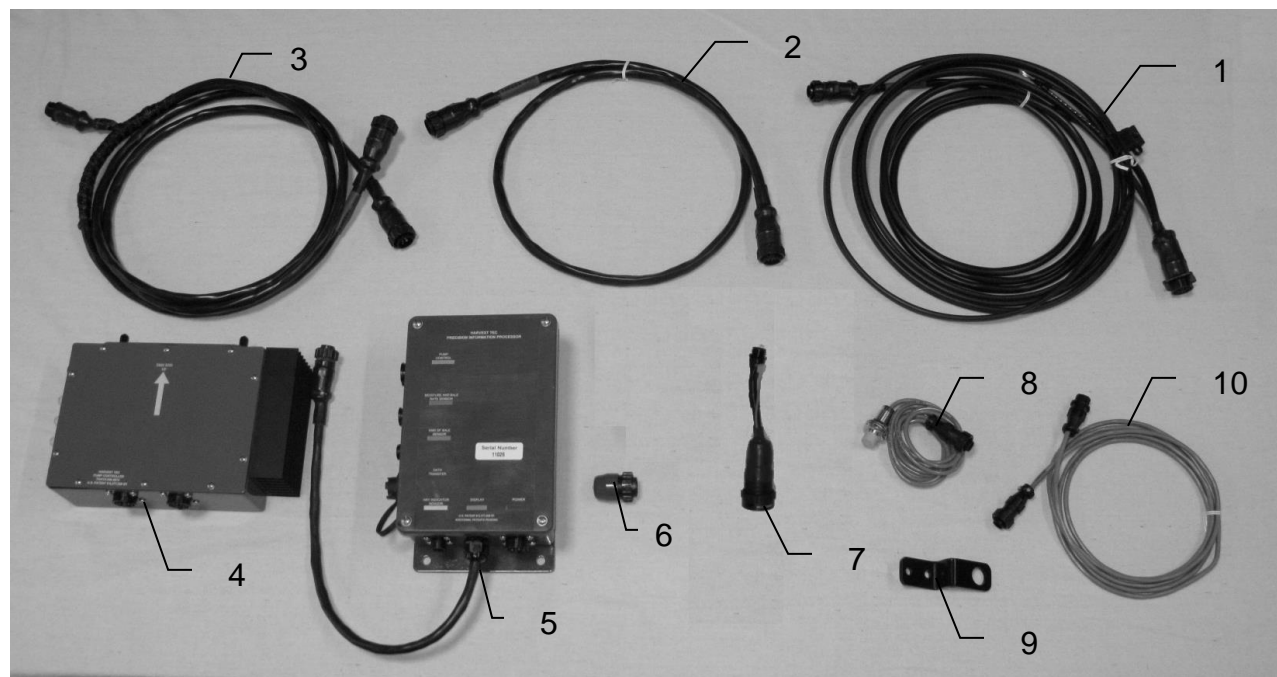

<u>Ref</u>	<u>Description</u>	<u>Part#</u>	<u>Qty</u>
1	Power & communication tractor	006-6650TM	1
2	Pump controller harness	006-5650FC	1
3	Power & communication baler	006-6650LS	1
4	Pump controller	006-5672	1
5	Dual Channel Processor (DCP)	006-6671RB	1
6	Terminating resistor	006-5660Z	1
7	Optional ISOBUS Tractor Plug (not included)	006-6670A	1
8	Bale rate timer	006-7400	1
9	Bale rate timer bracket	001-4648RB	1
10	Bale rate timer sensor extension	006-7400EXT	1
11	Bluetooth Receiver	030-6672B	
NP	Key switch wire	006-5650K	1
NP	Dust plug kit	006-5651PLUGS	1

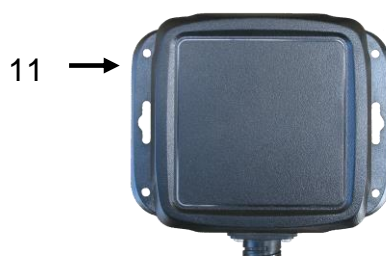

## Optional iPad Mini Mounting Kit (030-2014MK)

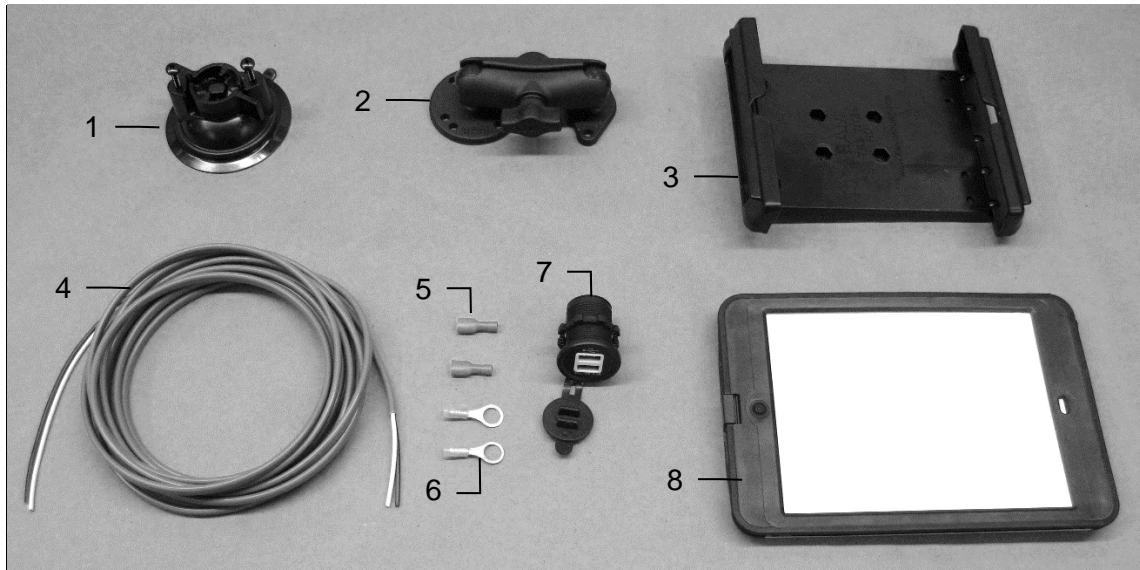

<u>Ref</u>	<u>Description</u>	<u>Part #</u>	<u>Qty</u>
1	Suction cup mount	001-2012SCM	1
2	Ram mount	001-2012H	1
3	iPad Mini spring load cradle (Mini 4)	001-2012SLC	1
4	16 gauge power wire	006-4723P	1
5	Female spade connector	Hardware	2
6	Eye loop connector	Hardware	2
7	iPad Mini Charger 12V	001-2012P	1
8	iPad Mini 4 case	001-2012C4	1
NP	4 amp fuse	Hardware	1
	Mounting Kit Assembly	030-2014MK (Includes All Parts)	

### Installation Instructions

1. Identify 12V power source for wires to connect.
  - a. Eye loops included if wiring directly to the battery is desired.
  - b. Test for key power source if preferred to have power to the USB shut off with the key.
2. Once power source is identified, cut wires to desired length.
3. Crimp the two supplied quick connectors onto each the white and black wire.
4. Remove the round locking plastic nut from USB plug before connecting the wires. Black (+) White (-).
5. The wires will then be hooked to the designated terminals on the bottom of the USB plug
6. Drill a 1 1/8" hole in the preferred mounting location. Be sure to clean any sharp edges after drilling.
7. Feed the wires through the mounting hole.
8. If using the round plastic nut to secure plug in place, slide the nut back over the wiring before connecting the wires to powered source.
9. Connect the wires to the identified power source if easier to do so before tightening the plug into place.
10. Tighten plug using either the round plastic nut or mounting plate and two screws, both options supplied.
11. Once connected, hook a USB charging cord into the plug and connect a mobile device/tablet to ensure the plug is operating as you wish (key power working properly if necessary).

**NOTE: This plug is not designed to charge two iPads. System damage could occur if this is attempted. System will charge a mobile phone and iPad simultaneously without problem.**

## Optional iPad Display Kit (030-4670DK)

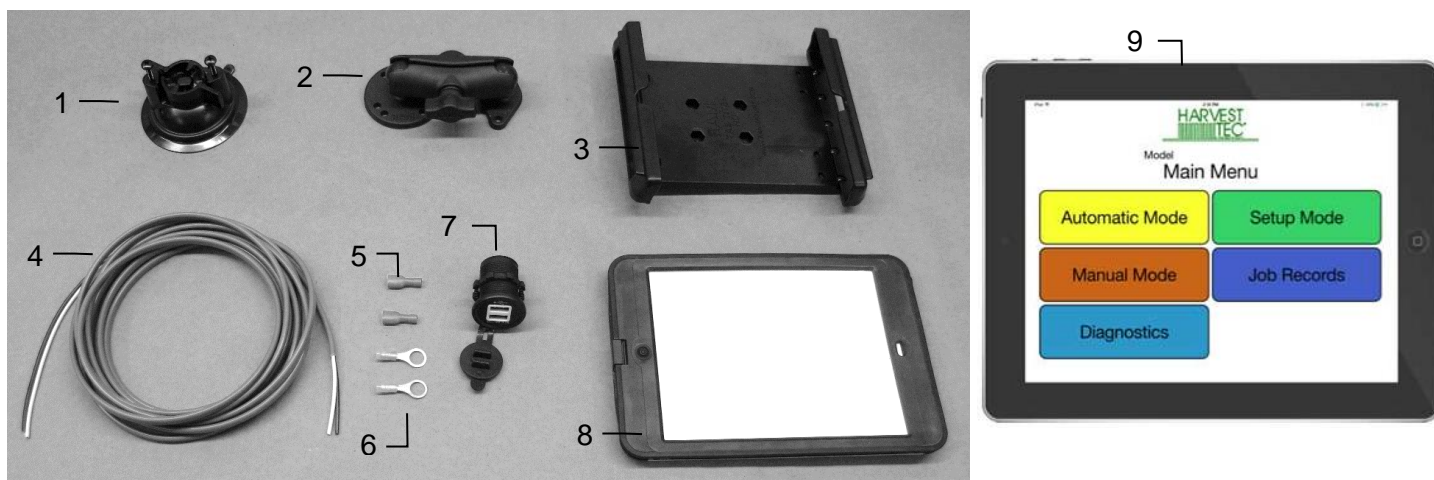

Ref	Description	Part #	Qty	Ref	Description	Part #	Qty
1	Suction cup mount	001-2012SCM	1	7	iPad Mini Charger 12V	001-2012P	1
2	Ram mount	001-2012H	1	8	iPad Mini 4 case	001-2012C4	1
3	iPad Mini spring load cradle (Mini 4)	001-2012SLC	1	9	iPad Mini 4	006-4670IP	1
4	16 gauge power wire	006-4723P	1	NP	4 amp fuse	Hardware	1
5	Female spade connector	Hardware	2				
6	Eye loop connector	Hardware	2				
					Mounting Kit Assembly	030-4670DK (Includes All Parts)	

### Installation Instructions

1. Identify 12V power source for wires to connect.
  - a. Eye loops included if wiring directly to the battery is desired.
  - b. Test for key power source if preferred to have power to the USB shut off with the key.
2. Once power source is identified, cut wires to desired length.
3. Crimp the two supplied quick connectors onto the white and black wire.
4. Remove the round locking plastic nut from USB plug before connecting the wires. Black (+) White (-).
5. The wires will then be hooked to the designated terminals on the bottom of the USB plug
6. Drill a 1 1/8" hole in the preferred mounting location. Be sure to clean any sharp edges after drilling.
7. Feed the wires through the mounting hole.
8. If using the round plastic nut to secure plug in place, slide the nut back over the wiring before connecting the wires to powered source.
9. Connect the wires to the identified power source if easier to do so before tightening the plug into place.
10. Tighten plug using either the round plastic nut or mounting plate and two screws, both options supplied.
11. Once connected, hook a USB charging cord into the plug and connect a mobile device/tablet to ensure the plug is operating as you wish (key power working properly if necessary).

**NOTE: This plug is not designed to charge two iPads. System damage could occur if this is attempted. System will charge a mobile phone and iPad simultaneously without problem.**



# Harvest Tec Model 447-SO Installation Kit

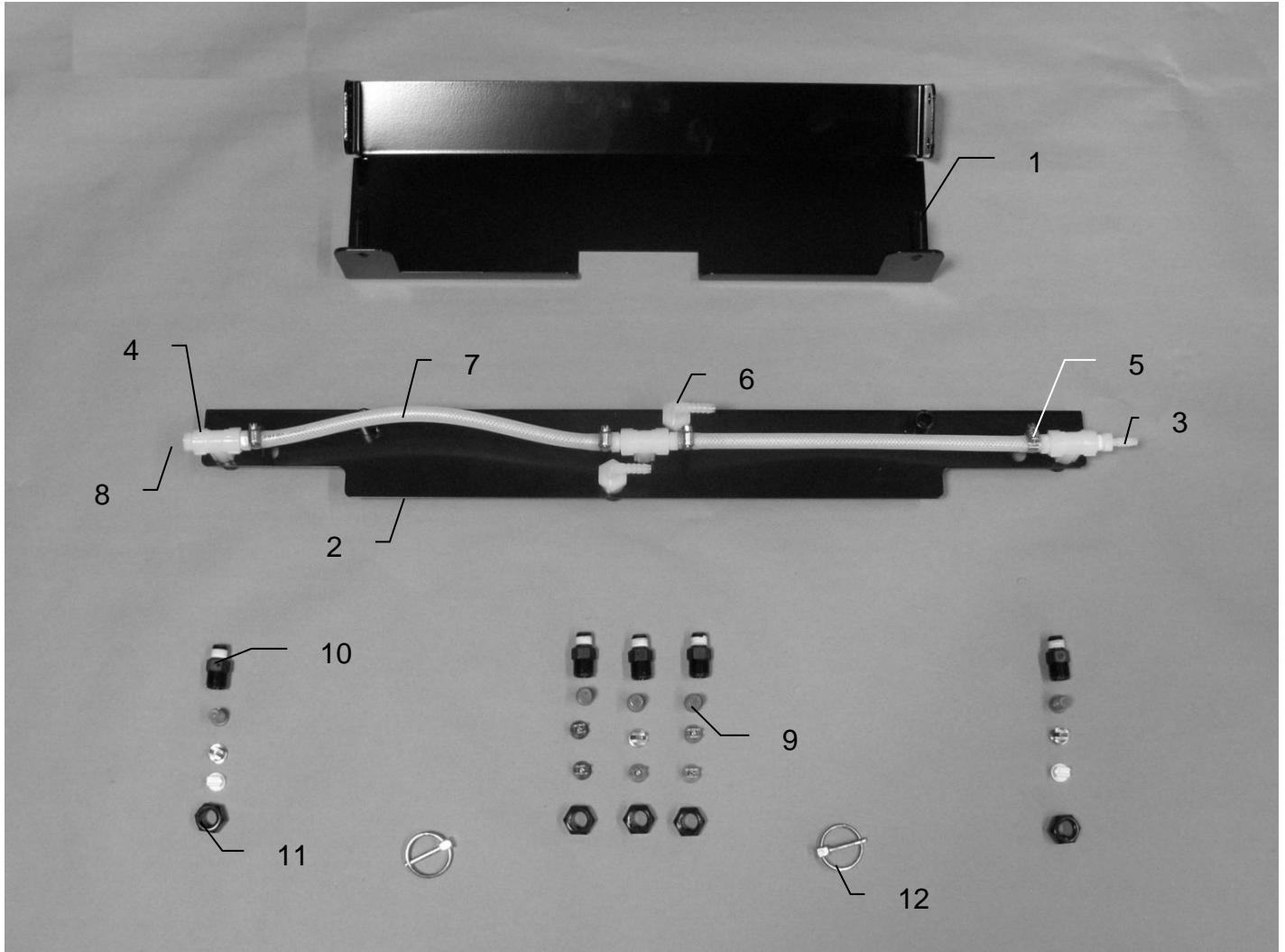

<u>Ref</u>	<u>Description</u>	<u>Part #</u>	<u>Qty</u>	<u>Ref</u>	<u>Description</u>	<u>Part#</u>	<u>Qty</u>
1	Shield bracket	001-4810BRH	1	NP	Tip – Low (silver)	004-650033-SS	3
2	Spray shield	001-4810B	1	NP	Tip – Low (green)	004-XR110015VS	1
3	Straight fitting	003-A1414	5	NP	Tip – Low (red)	004-XR11004VS	1
4	Tee	003-TT14	3	NP	Tip – High (white)	004-650050-PT	2
5	Hose clamp	003-9002	7	NP	Tip – High (orange)	004-XR11001VS	1
6	Elbow	003-EL1414F	2	NP	Tip – High (blue)	004-XR11003VS	1
7	Hose	002-9016	3ft	NP	Tip – High (grey)	004-XR11006VS	1
8	Plug	003-F14	1				
9	Tip strainer	004-4213-200	5	NP	Not Pictured		
10	Nozzle body	004-4722	5				
11	Nozzle cap	004-4723	5				
12	Lynch pin	008-4576	2				

# Harvest Tec Model 647C Installation Kit

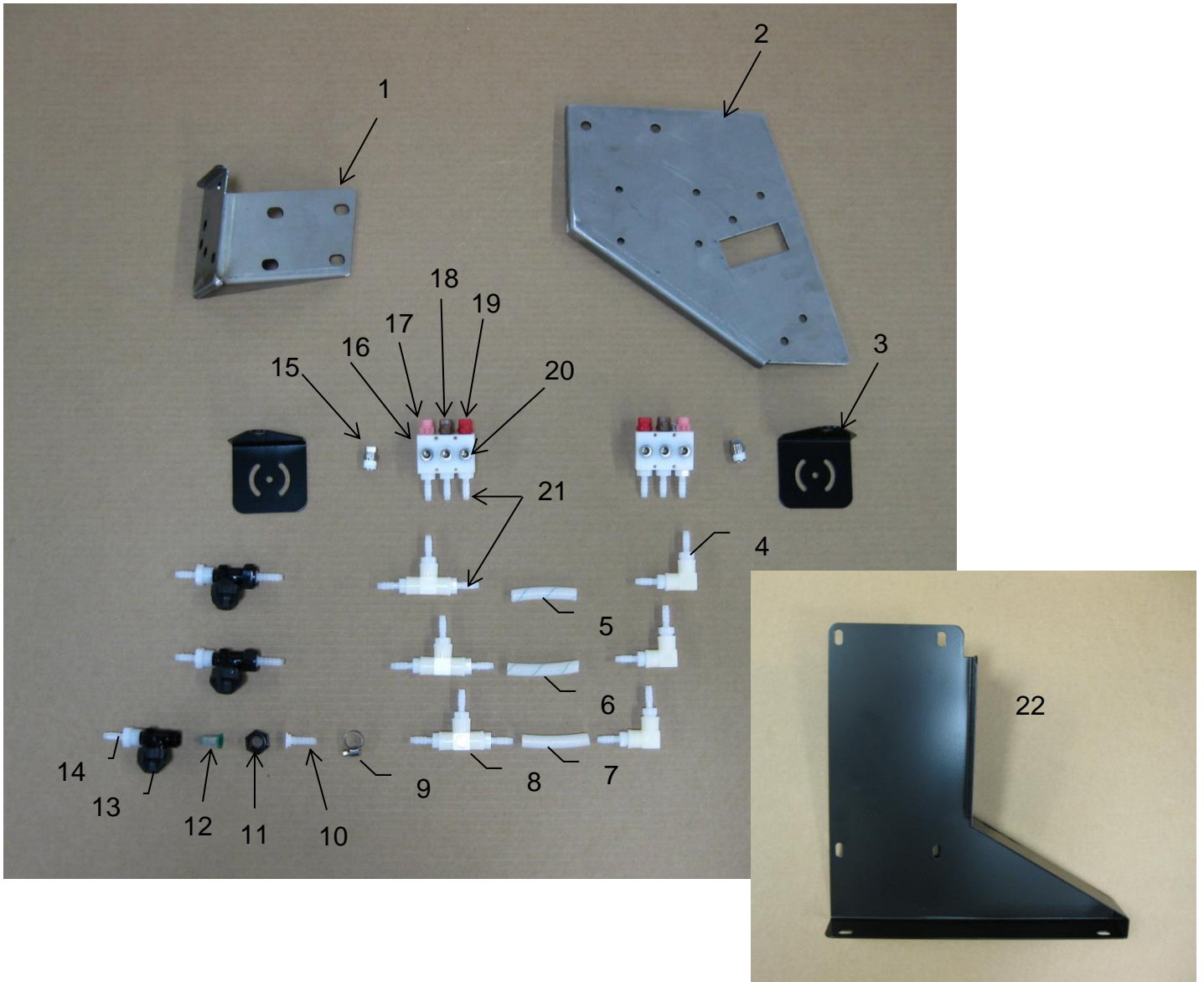

<u>Ref</u>	<u>Description</u>	<u>Part #</u>	<u>Qty</u>	<u>Ref</u>	<u>Description</u>	<u>Part#</u>	<u>Qty</u>
1	Pump Plate Bracket	001-4703XF	1	15	Tip –Stainless	004-T800067-SS	2
2	Pump/Valve Mount	001-4703XE	1	16	Spray Shield Manifold	001-4435NSB	2
3	Spray Block Holder	001-4703XD	2	17	Tip (pink)	004-T8001-PT	2
4	Elbow	003-SE14F	3	18	Tip (brown)	004-T80015-PT	2
5	Hose-clear	002-9016	6ft	19	Tip (red)	004-T8003-PT	2
6	Hose-green striped	002-9016G	6ft	20	Plug Allen SS	003-F14A	6
7	Hose-blue striped	002-9016B	6ft	21	Fitting	003-A1414	21
8	Tee	003-TT14SQ	3				
9	Hose Clamp	003-9002	27	22	Comm RB Bracket 600 Series	001-4703XG	1
10	Fitting	003-A1414VB	3				
11	Nozzle cap	004-4723	3				
12	Tip Strainer	004-1203-100	3				
13	Check Valve	004-1207VB	3				
14	Fitting	003-A1414F	3				
					Shield Only Assembly	030-0447C-SO (Includes Ref # 3-21)	

## Harvest Tec Model 4503B Installation Kit

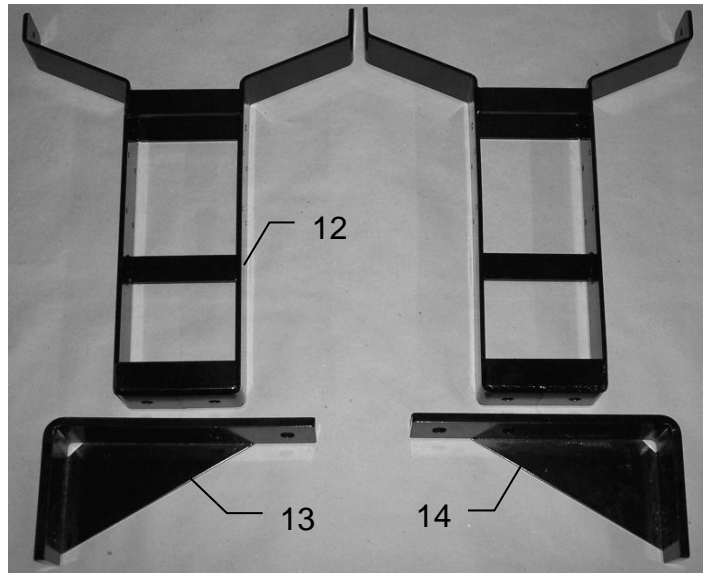
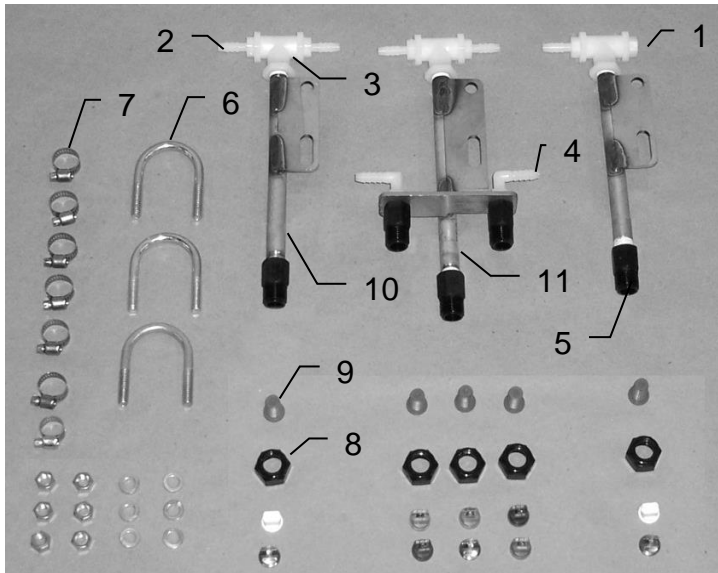

<u>Ref</u>	<u>Description</u>	<u>Part#</u>	<u>Qty</u>	<u>Description</u>	<u>Part#</u>	<u>Qty</u>
1	Plug	003-F14	1	Tip – Low (silver)	004-650033-SS	3
2	Straight fitting	003-A1414	5	Tip – Low (green)	004-XR110015VS	1
3	Tee	003-TT14	3	Tip – Low (red)	004-XR11004VS	1
4	Elbow	003-EL1414	2	Tip – High (white)	004-650050-PT	2
5	Nozzle body	004-4721	5	Tip – High (orange)	004-XR11001VS	1
6	U bolt	001-4714UBS	3	Tip – High (blue)	004-XR11003VS	1
7	Hose clamp	003-9002	7	Tip – High (grey)	004-XR11006VS	1
8	Nozzle cap	004-4723	5			
9	Strainer w/ check	004-4213-200	5			
10	Nozzle tube	001-4714P	2			
11	Nozzle tube auto	001-4714AP	1			
12	Saddle legs	001-4703B	2			
13	Left mtg bracket	001-4703EL	1			
14	Right mtg bracket	001-4703ER	1			
NP	DCP mount	001-4703BPM	2			
NP	45 degree elbow	003-SE4514	5			
NP	Jack extension	001-4703EXT	1			

## Harvest Tec Model 4504B Installation Kit

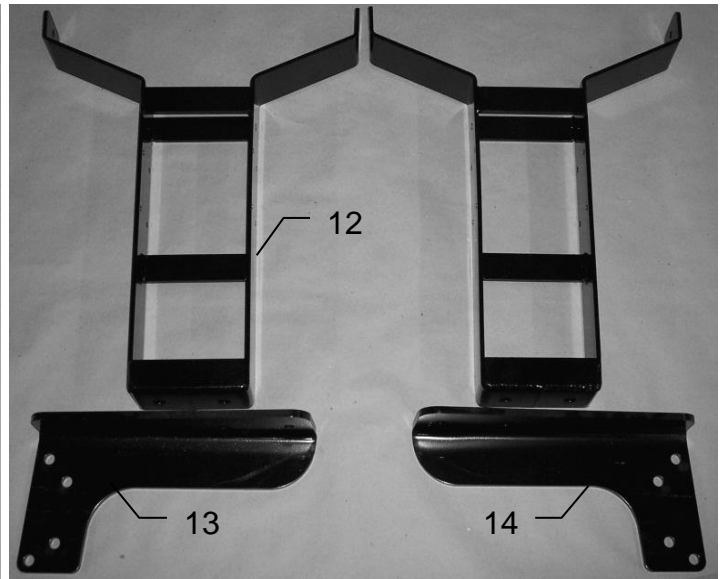
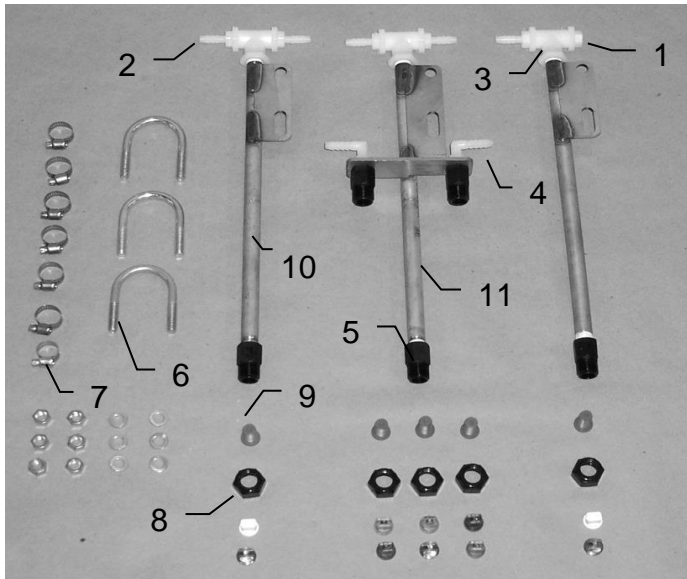

<u>Ref</u>	<u>Description</u>	<u>Part#</u>	<u>Qty</u>	<u>Description</u>	<u>Part#</u>	<u>Qty</u>
1	Plug	003-F14	1	Tip – Low (silver)	004-650033-SS	3
2	Straight fitting	003-A1414	5	Tip – Low (green)	004-XR110015VS	1
3	Tee	003-TT14	3	Tip – Low (red)	004-XR11004VS	1
4	Elbow	003-EL1414	2	Tip – High (white)	004-650050-PT	2
5	Nozzle body	004-4721	5	Tip – High (orange)	004-XR11001VS	1
6	U bolt	001-4714UBS	3	Tip – High (blue)	004-XR11003VS	1
7	Hose clamp	003-9002	7	Tip – High (grey)	004-XR11006VS	1
8	Nozzle cap	004-4723	5			
9	Tip strainer with check	004-4213-200	5			
10	Nozzle tube	001-4714	2			
11	Nozzle tube auto	001-4714A	1			
12	Saddle leg	001-4703B	2			
13	Left mtg bracket	001-4703DL	1			
14	Right mtg bracket	001-4703DR	1			
NP	DCP mount	001-4703BPM	2			



## Harvest Tec Model 4505B Installation Kit

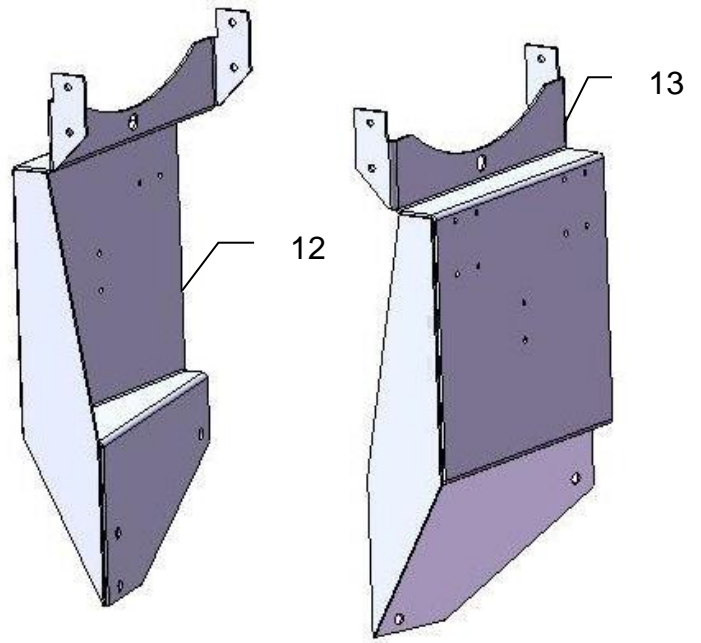
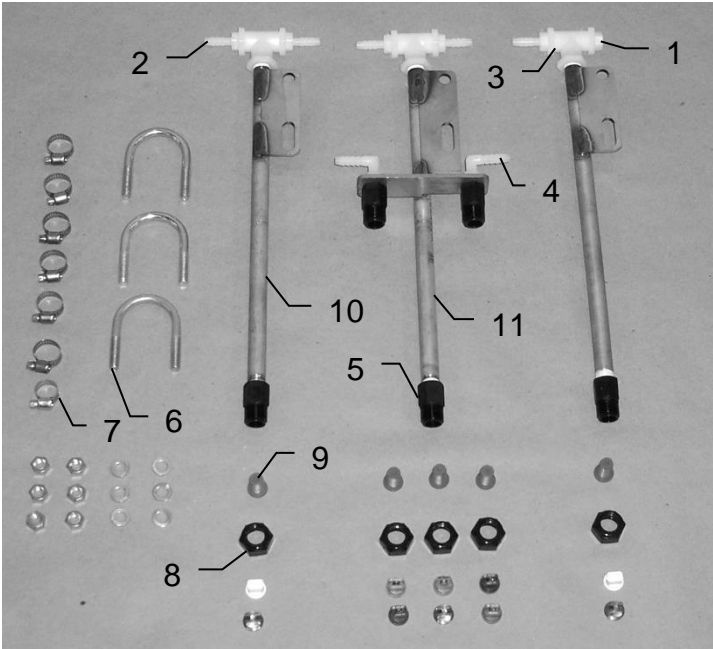

<u>Ref</u>	<u>Description</u>	<u>Part#</u>	<u>Qty</u>	<u>Description</u>	<u>Part#</u>	<u>Qty</u>
1	Plug	003-F14	1	Tip – Low (silver)	004-650033-SS	3
2	Straight fitting	003-A1414	5	Tip – Low (green)	004-XR110015VS	1
3	Tee	003-TT14	3	Tip – Low (red)	004-XR11004VS	1
4	Elbow	003-EL1414	2	Tip – High (white)	004-650050-PT	2
5	Nozzle body	004-4721	5	Tip – High (orange)	004-XR11001VS	1
6	U bolt	001-4714UBS	3	Tip – High (blue)	004-XR11003VS	1
7	Hose clamp	003-9002	7	Tip – High (grey)	004-XR11006VS	1
8	Nozzle cap	004-4723	5			
9	Tip strainer w/check	004-4213-200	5			
10	Nozzle tube	001-4714	2			
11	Nozzle tube auto	001-4714A	1			
12	Left saddle leg	001-4703FL	1			
13	Right saddle leg	001-4703FR	1			

## Harvest Tec Model 4508B Installation Kit

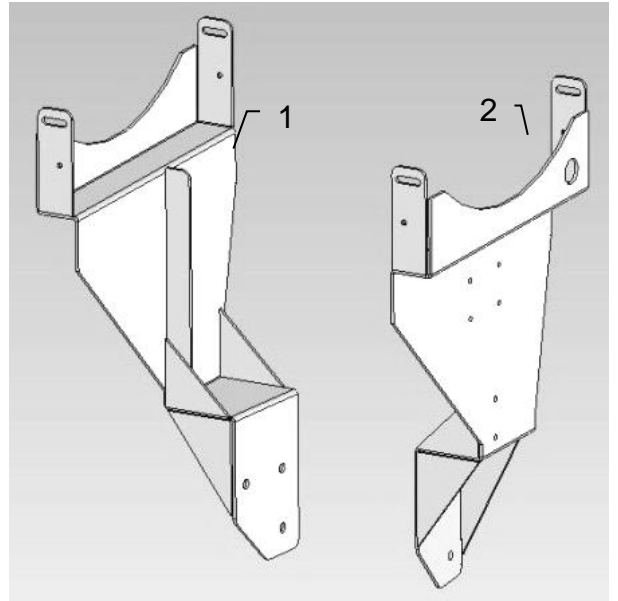
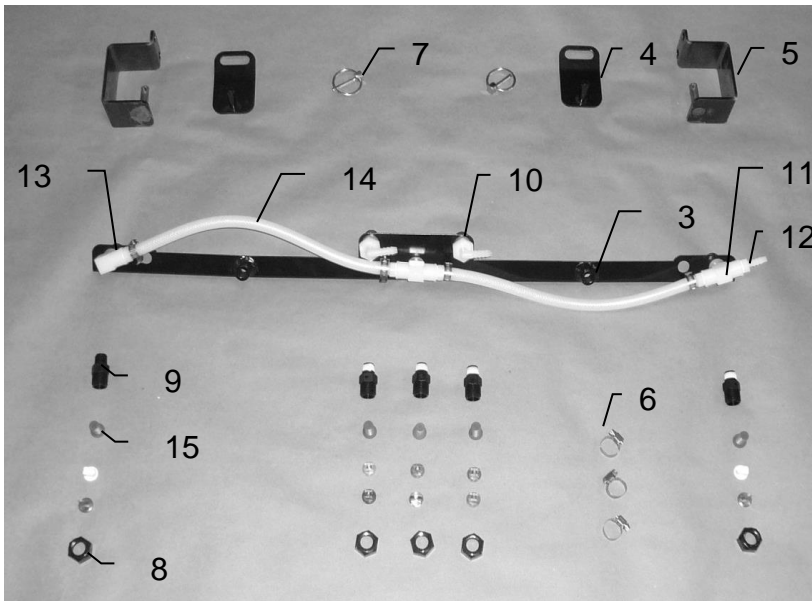

<u>Ref</u>	<u>Description</u>	<u>Part#</u>	<u>Qty</u>	<u>Description</u>	<u>Part#</u>	<u>Qty</u>
1	Left leg	001-4703L	1	Tip – Low (silver)	004-650033-SS	3
2	Right leg	001-4703K	1	Tip – Low (green)	004-XR110015VS	1
3	Spray shield	001-4703GR	1	Tip – Low (red)	004-XR11004VS	1
4	Shield Holder	001-4703JB	2	Tip – High (white)	004-650050-PT	2
5	Shield Holder	001-4703JC	2	Tip – High (orange)	004-XR11001VS	1
6	Hose clamp	003-9002	7	Tip – High (blue)	004-XR11003VS	1
7	Lynch pin	008-4576	2	Tip – High (grey)	004-XR11006VS	1
8	Nozzle Cap	004-4723	5			
9	Nozzle body	004-4722	5			
10	Elbow	003-EL1414F	2			
11	Tee	003-TT14SQ	2			
12	Straight fitting	003-A1414	5			
13	Elbow	003-SE14F	1			
14	Hose	002-9016	2			
15	Tip strainer	004-4213-200	5			

## Harvest Tec Model 4517B Installation Kit For John Deere 8 & 9 Series Round Balers

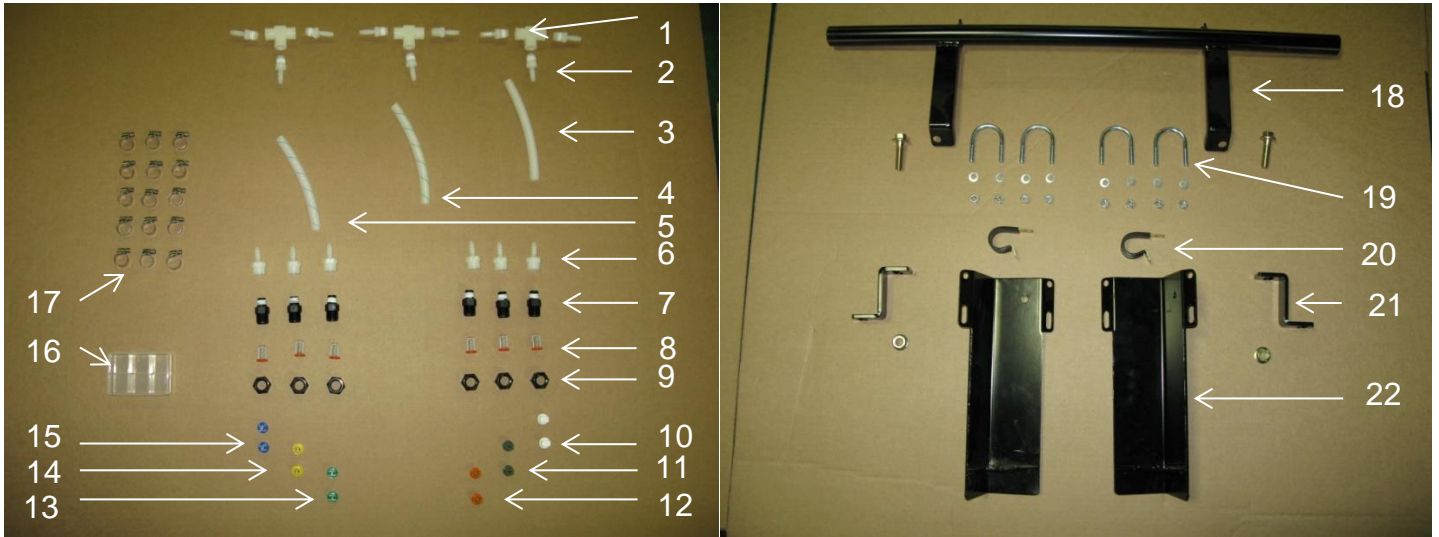

<u>Ref</u>	<u>Description</u>	<u>Part #</u>	<u>Qty</u>	<u>Ref</u>	<u>Description</u>	<u>Part #</u>	<u>Qty</u>
1	Tee	003-TT14SQ	3	13	Tip-green	004-XR110015VS	2
2	Fitting	003-A1414	9	14	Tip-yellow	004-XR11002VS	2
3	Hose-White	002-9016	4ft	15	Tip-blue	004-XR11003VS	2
4	Hose-Green Stripe	002-9016G	4ft	16	Mini Plano Box	008-9001	1
5	Hose-Blue Stripe	002-9016B	4ft	17	Hose Clamps	003-9002	15
6	Fitting	003-A1414F	6	18	Nozzle Holder	001-4703R	1
7	Fitting	003-4722	6	19	8mm U Bolt	001-4714UBS	4
8	Strainer	004-4213-200	6	20	Jiffy Clips	008-9009	2
9	Fitting	004-4723	6	21	Spacer	001-4703NS	2
10	Tip-white	004-650050-PT	2	22	Nozzle Mount	001-4714J	2
11	Tip-olive	004-800067-PT	2	23	Saddle Leg	001-4703B	2
12	Tip-orange	004-XR11001VS	2	24	Right Mtg Bracket	001-4703DR	1
				25	Left Mtg Bracket	001-4703DL	1

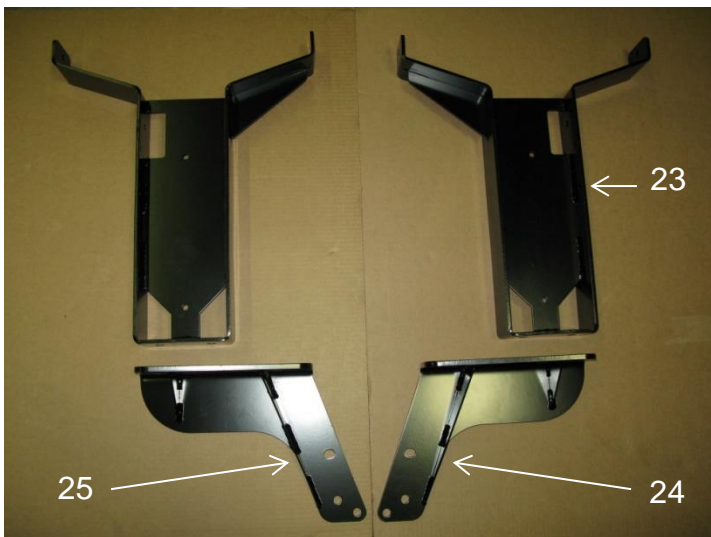

# Harvest Tec Model 4523B Installation Kit

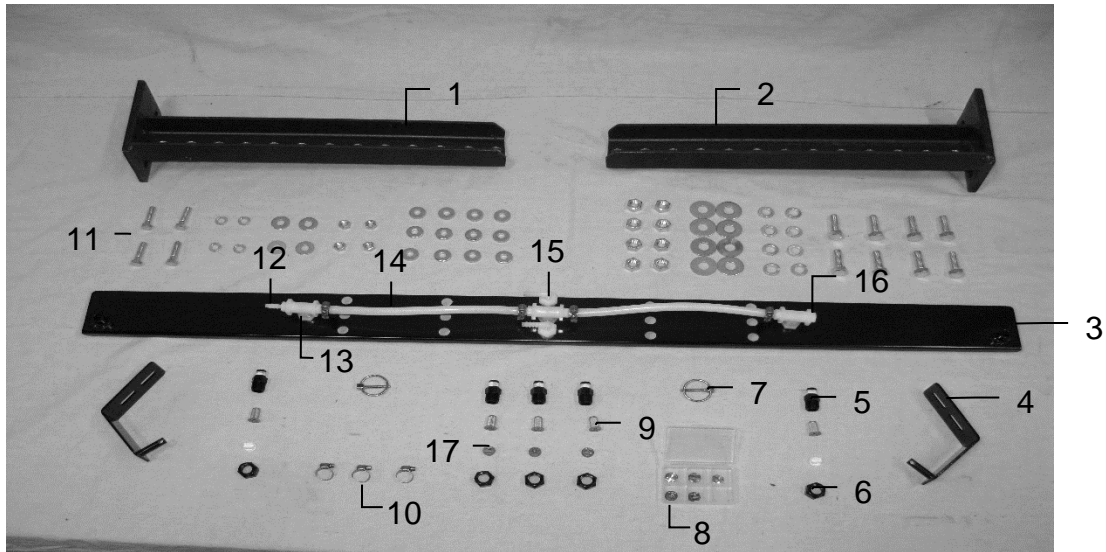

<u>Ref</u>	<u>Description</u>	<u>Part#</u>	<u>Qty</u>	<u>Ref</u>	<u>Description</u>	<u>Part#</u>	<u>Qty</u>
1	Left Support Leg	001-4704JL	1	15	1/4" Elbow FPT	003-EL1414F	2
2	Right Support Leg	001-4704JR	1	16	Hex Plug	003-F14	1
3	Spray Shield	001-4704G	1				
4	Lynch Pin	001-4704H	2	17	Tips		
5	Nozzle Body	004-4722	5		Low – Silver	004-650033-SS	3
6	Nozzle Cap	004-4723	5		Low – Green	004-XR11015VS	1
7	Lynch Pin	008-4576	2		Low – Red	004-XR11004VS	1
8	Plano Box	008-9001	1		High – White	004-650050-PT	2
9	Strainer w/Check	004-4213-200	5		High – Orange	004-XR11001VS	1
10	Hose Clamp	003-9002	7		High – Blue	004-XR11003VS	1
11	Hardware				High – Grey	004-XR11006VS	1
12	Straight Fitting	003-A1414	5				
13	Tee	003-TT14	3				
14	1/4" Hose	002-9016	2 ft				

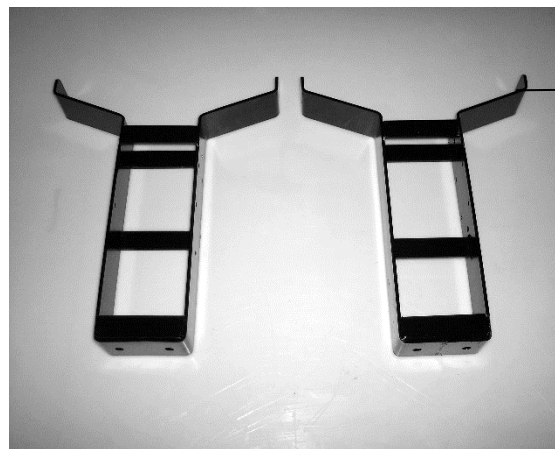

Tank Mounting Legs  
001-4703B (x2)

## Harvest Tec Model 4524B Installation Kit

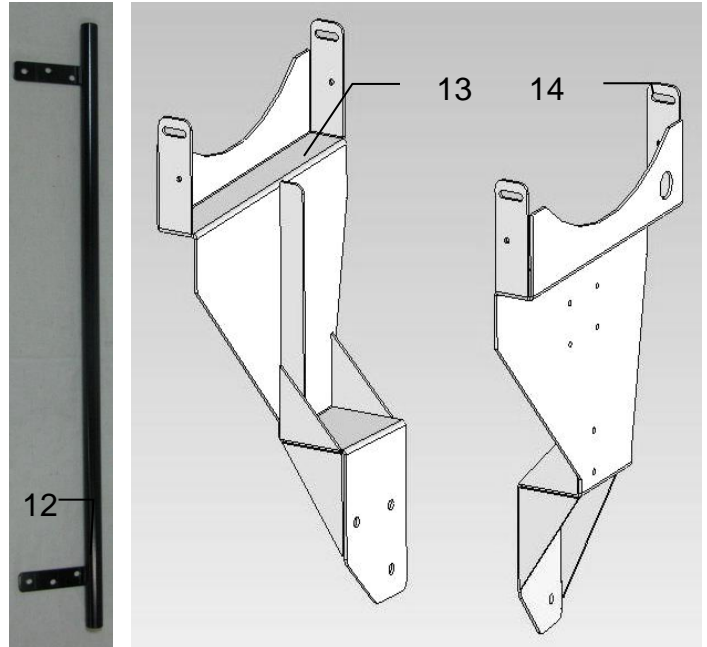
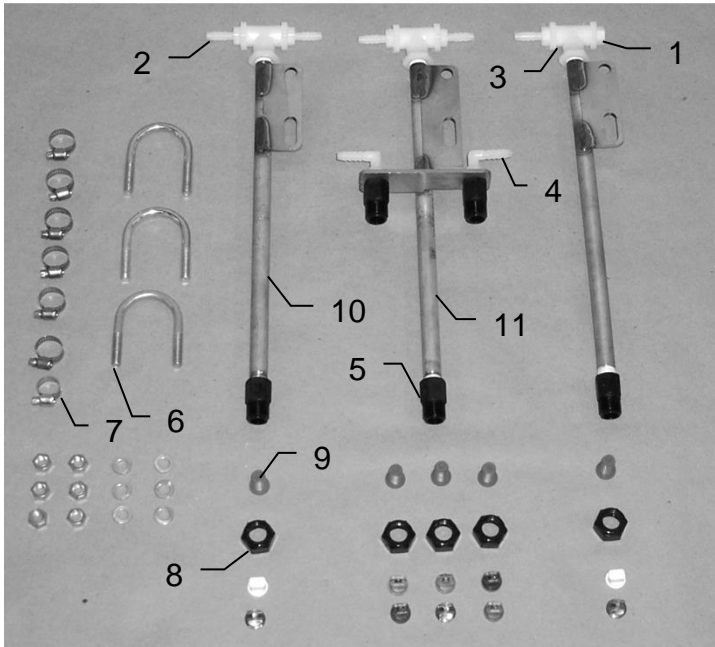

<u>Ref</u>	<u>Description</u>	<u>Part#</u>	<u>Qty</u>	<u>Description</u>	<u>Part#</u>	<u>Qty</u>
1	Plug	003-F14	1	Tip – Low (silver)	004-650033-SS	3
2	Straight fitting	003-A1414	5	Tip – Low (green)	004-XR110015VS	1
3	Tee	003-TT14	3	Tip – Low (red)	004-XR11004VS	1
4	Elbow	003-EL1414	2	Tip – High (white)	004-650050-PT	2
5	Nozzle body	004-4721	5	Tip – High (orange)	004-XR11001VS	1
6	U bolt	001-4714UBS	3	Tip – High (blue)	004-XR11003VS	1
7	Hose clamp	003-9002	7	Tip – High (grey)	004-XR11006VS	1
8	Nozzle cap	004-4723	5			
9	Tip strainer with check	004-4213-200	5			
10	Nozzle tube	001-4714	2			
11	Nozzle tube auto	001-4714A	1			
12	Nozzle holder	001-4703R	1			
13	Left leg	001-4703L	1			
14	Right leg	001-4703K	1			



## Model 4547B Installation Kit John Deere 0 Series Round Balers

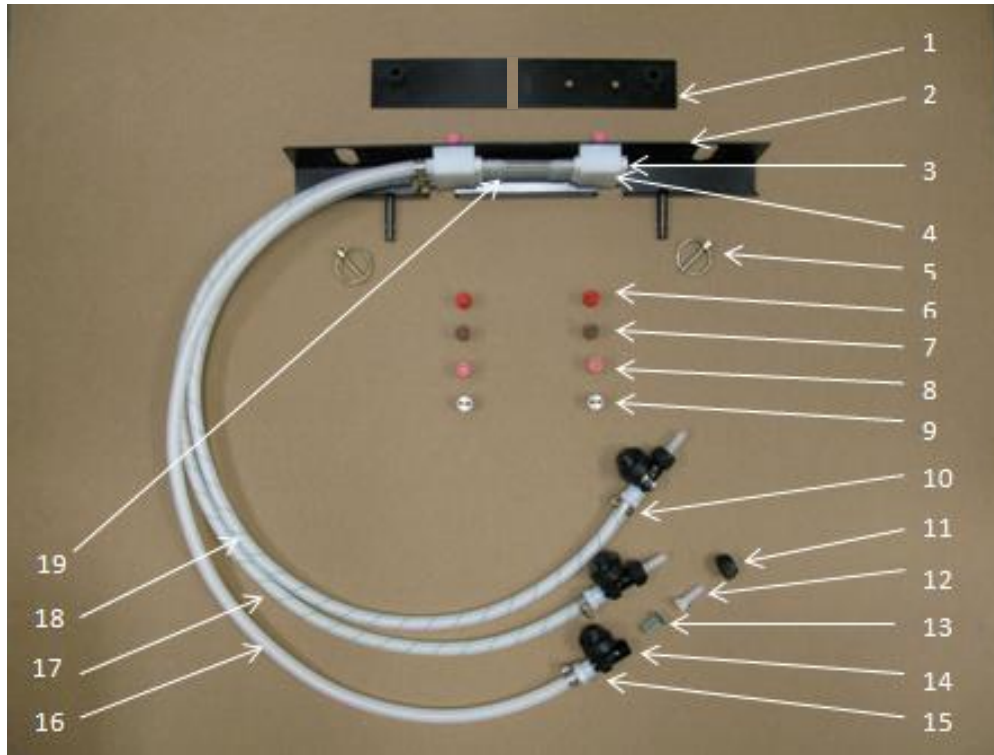

<u>Ref</u>	<u>Description</u>	<u>Part Number</u>	<u>Qty</u>	<u>Ref</u>	<u>Description</u>	<u>Part Number</u>	<u>Qty</u>
1	Holder	001-4435NCX	1	13	Strainer	004-1203-100	3
2	Shield	001-4435NSX	1	14	Check Valve	004-1207VB	3
3	Fitting	003-F14	3	15	Fitting	003-A1414F	3
4	Manifold Block	001-4435NSB	2	16	Clear Tubing-1/4"	002-9016	4 ft
5	Lynch Pin	008-4576	2	17	Blue Stripe Tubing	002-9016B	4 ft
6	Tip-Red	004-T8003-PT	2	18	Green Stripe Tubing	002-9016G	4 ft
7	Tip-Brown	004-T80015-PT	2	19	EVA-1/4"	002-9006	1 ft
8	Tip-Pink	004-T8001-PT	2	20	Saddle Leg	001-4703B	2
9	Tip-Stainless	004-T800067-SS	2	21	Right Mtg Bracket	001-4703DR	1
10	Hose Clamp	003-9002	15	22	Left Mtg Bracket	001-4703DL	1
11	Cap	004-4723	3	NP	1/4" x 1/4" Fitting	003-A1414	9
12	Fitting	003-A1414VB	3	NP	2" U-Bolt	001-4714UBX	2



## 647 & 649 Selecting Tips-Reference Guide

The applicator is sent from the factory with High output tips installed. The tips used are determined by how many ton per hour you are baling. You can see this on either the automatic or manual screen.

1 – 6 tons of hay per hour

- Too low for system to apply at. Increase baling speed or rake more hay together. System will show over application when at these tonnages.

8 - 27 tons of hay per hour 32 - 440lbs of hay preservative per hour (14-200L/hr)

- Use low output tips
  - o For most balers
    - Pump 1 = Qty 3 - (650033-SS) Silver
    - Pump 2 = Qty 1 - (XR110015VS) Green
    - Pump 3 = Qty 1 - (XR11004VS) Red
  - o For John Deere 8 and 9 Series balers (2013 and newer)
    - Pump 1 = Qty 2 – (650050-PT) White
    - Pump 2 = Qty 2 – (800067-PT) Olive
    - Pump 3 = Qty 2 – (XR11002VS) Yellow

21 - 40 tons of hay per hour 84 - 632lbs or hay preservative per hour (38-287 L/hr)

- Use high output tips
  - o For most balers
    - Pump 1 = Qty 2 - (650050-PT) White and Qty 1 (XR11001VS) Orange in the center
    - Pump 2 = Qty 1 - (XR11003VS) Blue
    - Pump 3 = Qty 1 - (XR11006VS) Gray
  - o For John Deere 8 and 9 Series balers (2013 and newer)
    - Pump 1 = Qty 2 – (XR11001VS) Orange
    - Pump 2 = Qty 2 – (XR110015VS) Green
    - Pump 3 = Qty 2 – (XR11003VS) Blue

## 647C Selecting Tips-Reference Guide

The applicator is sent from the factory with High output tips installed. The tips used are determined by how many ton per hour you are baling. You can see this on either the automatic or manual screen.

1 – 6 tons of hay per hour

- Too low a level for the system to apply at. Increase baling speed or rake more hay together. System will show over application when at these tonnages.

8 - 27 tons of hay per hour 32 - 440lbs of hay preservative per hour (14-200L/hr)

- Use low output tips
  - o For most 4 ft balers
    - Pump 1 = Qty 2    004-T800067-SS    80 degrees    Silver
    - Pump 2 = Qty 2    004-T8001-PT        80                Pink
    - Pump 3 = Qty 2    004-T80015-PT      80                Brown

21-40 tons of hay per hour 84 – 632lbs or hay preservative per hour (38-287 L/hr)

- Use high output tips
  - o For most 5 ft balers
    - Pump 1 = Qty 2    004-T8001-PT        80 degrees    Pink
    - Pump 2 = Qty 2    004-T80015-PT      80                Brown
    - Pump 3 = Qty 2    004-T8003-PT      80                Red



# Notes

# Notes

## **Harvest Tec Inc. Warranty and Liability Agreement**

Harvest Tec, Inc. will repair or replace components that are found to be defective within 12 months from the date of manufacture. Under no circumstances does this warranty cover any components which in the opinion of Harvest Tec, Inc. have been subjected to negligent use, misuse, alteration, accident, or if repairs have been made with parts other than those manufactured and obtainable from Harvest Tec, Inc.

Our obligation under this warranty is limited to repairing or replacing free of charge to the original purchaser any part that in our judgment shows evidence of defective or improper workmanship, provided the part is returned to Harvest Tec, Inc. within 30 days of the failure. If it is determined that a non-Harvest Tec branded hay preservative has been used inside the Harvest Tec applicator system where the failure occurred, then Harvest Tec reserves the right to deny the warranty request at their discretion. Parts must be returned through the selling dealer and distributor, transportation charges prepaid.

This warranty shall not be interpreted to render Harvest Tec, Inc. liable for injury or damages of any kind, direct, consequential, or contingent, to persons or property. Furthermore, this warranty does not extend to loss of crop, losses caused by delays or any expense prospective profits or for any other reason. Harvest Tec, Inc. shall not be liable for any recovery greater in amount than the cost or repair of defects in workmanship.

There are no warranties, either expressed or implied, of merchantability or fitness for particular purpose intended or fitness for any other reason.

This warranty cannot guarantee that existing conditions beyond the control of Harvest Tec, Inc. will not affect our ability to obtain materials or manufacture necessary replacement parts.

Harvest Tec, Inc. reserves the right to make design changes, improve design, or change specifications, at any time without any contingent obligation to purchasers of machines and parts previously sold.

Revised 4/17

**HARVEST TEC, INC.**  
**P.O. BOX 63**  
**2821 HARVEY STREET**  
**HUDSON, WI 54016**  
PHONE: 715-386-9100  
1-800-635-7468  
FAX: 715-381-1792  
Email: [info@harvesttec.com](mailto:info@harvesttec.com)