

Operation Manual

Model 644A, 645A, 650A & 651A

25 & 55 Gallon Automatic Preservative Applicator



HayBoss™
G2

(intentionally blank)

Harvest Tec 644, 645, 650 & 651 Operation Table of Contents

	<u>PAGE</u>
Introduction	4
Model Reference Chart	4
Operation of Applicator	5-13
Operation	5
Turn iPad On/Off	5
Downloading Hay App	5
iPad Integration Control Module	6
iPad Integration Control Light Signals	6
Bluetooth Receiver Lights	6
Shutting Down the Hay App	7
Device Selection	8
Manual & Recommended Preservative	9
Tab Descriptions	10
Screen Menus	11
Setup Mode	12
Job Records	13-14
First Time and Annual Startup Instructions	15
Setting up the System for Initial Use	16-17
Application Rate	16
Baling Rate & Stroke Counter Setup	17
Operation Instructions	18-23
Automatic Mode	17
Manual Mode	19
Job Records	20
Download Job Records	21
Export Job Records	22-23
Wiring Diagram	24
Common Questions	25
Troubleshooting	26-27
iPad Troubleshooting	28
Maintenance, Winter Storage	29
Status Alerts	29
Pin Outs	30-31
Parts Breakdown	32-43
Model 644 & 645 Base Kit	32
Model 650 & 651 Base Kit	33
Pump Plate	34
Star Wheels, Bale Rate Sensor, and Hoses	35
Drain / Fill Kit	35
Control Boxes and Wiring Harnesses	36
Installation Kits	37-43
Model 4410B	37
Model 4415B-SO	38
Model 4415B	39
Model 4416B	40
Model 4485B	41
Model 4502B	42
Model 4506B	43
Model 4507B	44
Optional iPad Mini Mount Kit	45
Notes	46
Warranty Statement	47

Introduction

Thank you for purchasing a Harvest Tec Model Hay Preservative Applicator. This 662 applicator system has been designed to operate through an Apple iPad (not included) using the Hay App. As well as plug directly into most tractors that have an ISOBUS Monitor. The Applicator System offers these advantages by operating through an Apple iPad:

1. Large bright, clear, colorful display
2. More durable and can be read in bright sunlight
3. Can be used for multiple other uses than just the applicator display
4. Option to tie-into the tractor ISOBUS system

The Hay Preservative Applicator System is designed to apply buffered propionic acid to the forage crop as it is baled and will adjust the rate of application based on moisture and tonnage of the crop being harvested. This manual will take you through the steps for installing the applicator. If you are unsure about installing the system after consulting this manual, contact your local authorized dealership for additional assistance. For your convenience a parts breakdown is located in the back of this manual, contact your local authorized dealer to order the parts. This applicator is designed to apply Harvest Tec buffered propionic acid.

***Made for iPad® (3rd through Pro 2nd generation), running the current iOS operating system or one version previous required for iPad option**

*iPad is a trademark of Apple Inc., registered in the U.S. and other countries.

****600 Series Applicators with serial number before DCP27000 will require the DCP to be sent to Harvest Tec for a required update in order to use the iPad Integration Module (030-6672C).**

Model Reference Chart

<u>Baler Make</u>	<u>Baler Model</u>	<u>Model Number</u>	<u>Install Kit</u>
CASE IH	SBX530, SBX540, SBX550, SB 531 – SB 551	651	4415B
NEW HOLLAND	570, 575, 580 & BC 5060 – BC 5080	651	4415B
CASE IH	2001 AND OLDER SQUARE BALERS (TWO TIE)	650	4485B
HESSTON, MASSEY NEW IDEA, AND CHALLENGER	ALL CONVENTIONAL SQUARE (TWO TIE) BALERS	650	4485B
HESSTON, MASSEY NEW IDEA, AND CHALLENGER	ALL THREE TIE BALERS	650	4502B
FREEMAN	ALL THREE TIE BALERS	650	4506B
NEW HOLLAND	BB 900 & 585	650	4507B
JOHN DEERE	ALL SMALL SQUARE BALERS	645	4410B

Operation

Turn On / Off iPad using the Sleep/Wake button

*(Info from Apple User's Guide)

Turn iPad on. Hold down the Sleep/Wake button until Apple logo appears. iPad will take a moment to load.

You can lock iPad and put it to sleep when you're not using it. Locking iPad puts the display to sleep, saves the battery, and prevents anything from happening if you touch the screen.

Sleep/Wake



When you are not going to use the iPad for an extended period of time put the unit into sleep mode by pressing the Sleep/Wake button. Press Sleep/Wake button to wake iPad and then unlock iPad by entering passcode.

Turn iPad off. Hold down the Sleep/Wake button for a few seconds until the slider appears onscreen, then drag the slider to the right.

Downloading Harvest Tec App

1. If iPad does not have Wi-Fi turned on, select the Settings tab  then select the Wi-Fi tab (below).

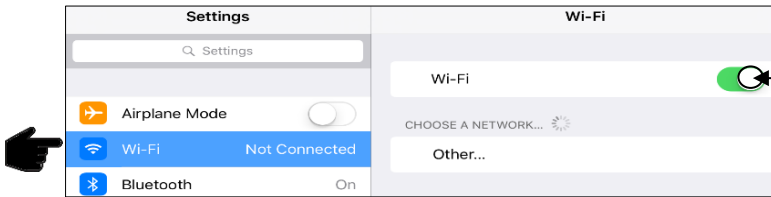

2. Turn Wi-Fi on by sliding button to the right.
*Green bar indicates ON

3. Use same process to turn on Bluetooth function

4. Select an available network when detected by the iPad, shown in area above that currently says 'Other.'

5. Select App Store icon (below) and open. *You will need a Wi-Fi connection available to view App Store.



****The Harvest Tec system WILL NOT appear under the Bluetooth tab in the Setting App. Open the Hay App to connect.**

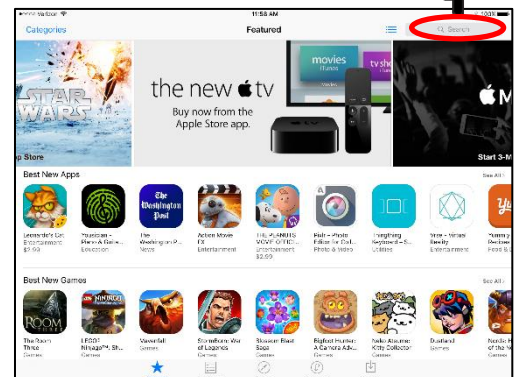

Download the Hay App in the App Store by searching for 'Hay App' in the search bar in the top right corner of screen (right):

*The advertisements displayed on the App Store screen will change.

The app will have the icon as shown:



Hay App

Note: Made for iPad® (3rd through Pro 2nd generation), running the current iOS operating system or one version previous required for iPad option

iPad Integration Control Module

030-6672C

To operate the applicator, connect the iPad cord to the iPad Integration Control in the port indicated by:

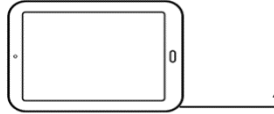

iPad Integration Control Light Signals

Green Slow Blink – Power supplied to the applicator system and the unit is going through its startup process. This will take approximately 25-35 seconds.



Green Double Blink – Indicating the iPad module recognizes the iPad but the app is not open or connected.

Green Solid Light – Module is connected to the app and is ready to operate.

*Recommended to use the USB cable included with the applicator kit (006-6672USBC)

Bluetooth Receiver Lights

Pre-2020 applicators equipped with Bluetooth receivers (030-6672B) are now equipped with lights to indicate both power and Hay App connection on the Apple iPad. Clean light regularly

Blinking Lights – System is waiting for the processor to connect, which could take up to 35 seconds.

Red Light – The Bluetooth receiver has power

Green Light – The Bluetooth receiver is connected to the Hay App.



****600 Series Applicators with serial number before DCP27000 will require the DCP to be sent to Harvest Tec for a required update in order to use the iPad Integration Module (030-6672C).**

Hay App version must be **at least 2.5.18 (or higher)** to operate with the iPad Integration Module

*Made for Apple iPad badge

Use of the Made for Apple iPad badge means that an accessory has been designed to connect specifically to the Apple product(s) identified in the badge and has been certified by the developer to meet Apple performance standards. Apple is not responsible for the operation of this device or its compliance with safety and regulatory standards.

Please note that the use of this accessory with an Apple product may affect wireless performance.

Shutting Down the Hay App

To shut down the Hay App double click the home button (Figure A). This will show the open apps that are running on your iPad (Figure B).

*Note: By pressing the home button one time to return to the home screen, the Hay App **does not** shut down. The system will however, stop applying preservative after 10 seconds.



Figure A

Slide the app you want to shut down by sliding the app toward the top of the iPad, until the app is no longer visible (Figure C).

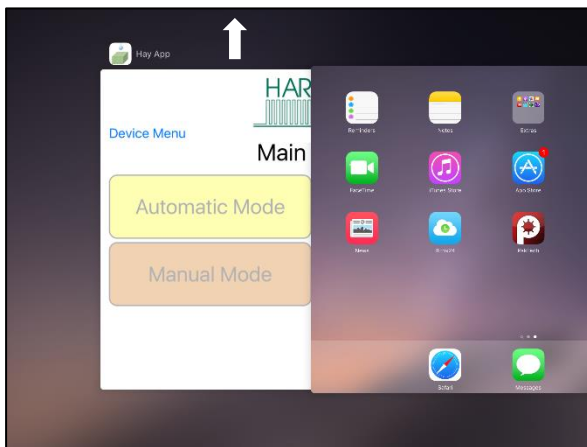

Figure B

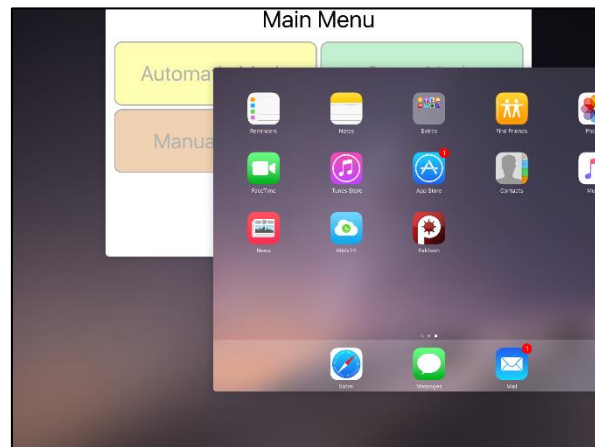

Figure C

Operating the Harvest Tec iPad App

When ready to operate your applicator system, open the Hay App on the iPad by selecting the Hay App icon.

Device Selection

The app will open to the Device Menu screen as shown below.

Pre-2020 applicators which are equipped with the Bluetooth receiver (030-6672B) that are within range (20') of the iPad and have power going to them, will be shown under the Active Connections section (below) after the initial startup of the system (35-45 seconds).

Production year 2020 applicator systems and beyond will include the iPad Integration Module 030-6672C. When plugging in the iPad cord to the module the app will change to the applicator Main Menu for immediate operation. Unplug the cord to return to the Device Menu page.

*Hay App version must be **at least 2.5.18 (or higher)** to operate with the iPad Integration Module (030-6672C)

After the iPad connects to the Bluetooth receiver, select the applicator you want to connect with.

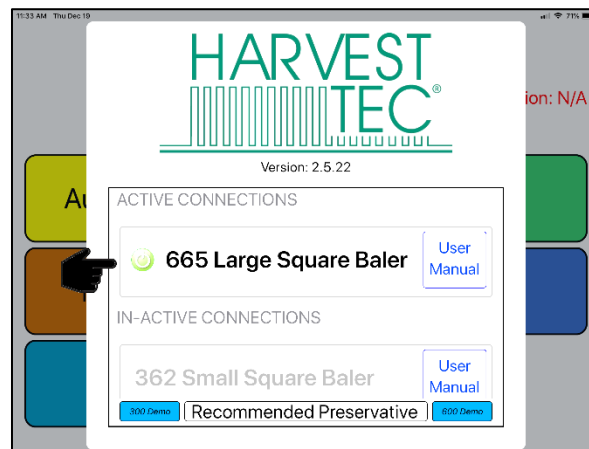

The In-Active Connections section will show applicator systems that have been connected in the past, but are not within range of the iPad or do not currently have power going to them (bottom left).

To remove a baler from the In-Active list, slide the bar displaying the baler name to the left, and select the Delete button that will appear (bottom right).

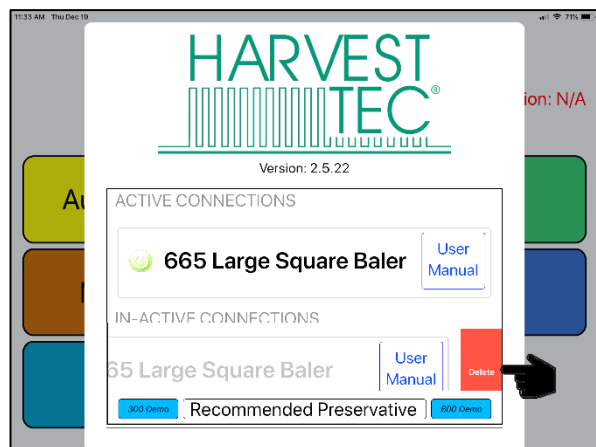
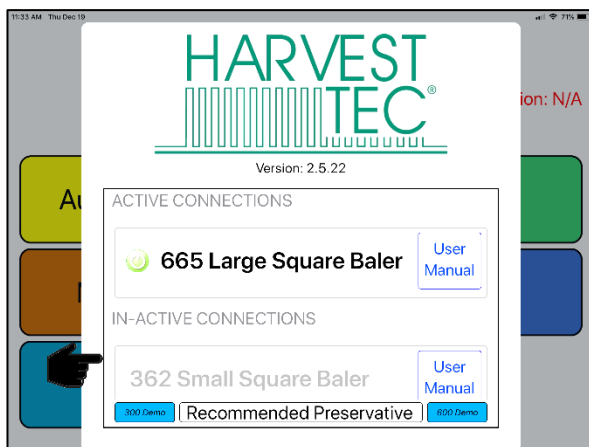

Operating the Harvest Tec iPad App (continued)

Demo Mode

Selecting the 300 Demo or 600 Demo button (below) will allow you to view the different screens of the applicator without requiring connection to an applicator system.

*This function is intended to be used as a visual aid, no values will be displayed.

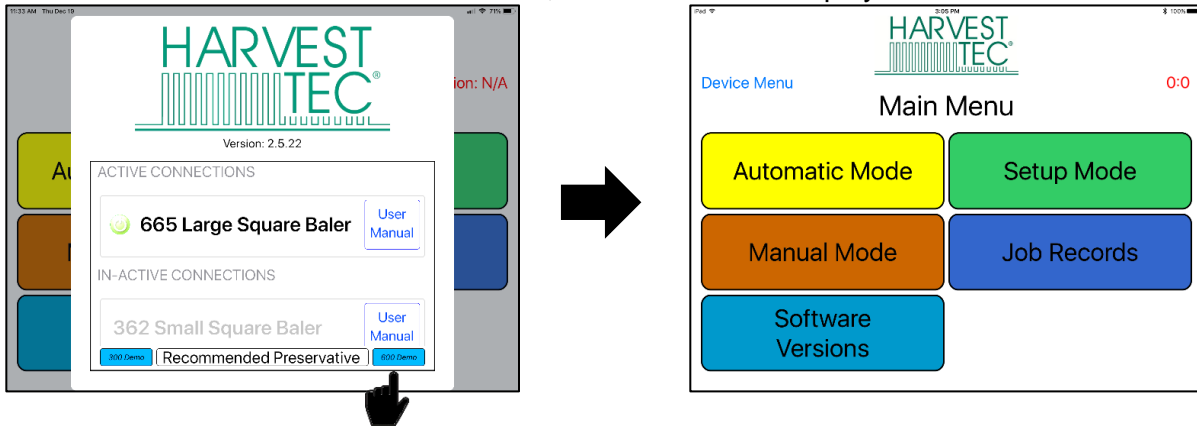

Manual Selection

Selecting the Manual button (below) displayed to the right of the baler name will open the operation manual for your baler.

*You do not need to be connected to a baler to open the manual and recommended preservative tabs after a baler has been connected.

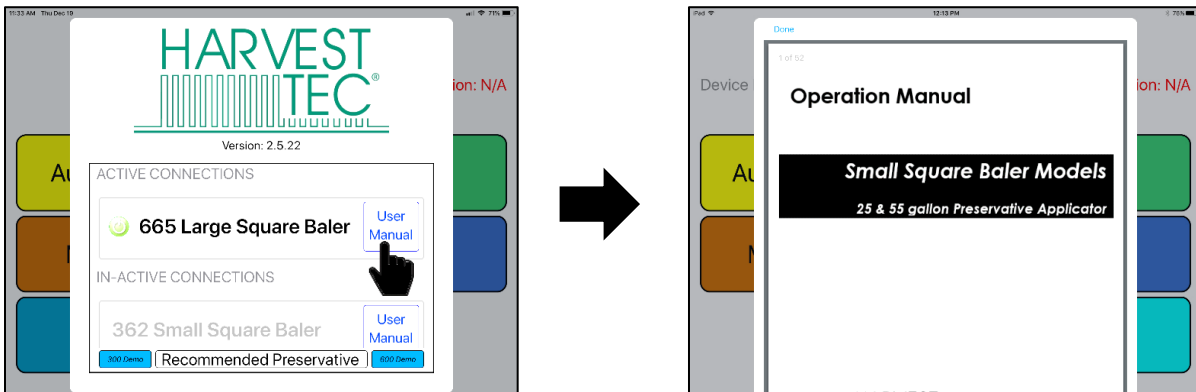

Recommended Preservative

To view recommended preservative information, application rates, and frequently asked preservative questions, select Recommended Preservative (below).

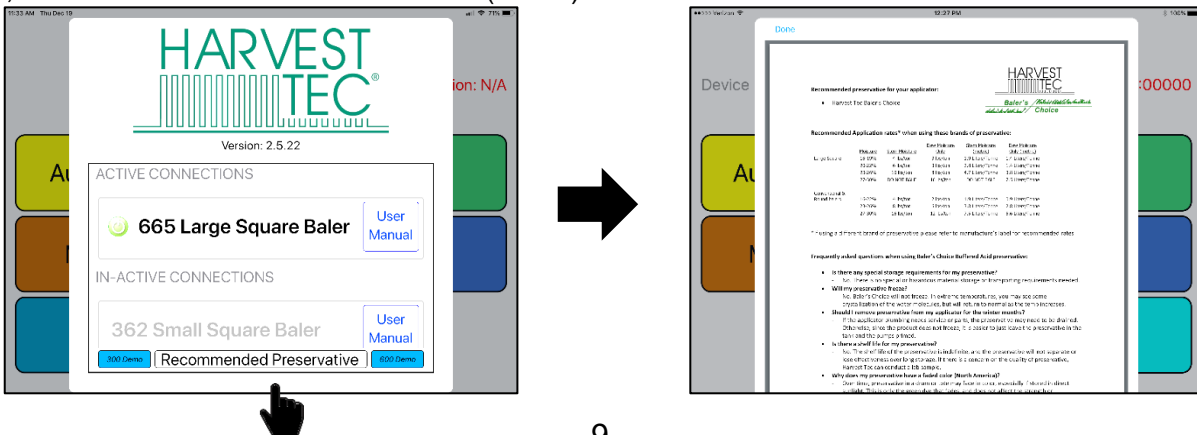

Operating the Harvest Tec iPad App (continued)

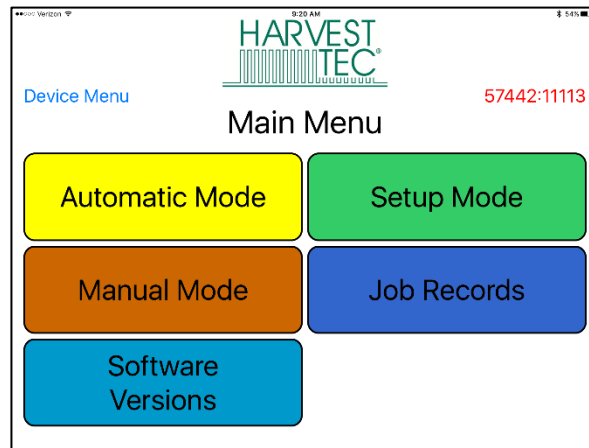

Tab Descriptions

Automatic Mode: This mode allows you to use all of the applicator features such as adjusting preservative application on the go and counting total pounds of product used.

Manual Mode: Allows operator to manually turn pumps on and off. This mode also has moisture content displayed. Use this mode to prime pumps.

Software Versions: Selecting this tab will display the software currently installed.

Setup Mode: This mode allows the operator to adjust bale rate, application rate settings and select tip output.

Job Records: Keep track of up to 300 jobs with total product used, average moisture content, tons baled, and baling date.

Screen Menus

Use the screen shots below to navigate through the operation screens.

Automatic Mode

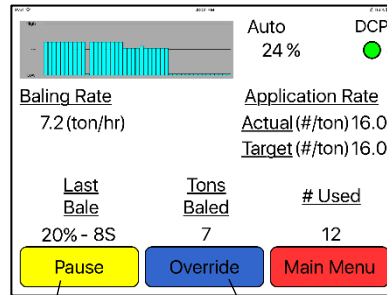
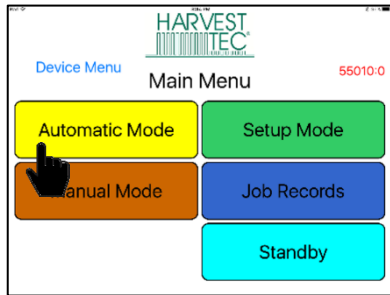

Bluetooth Connection Indicator
 Green -DCP is connected
 Yellow -DCP connecting
 Red -DCP not connected

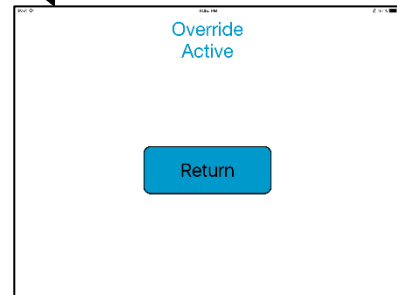
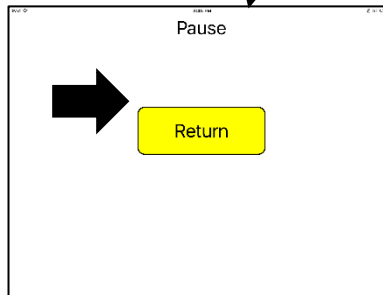

Manual Mode

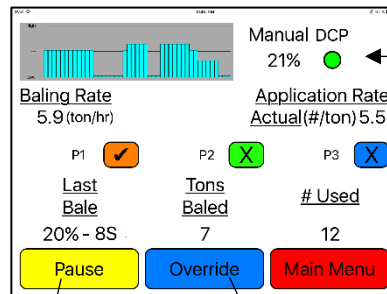
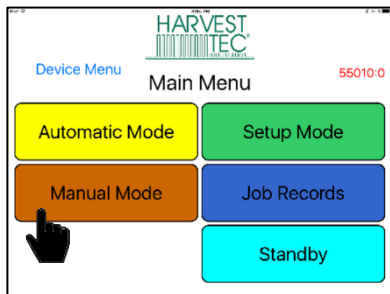

Bluetooth Connection Indicator
 Green -DCP is connected
 Yellow -DCP connecting
 Red -DCP not connected

X -Pump is OFF
 ✓ -Pump is ON

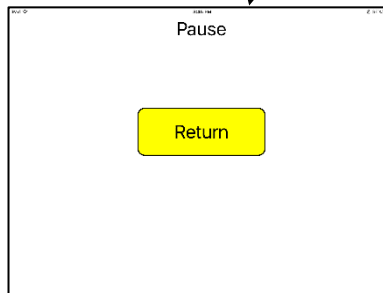

Operation Note:

Pressing the Home Button on the iPad **WILL NOT** stop application of the Harvest Tec System (see below):

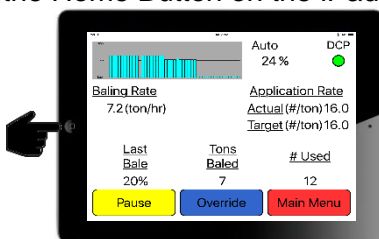

Select **Pause** or **Main Menu** to stop application

*To close app see the Shutting Down Hay App Section

Setup Mode

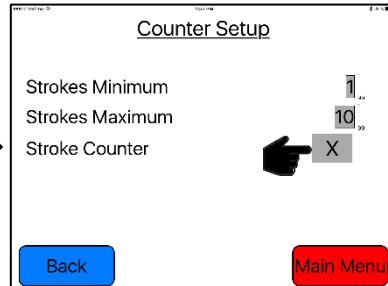
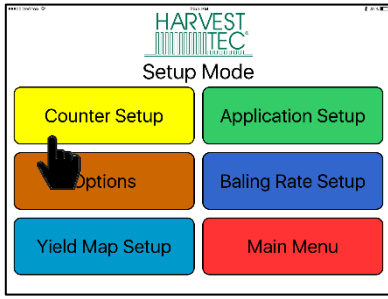

Turn on Stroke Counter by selecting X, Adjust min/max by selecting grey areas

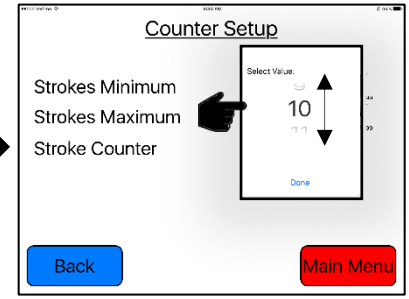

Scroll up or down to correct min/max
✓ Indicates Stroke Counter is ON

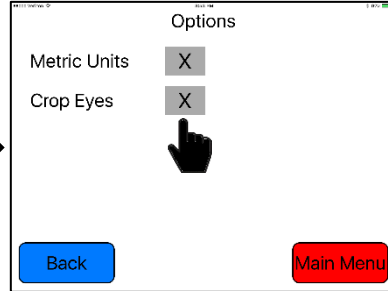
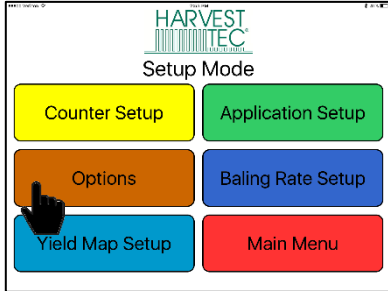

Select X to turn on options shown

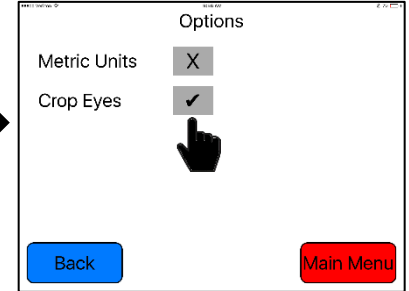

✓ Indicates Crop Eyes are ON

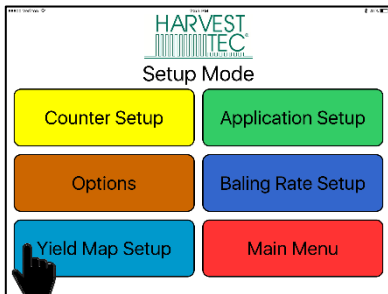

Only used if equipped with GPS

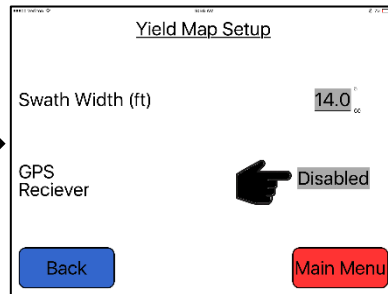

Select grey area to change

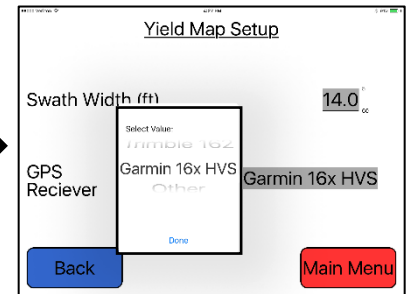

Select appropriate GPS unit

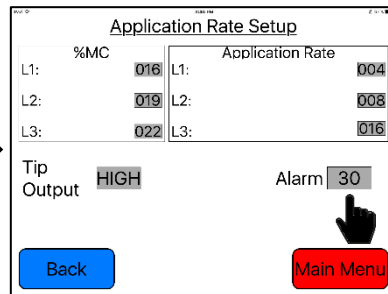
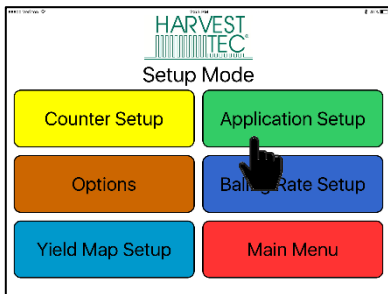

Adjust alarm setting by selecting the grey area

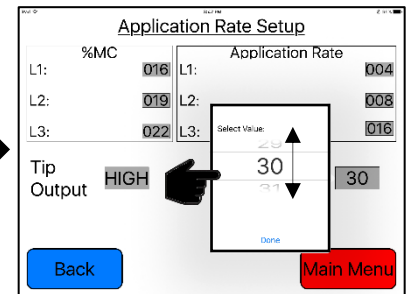

Select desired alarm setting by scrolling up or down

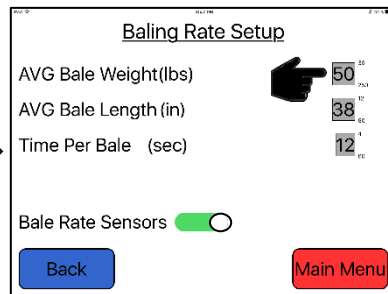
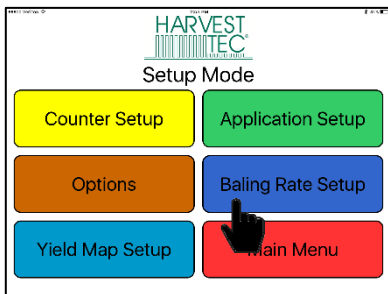

Input correct weight, length, time per bale

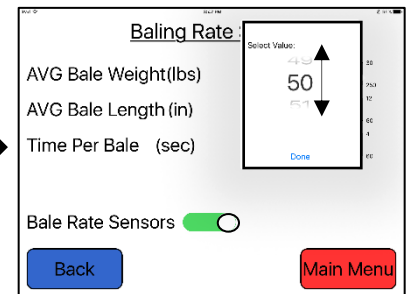

Select correct weight

Job Records

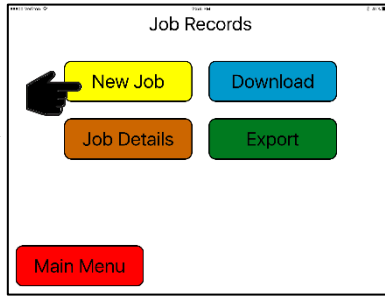
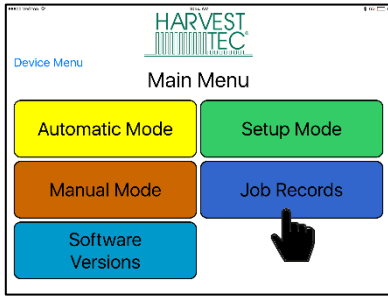

Type desired Field Name, select Create Job

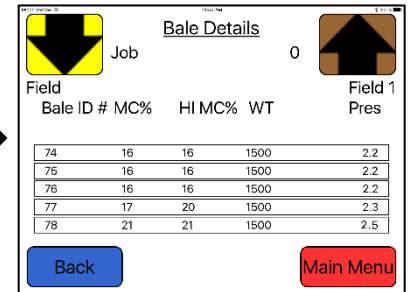
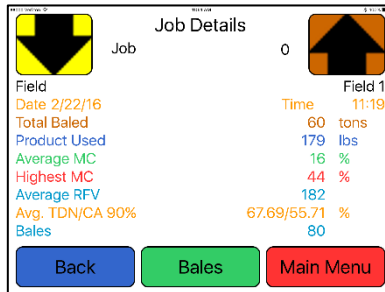
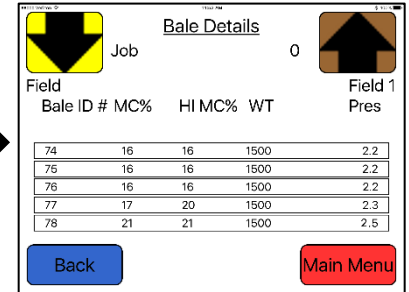
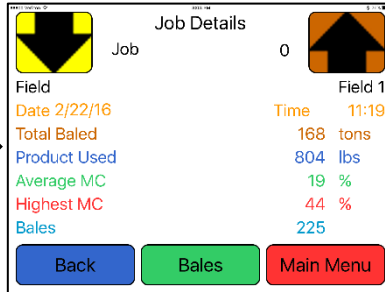
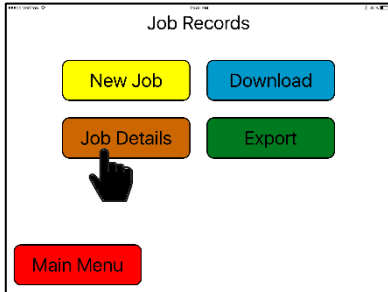

*When RFV Equipped, Average RFV, Ave TDN/CA90% info will be added

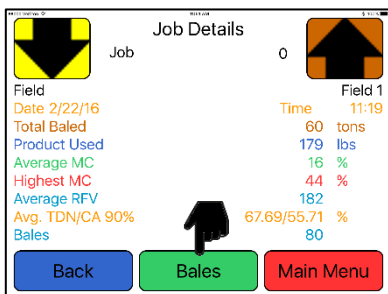

For Bale details select Bale Button

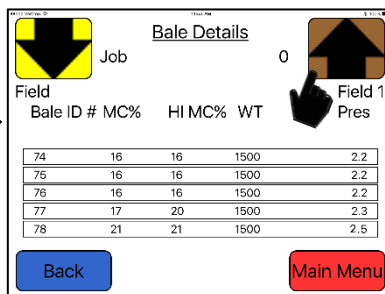

Use arrows to change jobs shown

Job Records (continued)

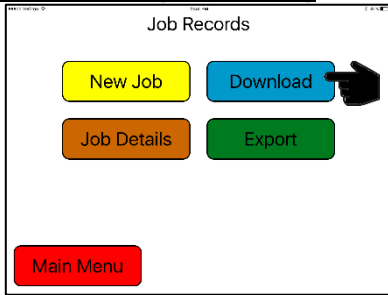

Select Download when wanting to download job records to USB Stick

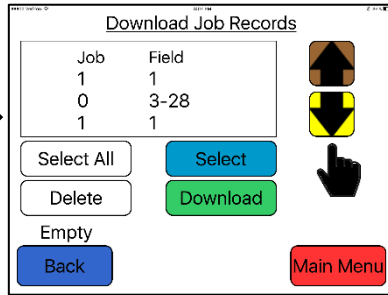

Use arrows to change jobs shown.
 ↕ Indicates selected jobs

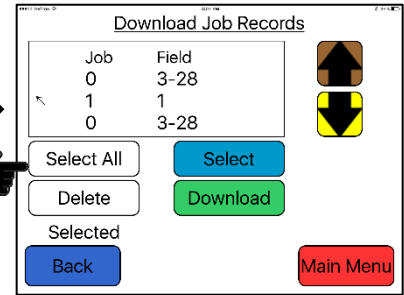

Pressing the Select or Select All tab to choose which job to download or delete.

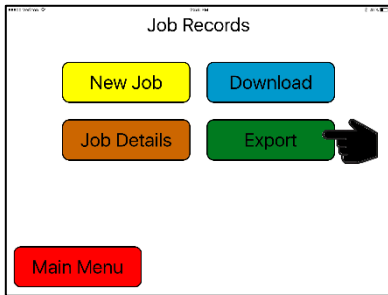

The Export allows you to send an email a file with selected job records

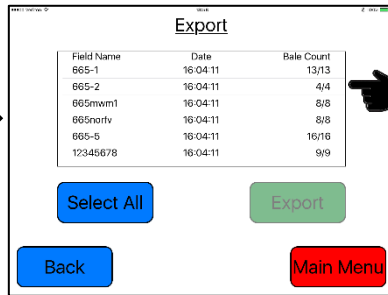

When the Export page is opened the bale information in each job will be retrieved.

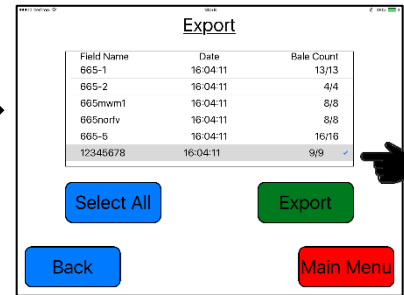

When all bales have been retrieved, Export tab will activate, select a job(s) to export



If choosing one job to email, select the Mail tab. Multiple jobs can be selected

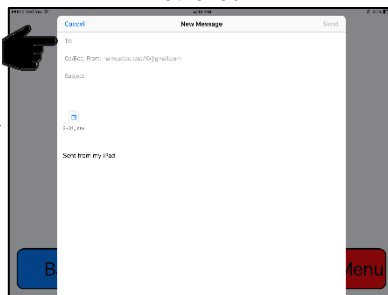

Email will appear w/file attached, enter address *Email appears w/ 2 or more

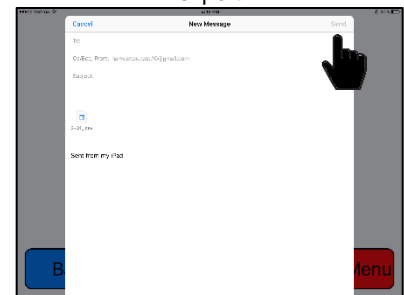

Press the Send button in top right corner, (your iPad notification sound will play)

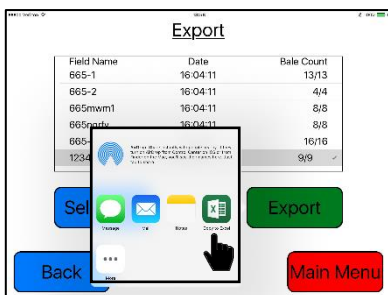

If choosing to view job on iPad, recommended to download Excel app to view job records information

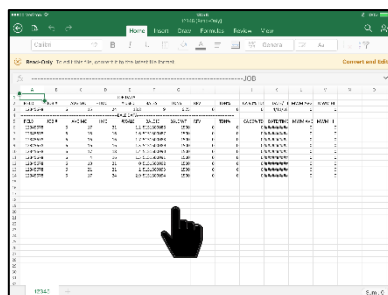

After Excel app is selected, the job record spreadsheet will open
*iPad can only view 1 job at a time.

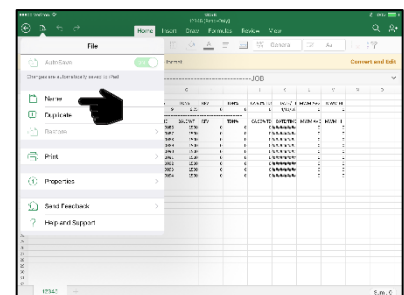

To save the job, select Name from the drop down tab

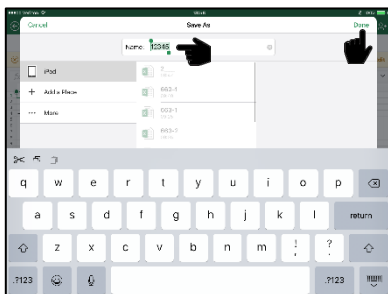

Enter desired name in center of page and press Save on the top right corner

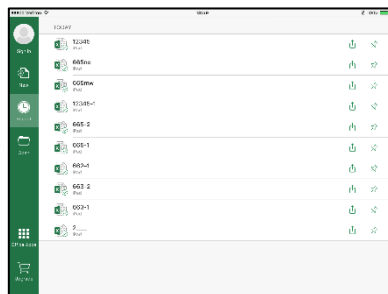

After selecting Save, the list of saved files in Excel will appear. Select any job to view

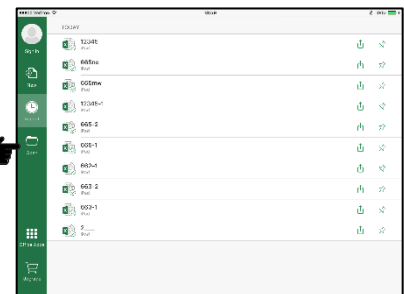

You also can view the jobs saved by selecting Open tab after opening the Excel app

First Time and Annual Startup Instructions

THE UNIT MUST BE CHECKED OUT BEFORE FIELD OPERATION!

Check and Prime the Pumps

1. Put 10 gal (5L) of water in tank and turn main ball valve on.
2. Inspect for any leaks or drips at this time. If any are found tighten or replace area or fitting.
3. Turn controller on.
4. Press the SETUP MODE key. Turn bale rate sensors off. Make sure the AVG Bale Weight is 100 lbs and the AVG Baler Length is 36" (92cm), Time per bale is 10 seconds, and press the MAIN MENU key to return to the opening screen.
5. Press the MANUAL MODE key and the screen shown below will appear.

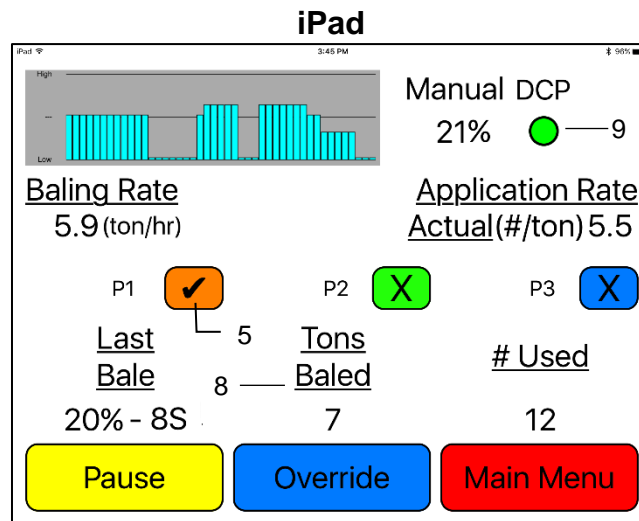

Note: The system comes with the tips already installed on the spray shield or nozzle tubes.

Pump	2-Tie Baler Tip Output (Lbs / Ton) (L/MT)	3-Tie Baler Tip Output (Lbs / Ton) (L/MT)
1	1.2 – 1.6 (.5 - .7L)	1.8 – 2.6 (.8 - 1.2L)
2	3.6 – 5.0 (1.6 - 2.3L)	3.6 – 5.0 (1.6 - 2.3L)
3	6.7 – 9.3 (3.0 - 4.2L)	10.0 – 13.4 (4.5 - 6.1L)

6. Turn pump 1 on (P1). To turn the pump on, select the colored box next to P1 and change the 'X' to a check mark Repeat the process for pumps 2 and 3 (P2 and P3).
7. This process will also be used to prime the pumps whenever needed.
8. While running pumps check for a good spray pattern out of the respective tips and verify that no parts of the system are leaking.
9. While doing these tests the Volume Used on the bottom of the screen will be increasing, this verifies that the flow meter is functioning.
10. The DCP button displays your connection signal with the Bluetooth receiver. Green – DCP is connected, Yellow – DCP is connecting, Red – DCP not connected. Pressing MAIN MENU key to return to the initial startup screen.

Setting Up the System for initial use with the iPad

In this mode you will setup your initial application rate and baling rate.

Application Rate

After pushing the SETUP MODE key in the Main Menu screen, the top left screen will appear:

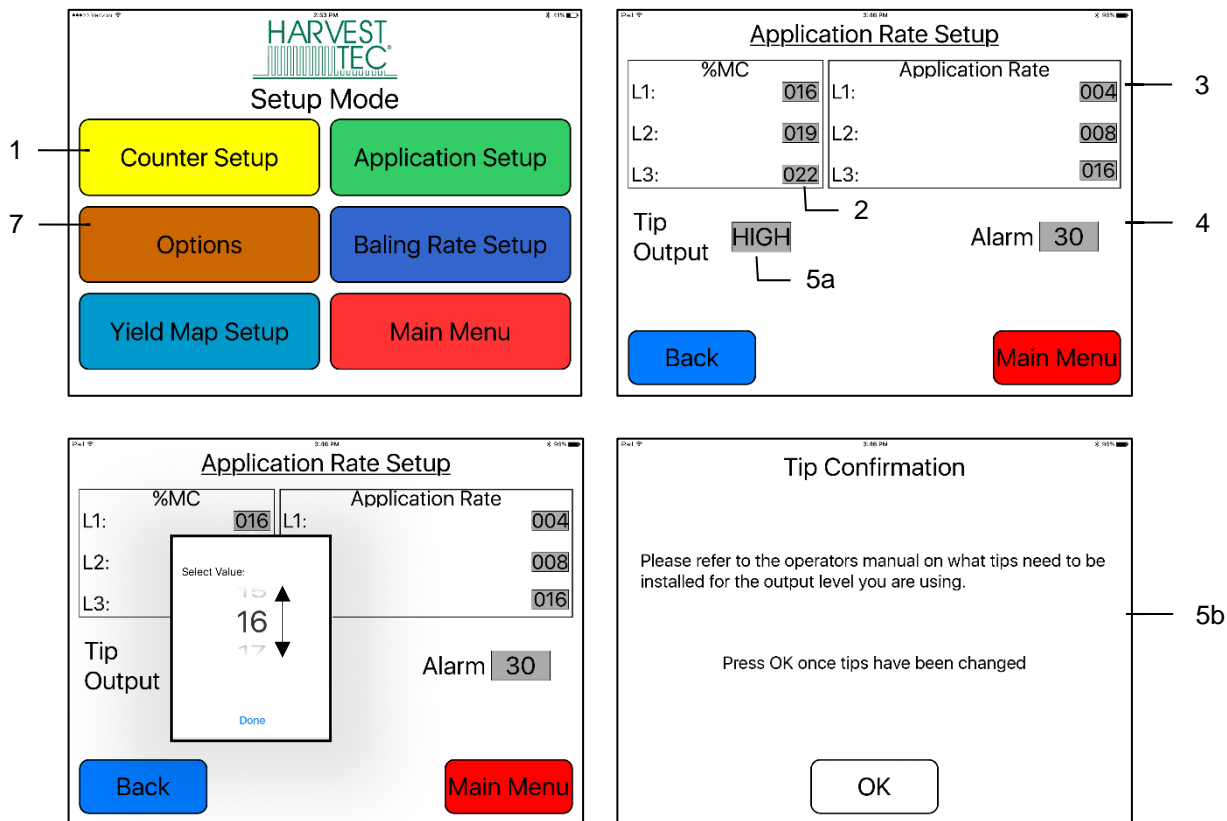

1. On the Setup Mode screen press the APPLICATION RATE key. Once selected the SETUP APPLICATION RATE screen will be shown. (Top right picture)
2. Press any of the grey number values to the right of %MC to adjust their figures. The scroll pad shown on the bottom left will display. Remember level 1 must be lower than level 2 and level 2 must be lower than level 3. Press Done, when value has been selected. Harvest Tec products recommend set points of 16, 22, and 26 % MC levels. These are preset from the factory. Press Back to return.
3. To change rate of chemical application, press any of the grey number values to the right of RATE. Remember level 1 must be lower than level 2 and level 2 must be lower than level 3. Press Done, when value has been selected. Harvest Tec products recommend rates of 4, 6, and 10 lbs/ton (2,3,5 L/MT). These rates are preset from the factory. Press Back to return to previous screen. **IT IS THE OPERATORS RESPONSIBILITY TO FOLLOW THE RECOMMENDATIONS OF THE PRESERVATIVE. ONLY THE OPERATOR CAN APPLY THE PROPER RATE.**
4. To set the alarm, press the grey number value and set the level at which you want the alarm to activate. To turn the alarm off, set level above 50.
5. Press the grey area next to Tip Output to **cycle between the high and low sets of tips** (5a). Use the correct tip set for the field conditions. The tip confirmation screen will appear (5b). Press OK once tips are changed.
6. Next press the BACK key found on the bottom left hand figure of the screen to return to SETUP MODE screen or press MAIN MENU key on bottom right hand figure of the screen to return to opening screen.
7. Press OPTIONS to adjust the unit between metric and standard units.

Baling Rate Settings

After pushing the SETUP MODE key in the Main Menu screen, the screen on the left will appear:

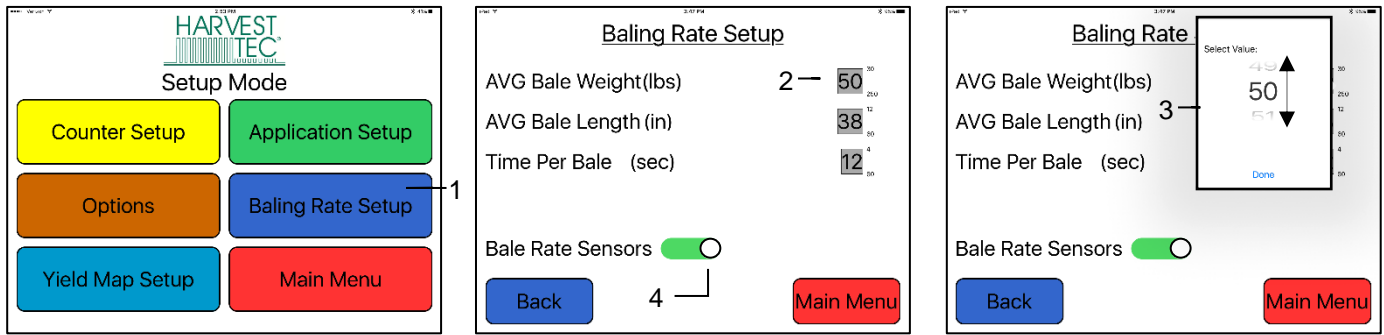

1. On the setup mode screen press the BALING RATE key.
 2. Press the grey number value to the right of AVG Bale Weight (Lbs).
 3. To adjust the weight of your bales, the scroll tool shown will display. Scroll through the values to select correct information, press DONE when value has been selected. The information will be saved until updated. Use the same procedure for adjusting bale length and time per bale.
 4. Small square balers are equipped with Bale Rate Sensors which can be turned ON by sliding the bar to the right as shown above. A green bar indicates that the bale rate sensors are on. While a grey bar means the bale rate sensors are off.
- Note: Bale rate sensors are used instead of a fixed time per bale to help determine a real time ton per hour reading.

Stroke Counter Setup

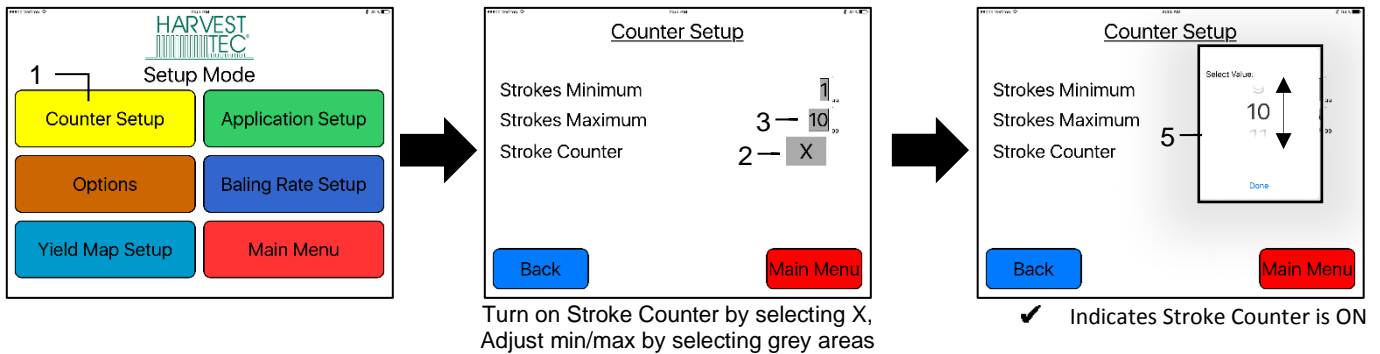

1. On the setup mode screen press the COUNTER SETUP key.
2. Turn on the stroke counter by select the X, which will change to an ✓, indicating the sensor is ON
3. Adjust the stroke maximum and minimum level by selecting the grey area on the right screen
4. Scroll through the values to select correct setting, press DONE when value has been selected

Operation Instructions

Automatic mode will automatically apply product based on hay moisture content sensed by the moisture sensors and the operator's presets. See SETTING UP SYSTEM FOR INITIAL USE to change any of these settings. **Manual mode will apply preservative to the hay at a fixed rate regardless of the moisture.**

Automatic Mode

After pushing the AUTOMATIC MODE key in the Main Menu screen, the following screen will appear:

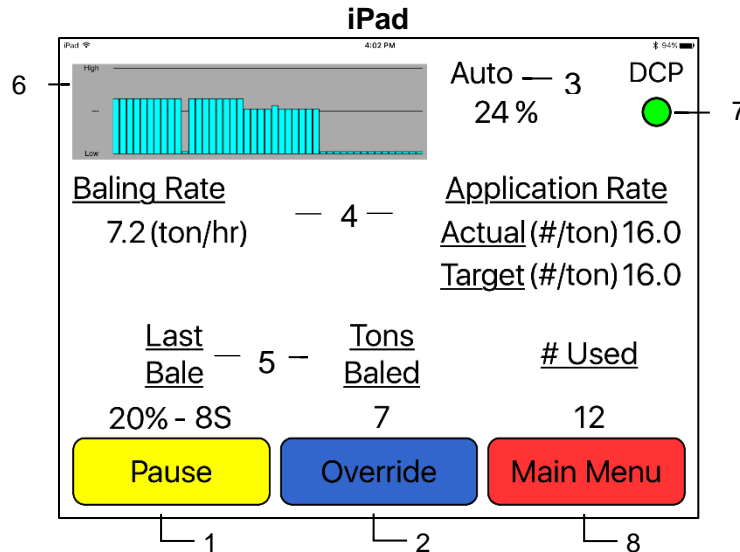

1. To pause the unit while in operation select the Pause key.
2. Push the OVERRIDE key to turn on all three pumps at the same time for full output of the system. Use this mode when going through a short area of wet crop.
3. The moisture content is shown in the upper right hand corner.
4. Baling Rate and Application Rate are shown in the middle of the screen. The operator sets the target application rate and baling rate in the setup mode; the actual rate should be within +/- one pound.
5. Volume used and strokes per bale are shown at the bottom of the screen will show accumulated pounds of preservative used on the go. This number will reset at power down, but remains in the job record screen.
NOTE: Initial start-up requires pressing the New Job key in the Job Records screen in order for Volume Used accumulation to be recorded. This only needs to be done once on initial start-up of system and not every time the system is started for operation. (See JOB RECORDS screen)
6. The graph shows the moisture trend from the past 90 seconds in 3 second intervals.
7. The DCP button shown when using an iPad displays your connection signal with the Bluetooth receiver. Green – DCP is connected, Yellow – DCP is connecting, Red – DCP not connected.
8. Press the MAIN MENU key to return to the opening screen.

Manual Mode

After pushing the MANUAL MODE key in the Main Menu screen, the following screen will appear:

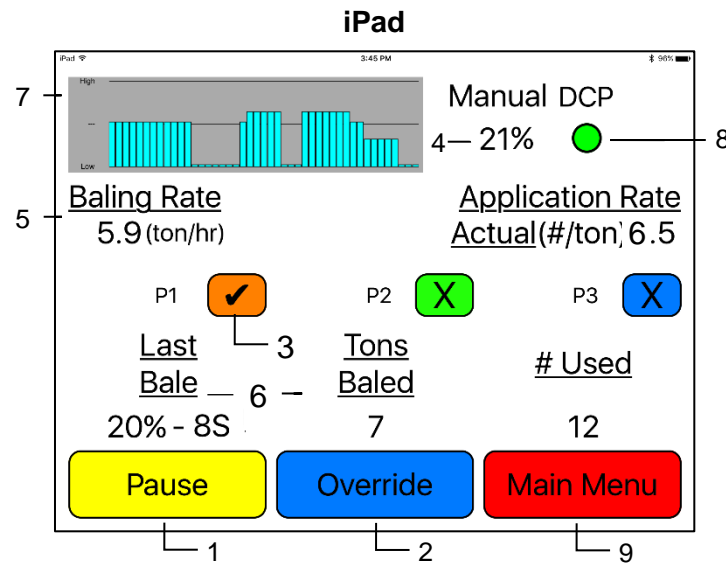

1. To pause the unit during operation select the Pause key.
2. Push the OVERRIDE key to turn on all three pumps at the same time for full output of the system. Use this mode when going through a short area of wet crop.
3. To turn the pump on, select the colored box next to P1 and change the 'X' to a check mark. In Manual Mode (regardless of moisture, baling rate or bale weight) the outputs are fixed rates as follows:

Small Square Balers

Pump	Low Tips Output (Lbs / HR) (L)	High Tips Output (Lbs / HR) (L)
1	25 (11L)	40 (18L)
2	75 (34L)	75 (34L)
3	145 (66L)	205 (93L)

4. The moisture content is shown in the upper right hand corner.
5. Baling rate and Application rate are shown in the middle of the screen. The output of a pump can be checked by dividing the preset output (shown in step 3) by the displayed baling rate. For example, if you have the high output tips in and are running pump 1, by itself, your output is 40 lbs/hr. Given the baling rate shown on the above screen of 5.9 tons/hr, the application rate should be about 6.5 lbs/ton (40 lbs/hr divided by 5.9 tons/hr). The baling rate is set in the SETUP MODE menu.
6. Volume used and strokes per bale shown at the bottom of the screen will show accumulated pounds of preservative used on the go. This number will reset at power down, but remains in the job record screen.
NOTE: Initial start-up requires pressing the New Job key in the Job Records screen in order for Volume Used accumulation to be recorded. This only needs to be done once on initial start-up of system and not every time the system is started.
7. This graph shows the moisture trend from the last 90 seconds of baling (one reading every 3 seconds).
8. The DCP button shown displays your connection signal with the Bluetooth receiver.
Green – DCP is connected, Yellow – DCP is connecting, Red – DCP not connected.
9. Pressing MAIN MENU will return you to the opening screen.

Job Records

After pushing the JOB RECORDS key in the Main Menu screen, the following screen will appear:

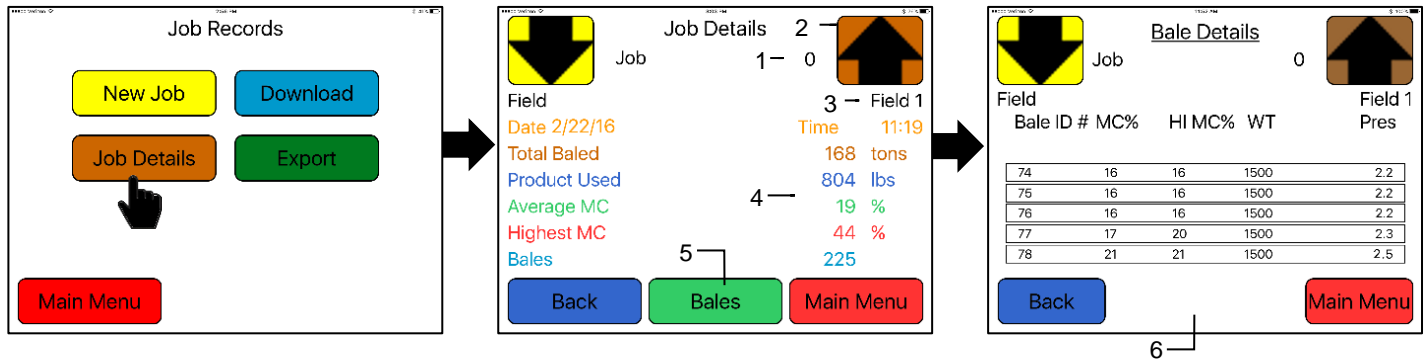

1. The job number will be displayed at the top center. The current job being viewed will always read "Job #: 0". Product used and average moisture content will be reset when the NEW JOB key is pressed. The job records screen will store up to 300 jobs allowing access previous jobs by using the up and down arrows.
2. Scrolling through previous jobs is done by pressing the UP or Down keys.
3. The field name is located under the up arrow.
4. The accumulated information from the field will be displayed in the middle of the screen. **Every time the NEW JOB key is pressed the accumulated pounds on auto and manual modes will be reset to zero.** After 300 jobs have been stored, the next time the NEW JOB key is pressed the system will start over with job one and the old job will be replaced.
5. Selecting the Bales button will open the Bale Details Screen.
6. The Bale Detail screen will display the individual bale information onto each line. Including Bale ID#, MC% (moisture percentage), HI MC% (high moisture percentage), WT (weight of bale) and Pres (preservative used per bale).

NOTE: Initial start-up requires pressing the New Job key in the Job Records screen in order for Volume Used accumulation to be recorded. This only needs to be done once on initial start-up of system and not every time the system is started for operation.

Download Job Records

After pushing the JOB RECORDS key in the Main Menu screen, the following screen will appear:

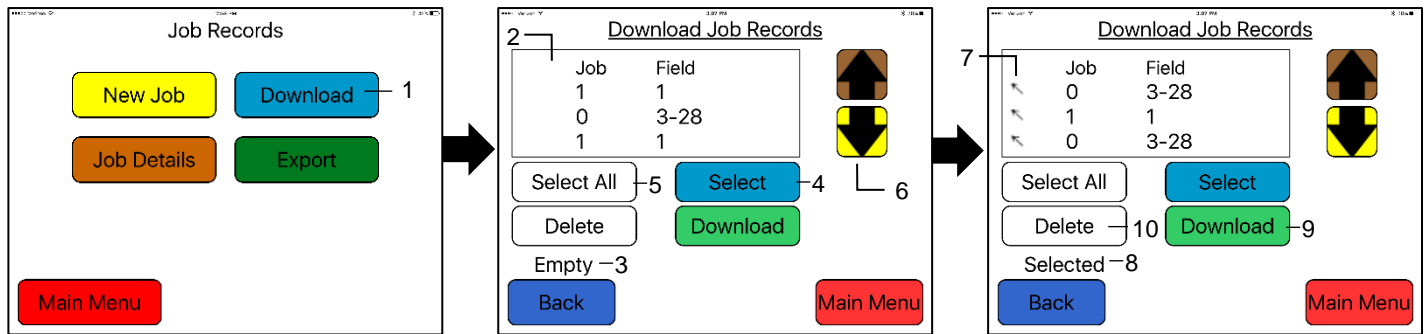

Prior to downloading job records a USB stick will need to be placed into the USB port on the applicator's Dual Channel Processor (DCP). Jobs will not be downloaded if the USB stick is plugged into the monitor.

1. To download the Job Records to a USB stick, select the Download button
2. The list of job records you have created, will display in the middle of the screen
3. When no jobs have been selected the status line will read Empty
4. To download individual job(s), tap the desired job(s) to be downloaded, or press the Select button
5. To select all of the jobs stored, press the Select All Button
6. Move through job records by selecting the up or down arrows
7. The  indicates selected jobs to be downloaded
8. When chosen jobs have been selected the status line will read Selected
9. Press Download button to download job records to USB Stick. The status line will read Downloading
10. Delete selected jobs by pressing the Delete button

Export Job Records (emailing records)

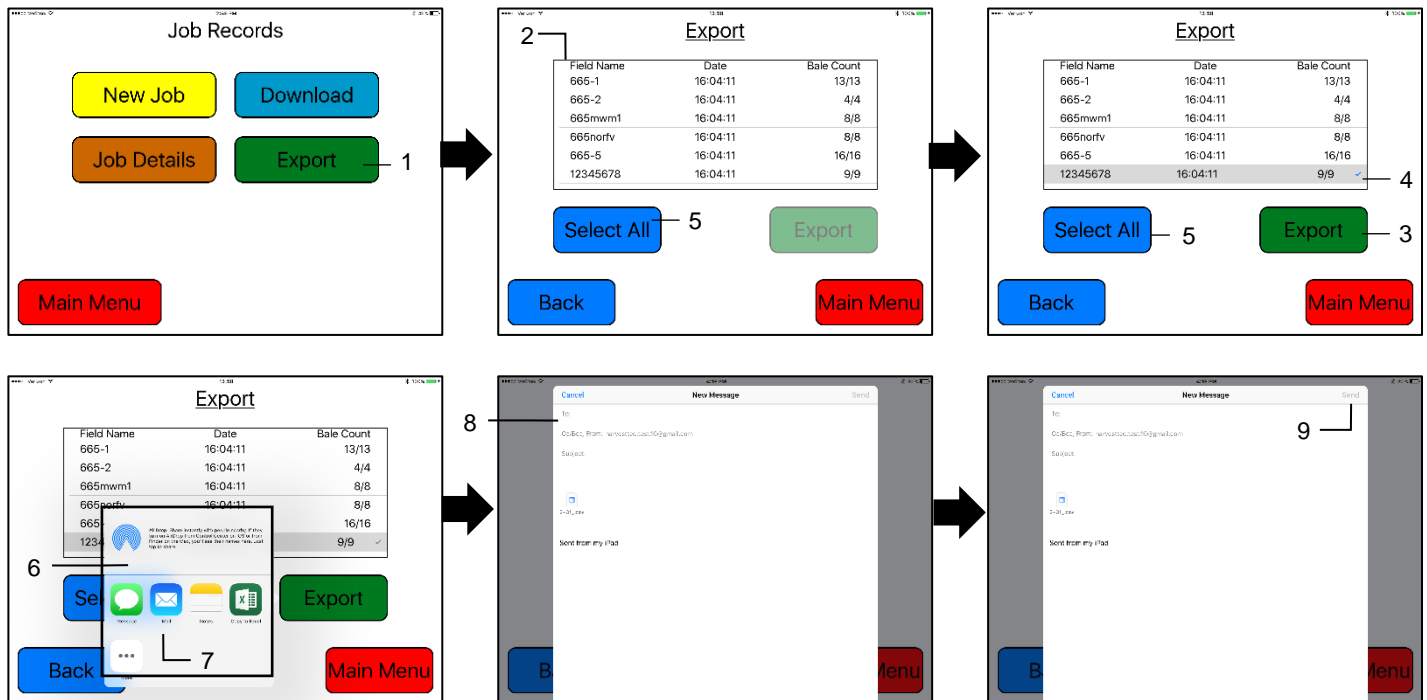

- To export the Job Records through an email or save to the iPad select the Export button
- The list of job records you have created, will display in the middle of the screen and the individual bale information will begin to download automatically. The number of bales will grow until equal to the number of bales available to export for each job record.
 - For example: When looking at a job record with 62 bales, the bale count will read 0/62 upon initially opening the page. The number will increase until it reads 62/62.
- When all bales have been retrieved, the Export tab will become active
- To export individual job(s), tap the desired job(s) to be exported. The ✓ indicated chosen job(s).
- To select all of the jobs stored to be export, press the Select All Button
- After selecting the Export tab, a small screen will appear with the mail app icon.
 - If selecting two or more jobs the email will automatically appear (skipping step 7)
- Select the Mail app to open
- Enter in the desired email address in the (To:) line of the email that will appear. Press the send button to email the file to the email you have entered.

Export Job Records (saving to iPad)

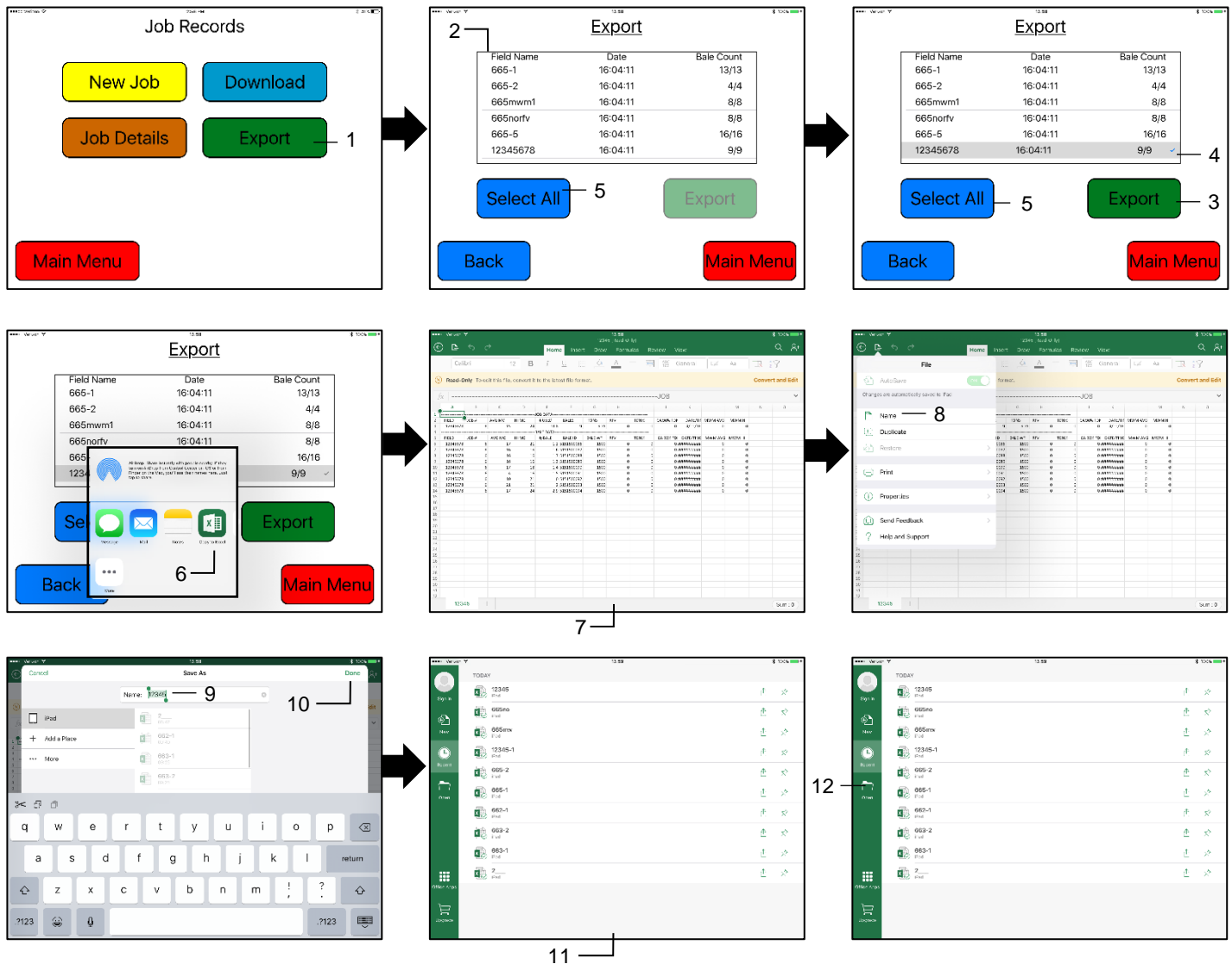

1. To export the Job Records through an email or save to the iPad select the Export button
2. The list of job records you have created, will display in the middle of the screen and the individual bale information will begin to download automatically. The number of bales will grow until equal to the number of bales available to export for each job record.
 - a. For example: When looking at a job record with 62 bales, the bale count will read 0/62 upon initially opening the page. The number will increase until it reads 62/62.
3. When all bales have been retrieved, the Export tab will become active
4. To export individual job(s), tap the desired job(s) to be exported. The ✓ indicated chosen job(s).
5. To select all of the jobs stored to be export, press the Select All Button
6. After selecting the Export tab, a small screen will appear with the Excel app icon.
 - a. It is recommended to download the Excel App to properly view the job records
 - i. Only one job can be selected at a time to view on iPad
7. After the Excel app has been selected the job record spreadsheet will open
 - a. The iPad can only view one job at a time
8. To save the job, select Name from the drop down tab
9. Enter your desired file name
10. Press the save button after entering your file name
11. The list of saved files will appear
12. You can also view the files by selecting the Open tab, when opening the Excel app

Wiring Diagram

1. Connect the tractor Power / Communication (006-6650TM(E)) to the battery. The red power wire with the 50 amp fuse to the positive side (12 volt) of the battery. Connect the black ground wire to frame of tractor or negative side.
 - a. The power harness must be connected to the battery! The unit will draw more amps than convenience outlets can handle. Any modifications of the power harness will void systems warranty. **IF MODIFICATIONS ARE REQUIRED CONTACT HARVEST TEC FIRST!**
 - b. This unit will not function on positive ground tractors.
2. Connect Pump Controller Harness (006-5650FC* or 006-5650F2M*) to DCP & Pump Controller (006-5672)
 - a. Connect Pump Harness (006-4660Z) and Flow Meter (006-4725A) to pump controller
3. Connect Moisture / Bale Rate Harness (006-7303H) to DCP.
4. Connect iPad Integration Control (030-6672C) to the Communication Harness (006-6650TM).
5. Connect the orange wires and attach the plug to the tractor's ISOBUS port.

**Pump Control Harnesses 650 & 645 Models – 006-5650FC | 651 Model – 006-5650F2M*

SYSTEM WIRING DIAGRAM

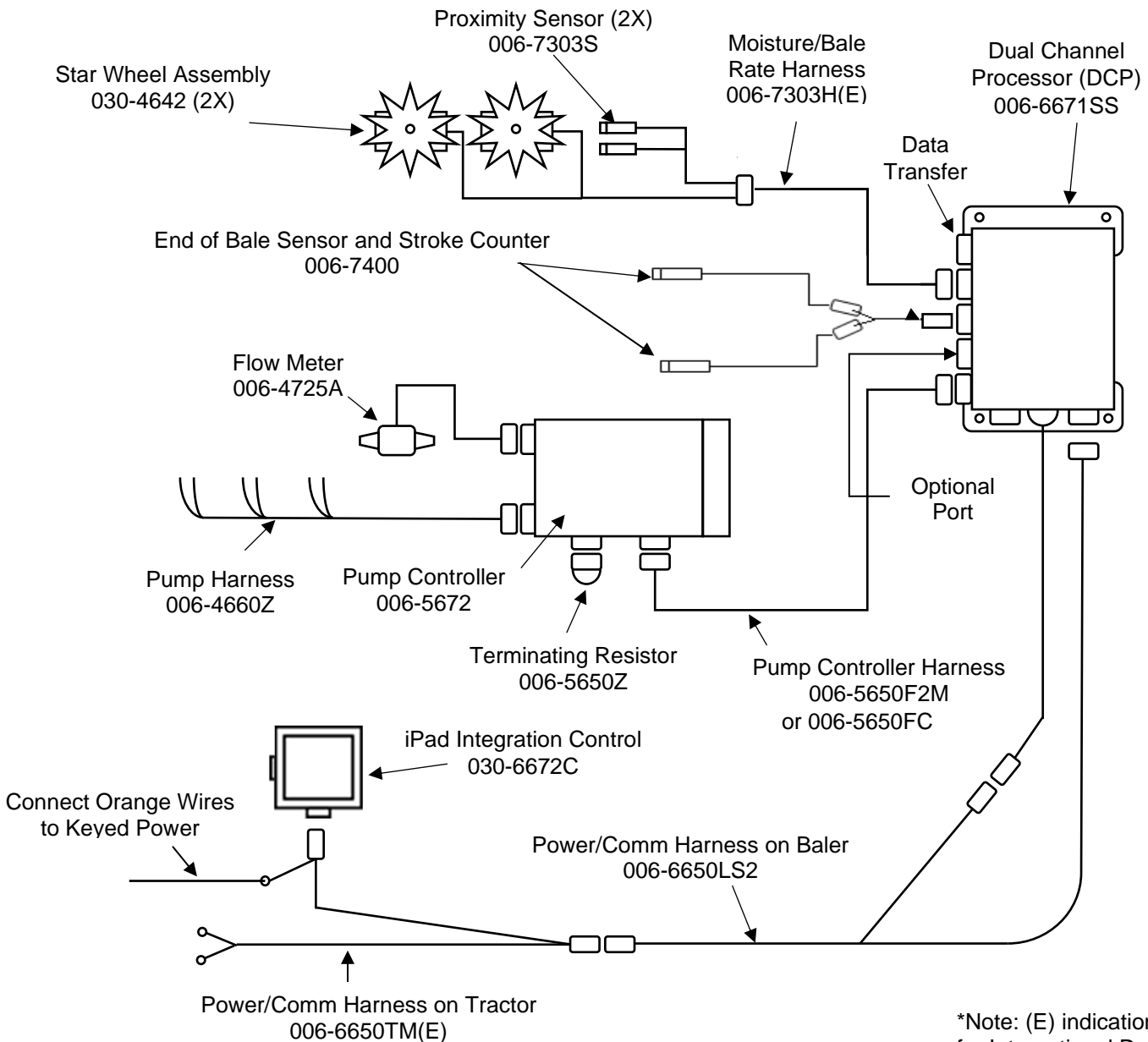

Common Questions

1. How do I turn the system on/off?

Turn the key in the tractor to the on position. If the unit is in Standby Mode, press anywhere on the screen. To turn off, press the Standby key, wait for the screen to power down and turn off the key.

2. How to get in the LBS/TON, MC%, and TONS/HR menus?

In the Main Menu press the SETUP MODE key. From this screen you can change your application rates and how much product is applied. See SETTING UP FOR INITIAL USE for a detailed explanation of this process.

3. The unit is stuck in the MC% screen.

In the MC% screen, level 1 must be less than level 2, and level 2 must be less than level 3. For example, if level 1 is set at 16, level 2 must be set at 17 or higher, and level 3 must be set higher than level 2.

4. How does OVERRIDE work?

Override turns on all three pumps at full output. The pumps will remain at full output until the operator turns these pumps off by pressing the OVERRIDE key again.

5. The flow meter reading is more or less than the programmed level set in the box.

Some variation in flow meter readings compared to the programmed set point is normal due to factory tolerances on the pump motors as well as varying tractor voltages inputted to the control box. The flow meter reading is an accurate measure of how much product is actually being applied. The set points then will need to be adjusted if you want to attain a different flow meter reading.

6. Why don't all the pumps turn on even at higher application rates?

The selections of what pumps turn on when are automatically controlled by the control box's flow rate look up chart. Thus, not all the pumps turn on at once and the combination of what pumps turn on when is automatically controlled by the software. If you want to make sure all three pumps are working, go to the Diagnostics screen and run pump outputs.

7. The moisture content displays "LO" or "HI" all the time.

When the moisture content display does not change frequently while baling, there is likely a faulty star wheel connection. One of the first places to check is inside the white star wheel block. Check to see if the electronic swivel is in the star wheel shaft and check to see that the star wheel shaft is not working out of the block. Also, check all star wheel wires and connectors to see if there is a continuity or grounding problem.

8. Should the battery connections be removed before jump starting or charging a battery?

Yes. Anytime the tractor will have voltage going up rapidly the connections should be removed.

9. How do I recalibrate the touch screen display?

In the system diagnostics screen press the Recalibrate Touch screen key and follow the directions on the screen. Press accept when done.

10. How can I turn the optional Hay Indicators on/off from the cab?

In the Setup Mode screen press options. Press the on/off underlined area next to EOR sensor.

11. What do the lights on the 030-6672B indicate?

Pre-2020 applicators were equipped Bluetooth receivers (030-6672B) and are now equipped with lights to indicate both power and Hay App connection on the Apple iPad. Red Light – The Bluetooth receiver has power. Green Light – The Bluetooth receiver is connected to the Hay App

Troubleshooting

PROBLEM	POSSIBLE CAUSE	SOLUTION
Moisture reading errors (high or low)	1. Wire disconnected or bad connection between star wheels and DCP	1. Reconnect wire.
	2. Low power supply to DCP	2. Check voltage at box. Min of 12V
	3. Wet hay over 32% moisture	
	4. Ground contact with one or both star wheels and baler mounted processor.	4. Reconnect.
	5. Short in wire between star wheels and DCP.	5. Replace wire.
	6. Check with hand tester	6. Contact Harvest Tec if no change
Moisture readings erratic.	1. Test bales with hand tester to verify that cab monitor has more variation than hand tester.	
	2. Check all wiring connections for corrosion or poor contact.	2. Apply dielectric grease to all connections.
	3. Check power supply at tractor. Voltage should be constant between 12V and 14V	3. Install voltage surge protection on tractors alternator.
Terminal reads under or over power.	1. Verify with multi-meter actual voltage. Voltage range should be between 12-14 volts.	1. Clean connections and make sure applicator is hooked to battery.
Bale rate displays zero.	1. Bale rate sensors reversed. 2. Short in cable. 3. Damaged sensor.	1. Switch the sensors next to the star wheel. 2. Replace cable, Replace sensor.
Display will not power up.	1. Connection broke between the display and the DCP. 2. Short in display cable.	1. Check, clean, and tighten connections. 2. Replace cable.
Display is too dark or light	1. Change in temp or light	1. Use the monitors contrast control.
Display is locked up/froze.	1. CAN communication not responding. 2. Broke connection between the display and DCP.	1. Check connections at DCP and Pump controller including the terminating res. 2. Check, clean, and tighten. 3. Power unit down and restart after steps 1 & 2 are complete.
Display powers up when key is turned and will not go to the Main Menu screen.	1. CAN communication not responding. 2. Broke connection between the display and DCP.	1. Check connections at DCP and Pump controller including the terminating res. 2. Check, clean, and tighten. 3. Power unit down and restart after steps 1 & 2 are complete.
Display is locked up/froze and pumps continue to run.	1. CAN communication not responding. 2. Broke connection between the display and DCP.	1. Check connections at DCP and Pump controller including the terminating res. 2. Check, clean, and tighten. 3. Power unit down and restart after steps 1 & 2 are complete.
System does not pause at end of row when using 474A crop eyes.	1. Short in cable. 2. Damaged sensor. 3. Bad alignment of sensors	1. Replace cable. 2. Replace sensor 3. Check 474 manual for alignment instructions
Bale rate displays zero.	1. Bale rate sensors are reversed. 2. Short in cable. 3. Damaged sensor.	1. Switch the sensors next to the star wheel. 2. Replace cable. 3. Replace sensor.

Display says PAC error	<ol style="list-style-type: none"> 1. The DCP and Pump controller are not communicating. 2. Broke connection between the display and DCP or Pump control and DCP. 	<ol style="list-style-type: none"> 1. Check all connections at DCP and Pump controller including terminating resistors. 2. Check, clean, and tighten connections.
Can't select moisture / preservative information on baler run screen	DCP not selected in baler software	Select DCP for the moisture option in machine setup. See Communicating through ISOBUS Monitor section in operation manual
'?' or '---' for moisture values are being shown on baler run screen	CNH software must see a stuffer cycle before it will update the moisture values	Simulate a stuffer cycle on baler, or wait until baling in the field and the moisture will update
Job records are showing as symbols or incorrect values	The job file is corrupted on SD card	Write down all job record information the operator wishes to keep. Update the DCP software to the most current version available on the Harvest Tec website. Delete all existing jobs by selecting all in the download screen and pressing delete. Be sure to start a new job and verify it is saved by checking job details screen.
Values in auto / manual mode are obscure	The job file is corrupted on SD card	System needs to be sent to Harvest Tec for repair.
Can't download job records, stuck at "Saving to USB Stick"	One of more jobs are corrupted on SD card. If "saving to USB" is displayed, some jobs have been downloaded correctly.	
Bale rate goes to zero and prox sensors/star wheels check out fine	DCP is set to use "Bale Rate Sensor" from baler in calculation and baler does not have this option installed	Turn off Bale Rate Sensor in baler sensors screen, make sure Auto baling rate is turned on in baling rate setup screen
Bluetooth Receiver lights will not illuminate	<ol style="list-style-type: none"> 1. Bluetooth receiver not connected 2. Harness disconnected 3. Low power 	<ol style="list-style-type: none"> 1. Check connections and voltage. Minimum 12.5V needed.
	<p><i>Blinking Lights</i> – System is waiting for the processor to connect, which could take up to 35 seconds.</p> <p><i>Red Light</i> – The Bluetooth receiver has power</p> <p><i>Green Light</i> – When the proper active connection is selected in the Hay App menu, the green light will indicate connection with the iPad.</p>	

iPad Troubleshooting

iPad Symptom	Troubleshooting
iPad won't turn on	- Turn your iPad off and on. Press and hold the Sleep/Wake button for a few seconds until a red slider appears; then slide it. Press and hold the Sleep/Wake button to turn on again.
	-Reset your iPad. Press the "Sleep/Wake" button and the "Home" button simultaneously for at least 10 seconds until the Apple logo appears on the screen. This reset will not damage your files.
	You may have a drained battery. Plug your iPad into your computer or AC adapter and see if anything happens. Ideally your iPad will recognize it has been connected to a power source and charge its battery. If it will no longer charge, the battery must be swapped with a replacement battery. Battery level is display in top right corner of iPad.
iPad won't connect to Bluetooth accessory	-Make sure that your Bluetooth accessory and iOS device are close to each other when connecting.
	-Make sure that your Bluetooth accessory is on and fully charged or connected to power. If it uses batteries, test them to see if they need to be replaced.
	-Restart your Bluetooth receiver, by removing power and reconnecting after 30 seconds.
	-Make sure that you have at least a 3 rd generation iPad with iOS8 or greater operating system on your iPad
	-On your iPad, go to Settings > Bluetooth and make sure that Bluetooth is on. If you can't turn Bluetooth on or you see a spinning gear, restart your iPad
	-Unpair the Bluetooth accessory, put the accessory back in discovery mode, then pair and connect it again. By tapping on its name in the Bluetooth accessories tab and then Forget this Device. In settings, tap on a device's name, then Unpair.
iPad touchscreen is slow or does not respond	-It may be that your screen is dirty. Try cleaning your screen. To do this, unplug everything, turn off iPad then with a very soft, lint-free and slightly damp cloth gently wipe the screen. Do NOT use window cleaners.
	-If you have any screen protector sheet, try removing it.
iPad is not charging or is slow to charge	-In order to charge your iPad you can try either connecting your iPad to a power outlet or connecting to a USB 2.0 port on a computer. However, note that computers generally don't supply enough power to their USB ports to be able to charge an iPad. When this happens, a "Not Charging" message will appear.
How can I unlock my iPad if I forgot the passcode	If you cannot remember the passcode, you will need to <i>restore your device using the computer with which you last synced it</i> . This allows you to reset your passcode and resync the data from the device (or restore from a backup). If you restore on a different computer that was never synced with the device, you will be able to unlock the device for use and remove the passcode, but your <i>data will not be present</i> .
How do I send in my iPad for service?	Refer to your iPad owner's manual or contact apple customer service. DO NOT SEND iPad TO HARVEST TEC.
For other issues refer to your iPad Owner's Manual or contact Apple Directly	

***Harvest Tec Does Not Service iPads ***

Maintenance

1. Clean the tip strainers and main strainer every 10 hours of operation or more frequently if required.
2. Depending on the product being used, the system may need to be flushed with water at a regular interval (consult with manufacturer of the chemical). If Harvest Tec product is being used, flushing is not necessary.
3. Although the pump can run dry, extended operation of a dry pump will increase wear. Watch the preservative level in the tank.
4. Cover the automatic cab terminal on open station tractors if left outside.
5. Pump performance may start to decline after 400 hours (1500 acres on conventional balers) of use. Rebuilding pumps is a simple procedure if the motor is not damaged. Order pump rebuilding kit #007-4581 for the automatic unit.
6. If you are using bacterial inoculants, flush your system daily after every use.
7. Clean tank cap every 10 hours of operation.

Maintenance Schedule

	Daily	10 hrs	400 hrs	Weekly	Monthly	Season
Diagnostics	X					X
Filter bowl cleaning		X				X
Tip screen cleaning		X				X
Tank cap cleaning		X				X
Dielectric grease connections					X	X
Rebuild pump			X			
Battery connections				X		X
Check valves			X			
Visually inspect hoses				X		X

Winter Storage

1. Thoroughly flush the system with water.
2. Remove the filter bowl and run dry until the water has cleared out of the intake side.
3. Remove red plug from bottom of the pump, drain, and run the pump for 30 seconds or until it is dry.
4. Drain all lines on the outlet side.
5. Never use oils or alcohol based anti-freeze in the system.
6. During spring start-up, if the pump is frozen turn off the power immediately to avoid burning the motor out. The pump head can be disassembled and freed or rebuilt in most cases.
7. Disconnect power from system.
8. Remove display from tractor and store in a warm dry place.

Status Alerts

Two Status Alerts will appear on the Auto and Manual mode screens when the Job Records are approaching, or full of records.

Status Alert "**Bale Records: Less than 1K remaining**". The system is now approaching the maximum amount of records that can be saved. When this code appears download and delete jobs in the Job Records menu. Follow the instructions in Job Records to accomplish this.

Status Alert "**Bale Records failed – Memory Full**". The system will no longer accept any new data until jobs in the Job Records menu are downloaded and deleted. Follow the instructions in Job Records to accomplish this.

Pin Outs

A. Communication and power harness

Pin 1	Red	Can 12 volt
Pin 2	Red	Battery 12 volt
Pin 3	Orange	Keyed power
Pin 4	Not Used	
Pin 5	Yellow	Comm channel OL
Pin 6	Green	Comm channel OH
Pin 7	Not used	
Pin 8	Black	Can ground
Pin 9	Black	Battery ground
Pin 10	Not used	

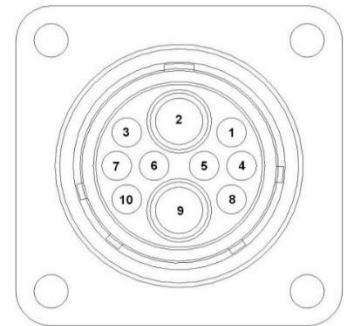

B. Main power connector mounted on DCP

Pin 1	Red	+ 12 V input from tractor supply
Pin 2	Black	Ground from tractor supply
Pin 3	Orange	Keyed power

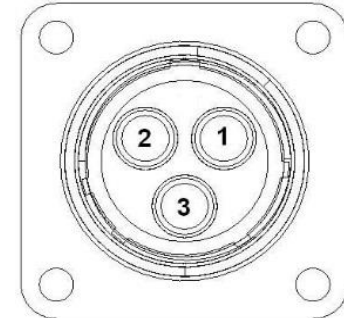

C. Pump connection colors

Pin 1	Black with orange markings	Pump 1 ground
Pin 2	Black with green markings	Pump 2 ground
Pin 3	Black with yellow markings	Pump 3 ground
Pin 4	Not used	
Pin 5	Orange with black markings	Pump 1 positive
Pin 6	Green with black markings	Pump 2 positive
Pin 7	Yellow with black markings	Pump 3 positive

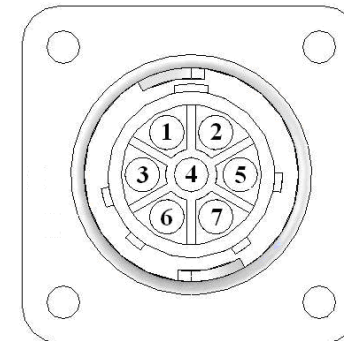

D. Flow meter connection on Pump Controller

Pin 1	White	5 - 12 V (+) supply
Pin 2	Green	Ground
Pin 3	Brown	Signal
Pin 4	Black	Shield

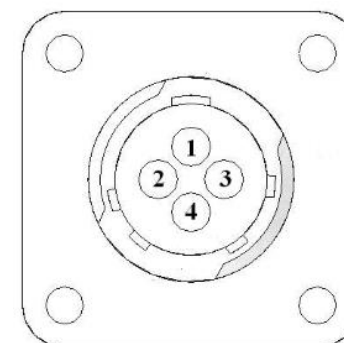

E. Connector for Hay Indicator option on DCP

Note: Hay indicators are an option that will turn the system on and off automatically as hay enters the pickup of the baler.

Pin 1	Red	+12V
Pin 2	Black	Ground
Pin 3	White	Signal wire
Pin 4	Not used	

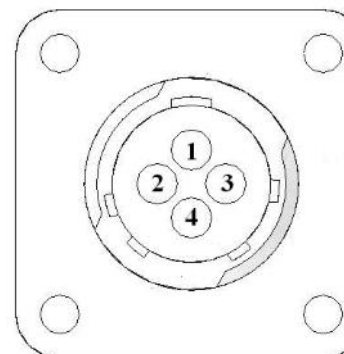

Pin Outs (continued)

F. End of bale sensor on DCP

Pin1	Brown	<u>Sensor power</u>
Pin2	Blue	Sensor ground
Pin3	Not used	
Pin4	Black	Signal from sensor

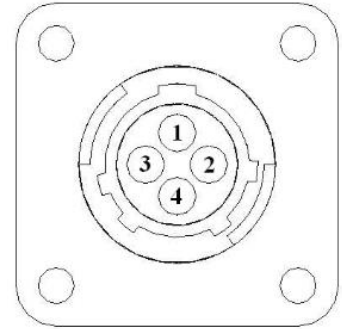

G. Moisture and Bale rate sensor connector on DCP

Pin 1	Not used	
Pin 2	Not used	
Pin 3	Not used	
Pin 4	Not used	
Pin 5	Silver	Shield
Pin 6	Silver	Shield
Pin 7	Not used	
Pin 8	Violet	Moisture input 1
Pin 9	Brown	Moisture input 2

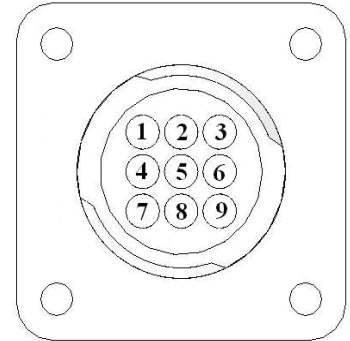

H. Communication harness on DCP

Pin 1	Orange	Power to display
Pin 2	Blue	Ground to display
Pin 3	Green	Comm channel OH
Pin 4	Not used	
Pin 5	Yellow	Comm channel OL
Pin 6	Not used	
Pin 7	Not used	

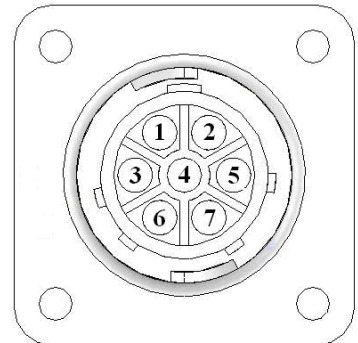

I. Communication harness on DCP and Pump Controller

Pin 1	Red	Can 12 volt
Pin 2	Red	Battery 12 volt
Pin 3	Grey	Shield
Pin 4	Green	Comm channel OH
Pin 5	Yellow	Comm channel OL
Pin 6	Blue	Comm channel IH
Pin 7	Orange	Comm channel IL
Pin 8	Black	Can ground
Pin 9	Black	Battery ground
Pin 10	Not used	

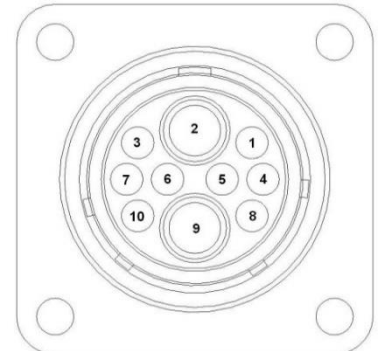

ISOBUS Plug Tractor Side

Pin 1	N/A
Pin 2	N/A
Pin 3	+12V Keyed Tractor Power
Pin 4	N/A
Pin 5	N/A
Pin 6	N/A
Pin 7	N/A

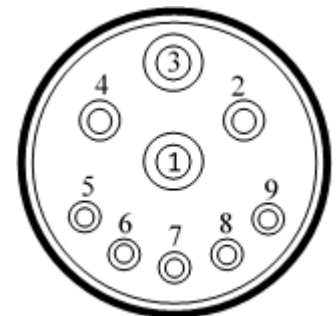

Parts Breakdown

Model 644 Base Kit



<u>Ref#</u>	<u>Description</u>	<u>Part #</u>	<u>Qty</u>	<u>Ref#</u>	<u>Description</u>	<u>Part #</u>	<u>Qty</u>
1	Tank	005-9203SQ	1	4	Tank Saddle	001-4703X	1
2	Tank lid	005-9022H	1	5	Tank fitting	005-9100	2
3	Tank straps	001-4402	2	6	Pump Plate Mount	001-4647	1

Model 645 Base Kit

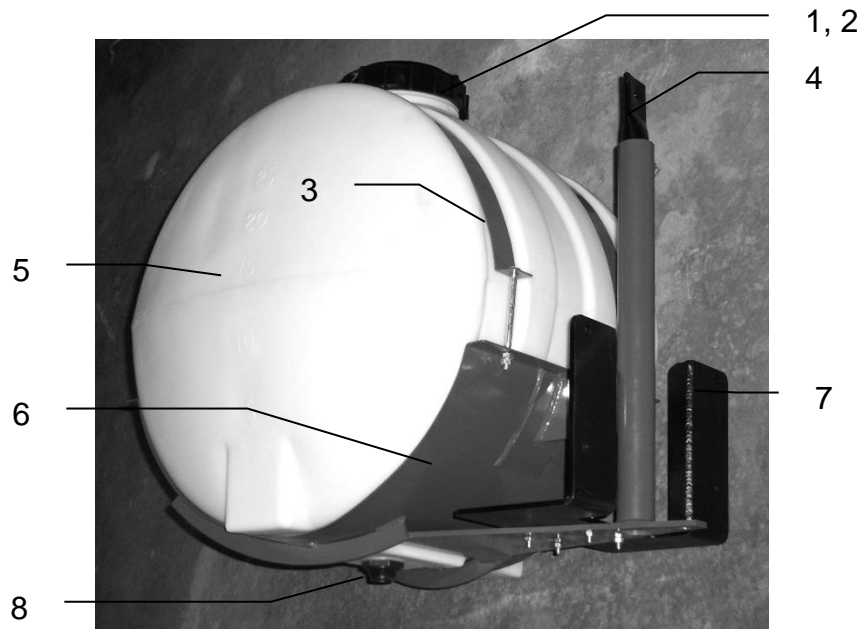

<u>Ref#</u>	<u>Description</u>	<u>Part #</u>	<u>Qty</u>	<u>Ref#</u>	<u>Description</u>	<u>Part #</u>	<u>Qty</u>
1	Tank Cap	005-9022C	1	5	Tank	005-9022	1
2	Tank Cap Gasket	005-9022CG	1	6	Saddle	001-4401	1
3	Tank Strap	001-4402	2	7	Mounting Bracket	001-4647	1
4	Stub Pipe	001-4403	1	8	Tank Fitting	005-9100	1

Harvest Tec Model 650 Base Kit

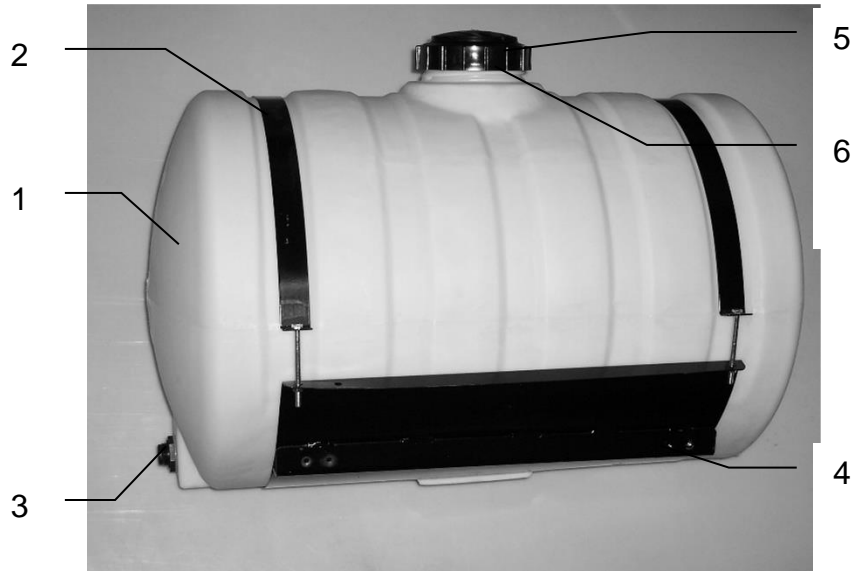

<u>Ref#</u>	<u>Description</u>	<u>Part #</u>	<u>Qty</u>	<u>Ref#</u>	<u>Description</u>	<u>Part #</u>	<u>Qty</u>
1	Tank	005-9203	1	4	Saddle	001-4703	1
2	Straps	001-4402	2	5	Tank Cap	002-9022C	1
3	Tank Fitting	005-9100	2	6	Tank Gasket	002-9022CG	1
				NP	DCP mount	001-4703BPM	2

Model 651 Base Kit

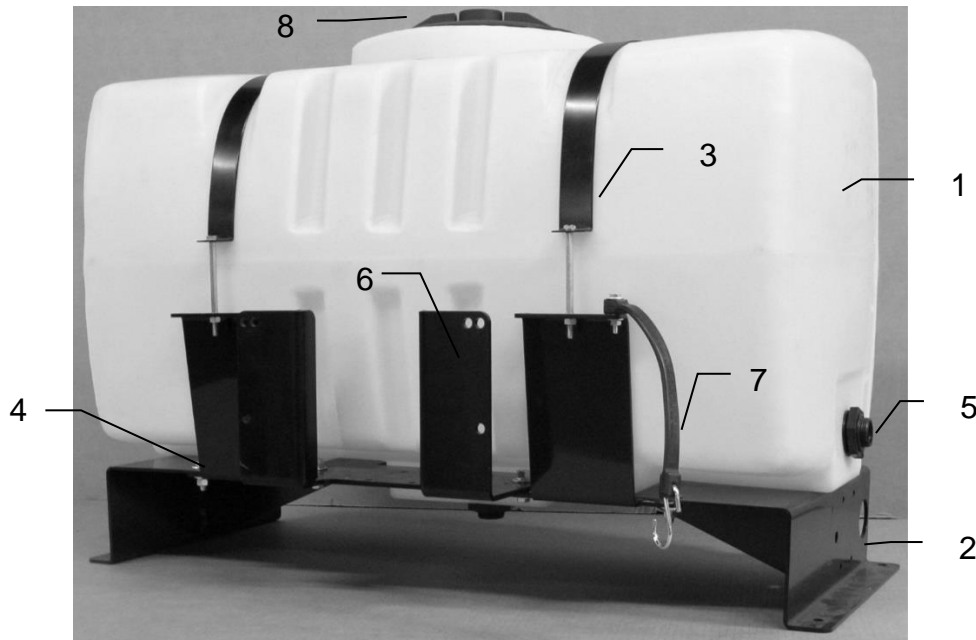

<u>Ref#</u>	<u>Description</u>	<u>Part #</u>	<u>Qty</u>	<u>Ref#</u>	<u>Description</u>	<u>Part #</u>	<u>Qty</u>
1	Tank	005-9203SQ	1	6	Mounting Bracket	001-4647	1
2	Tank Saddle	001-4703C	1	7	Door Latch	001-4703CL	1
3	Tank Straps	001-4402	2	8	Tank Lid	005-9022H	1
4	Short Strap Base	001-4703CC	2	NP	Long Strap Base	001-4703CD	2
5	Tank fitting	005-9100	2	NP	Not Pictured		

Parts Breakdown for Pump Manifold

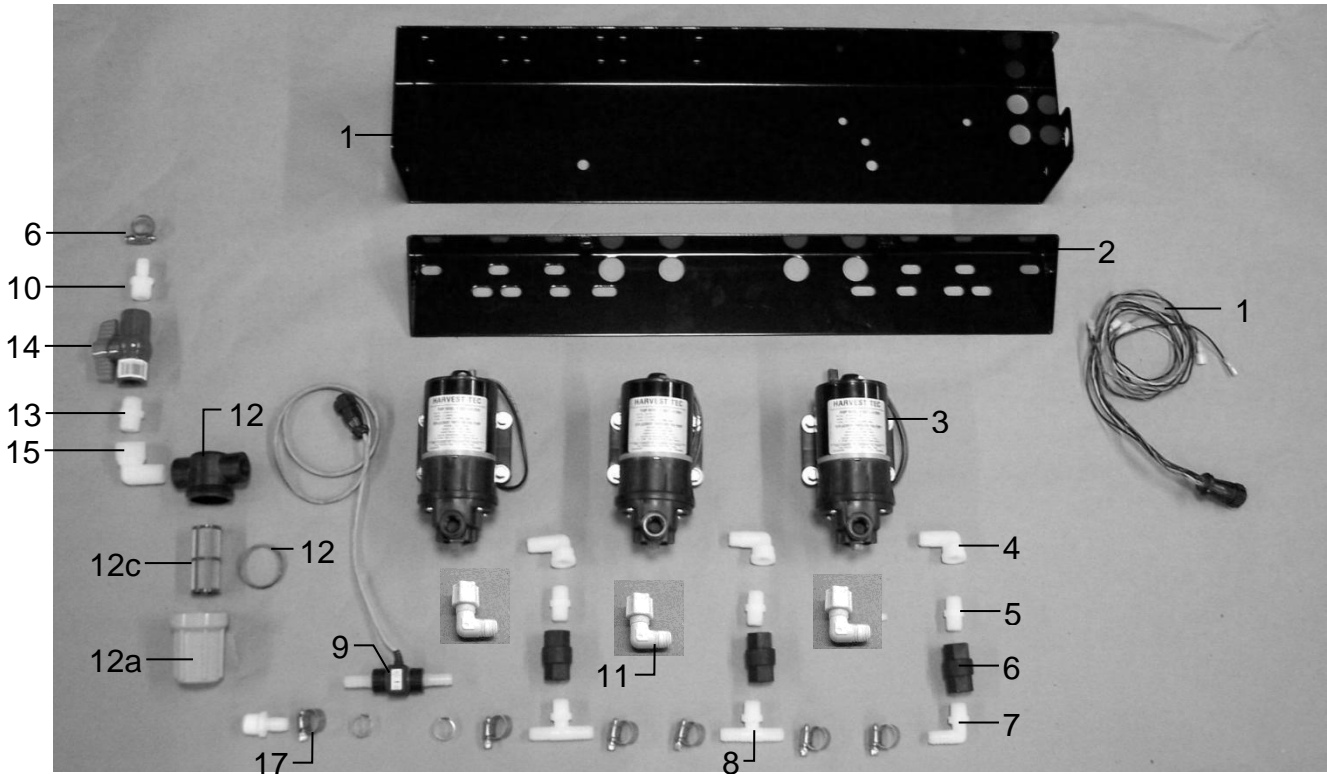

<u>Ref#</u>	<u>Description</u>	<u>Part#</u>	<u>Qty</u>
1	Pump plate	001-4646D	1
2	Mounting Bracket	001-4646C	1
3	Pump	007-4120H	3
4	Street elbow fitting	003-SE38	3
5	Nipple fitting	003-M3838	3
6	Check valve	002-4566F	3
7	Elbow fitting	003-EL3812	1
8	Tee fitting	003-T3812HB	2
9	Flow meter assembly	006-4725A	1
10	Straight fitting	003-A1212	2
11	Jaco fitting	003-JEL1238	3
12	Filter bowl assembly	002-4315-100	1
12a	Filter bowl only	002-4315F	1
12b	Filter bowl gasket	002-4315D	1
12c	Filter bowl screen	002-4315A	1
13	Nipple fitting	003-M1212	1
14	Ball valve	002-2212	1
15	Street elbow fitting	003-SE12	1
16	Hose clamp	003-9003	7
17	Hose clamp (Flow Meter)	003-9005	2
18	Pump Cable	006-4660Z	1
NP	Elbow	003-EL1212	1
NP	Pump rebuild kit (1 per pump)	007-4581	1
	Complete Pump Assembly	030-4646	

Parts Breakdown for Star Wheels, Bale Rate Sensor, and Hoses

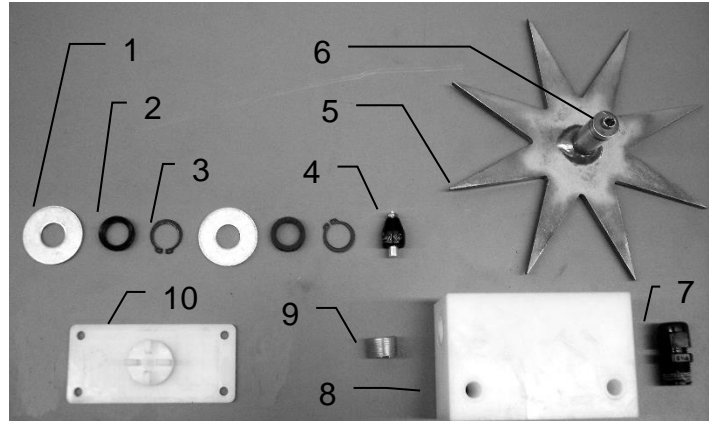
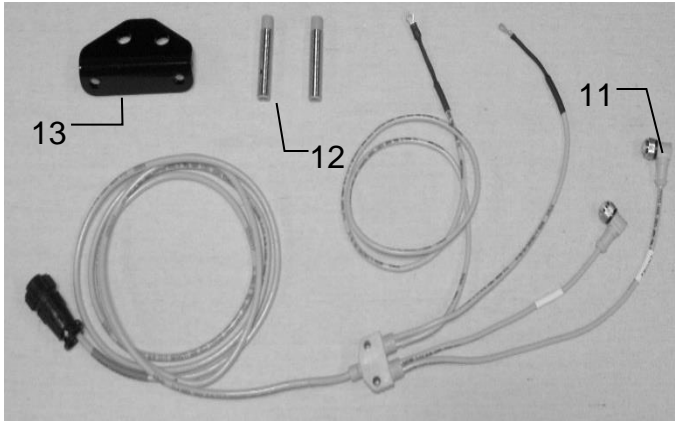

Ref	Description	Part#	Qty
1	Washer (per side)	006-4642K	2
2	Dust Seal (per side)	w/006-4642K	1
3	Snap Ring (per side)	w/006-4642K	2
4	Swivel	006-4642A	2
5	Star Wheel	030-4641E	2
6	Insert	w/ Ref # 5	2
7	Wiring grommet	008-0821A	2
8	Star wheel block	006-4641D	2
9	Plug Fitting	003-F38	2
10	Block Cover	006-4641B	2
1-10	Star wheel assembly	030-4642	2

Ref	Description	Part#	Qty
11	Bale rate & moisture cable	006-7303HS	1
12	Bale rate sensor	006-7303S	2
13	Bale rate sensor holder	001-4644SS	1

Drain / Fill Kit

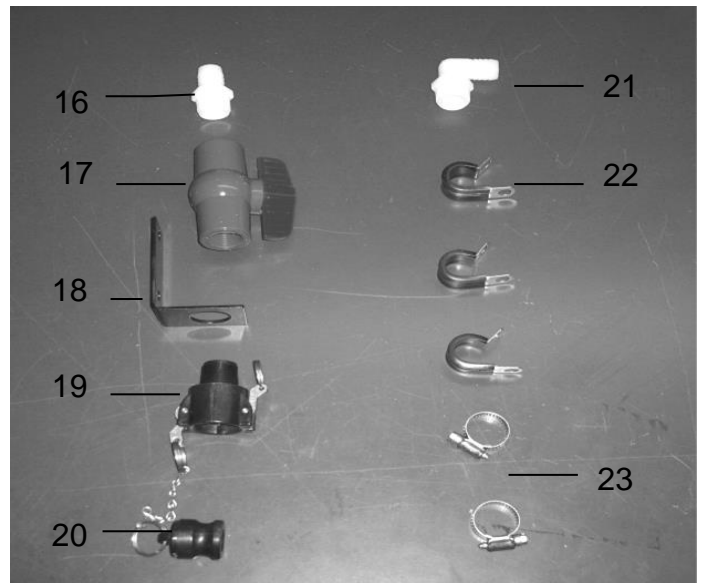

Hose Assembly

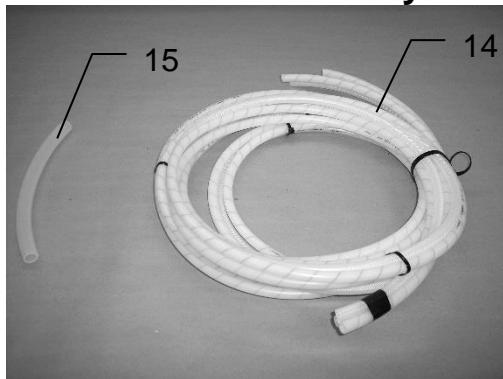

Ref	Description	Part#	Qty
14	Triple weld hose (pumps to tips)	002-9016	15ft
		002-9016B	15ft
		002-9016G	15ft
	Hose assembly (3 hose assembly)	030-9016SS	1
15	1/2" Hose (tank to filter)	002-9001	6ft

Ref #	Description	Part #	Qty
16	Straight Fitting	003-A3434	1
17	Ball valve	002-2200	1
18	Valve Holder	001-6702H	1
19	Female Coupler	002-2204A	1
20	Male Coupler	002-2205G	1
21	Elbow	003-EL3434	1
22	Jiffy Clip	008-9010	3
23	Hose Clamps	003-9004	2
NP	3/4" Hose	002-9002	8ft

Control Boxes and Wiring Harnesses

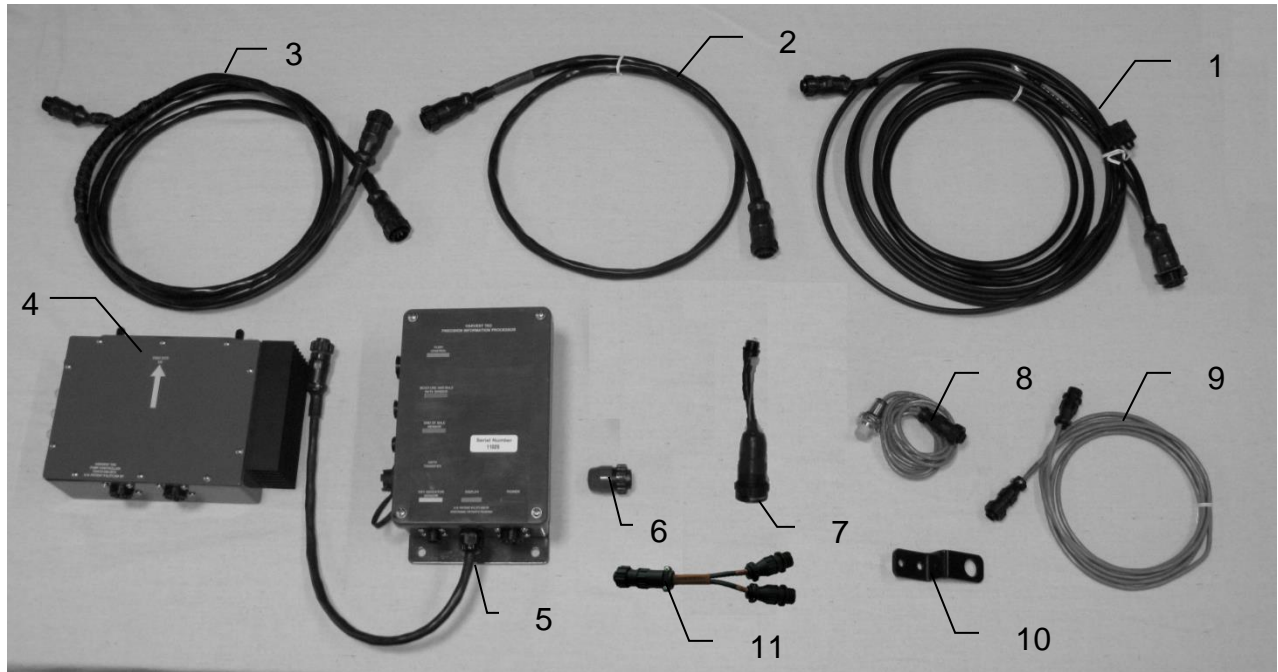

<u>Ref</u>	<u>Description</u>	<u>Part#</u>	<u>Qty</u>
1	Power & communication tractor	006-6650TM	1
2	Pump controller harness (650 & 645)	006-5650FC	1
	Pump controller harness (651)	006-5650F2M	1
3	Power & communication baler	006-6650LS2	1
4	Pump controller	006-5672	1
5	Dual Channel Processor (DCP)	006-6671SS	1
6	Terminating resistor	006-5650Z	1
7	Optional ISOBUS Tractor Plug (not included)	006-6670A	1
8	Bale rate timer	006-7400	2
9	Bale rate timer sensor extension	006-7400EXT	1
10	End of bale bracket (645 & 650)	001-4648SS	1
11	Y Splitter for Prox Sensors	006-7400Y	1
12	iPad Integration Control	030-6672C	1
NP	End of bale bracket (651)	001-4648SC	1
NP	Stroke counter bracket (645 & 650)	001-4648RB	1
NP	Stroke counter bracket (651)	001-4648SI	1
NP	Key switch wire	006-5650K	1
NP	Dust plug kit	006-5651PLUGS	1
NP	USB Cable	006-6672USBC	1

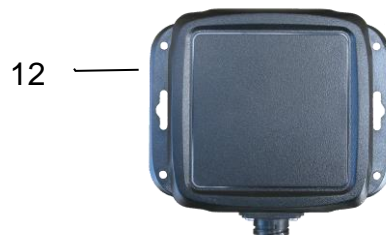

Model 4410B Installation Kit

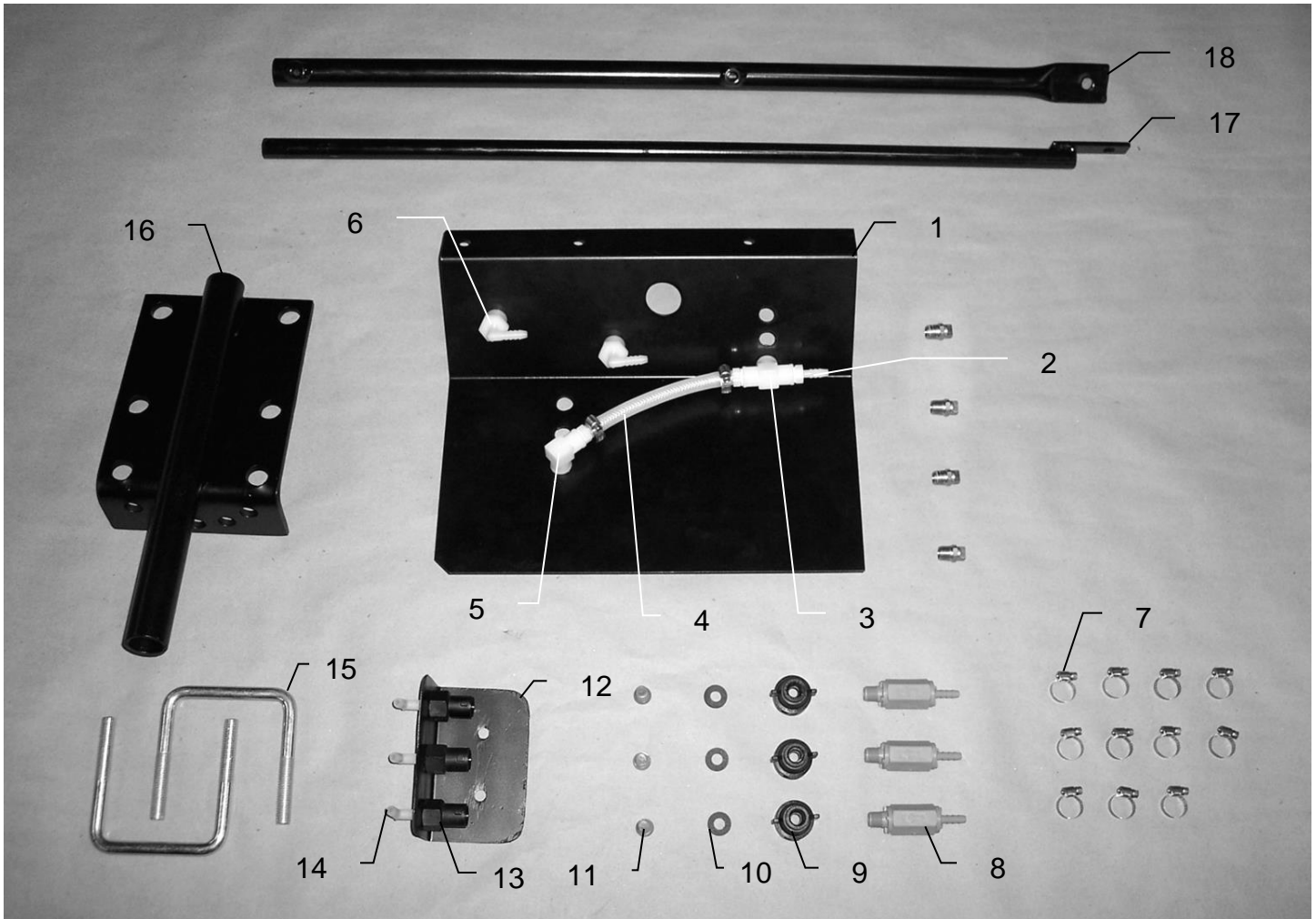

<u>Ref</u>	<u>Description</u>	<u>Part#</u>	<u>Qty</u>	<u>Description</u>	<u>Part#</u>	<u>Qty</u>
1	Spray shield	001-4426	1	Tip (silver)	004-T650033-SS	2
2	Straight fitting	003-A1414	3	Tip (silver)	004-T110015-SS	1
3	Tee	003-TT14SQ	1	Tip (silver)	004-T11003-SS	1
4	Hose	002-9016	9 ft			
5	Elbow	003-SE14F	1			
6	Elbow	003-EL1414F	2			
7	Hose clamp	003-9002	11			
8	Check valve	002-4564XB	3			
9	Female disconnect	004-1207H	3			
10	Washer	004-1207W	3			
11	Tip strainer	004-1203-200	3			
12	Hose bracket	001-4720	1			
13	Female coupler	004-1207G	3			
14	Elbow	003-EL1414	3			
15	U bolt	001-4406A	2			
16	Mounting bracket	001-4406	1			
17	Inside reach rod	001-4405	1			
18	Outside reach rod	001-4404	1			

Harvest Tec Model 4415B-SO Installation Kit

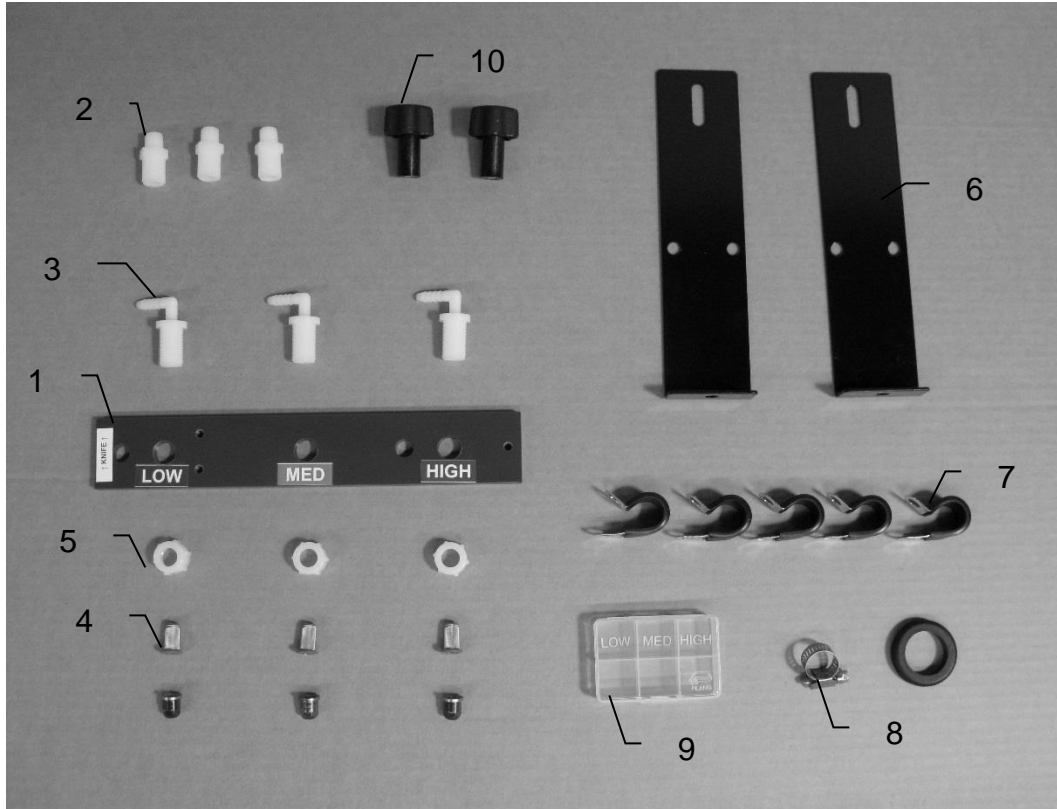

<u>Ref</u>	<u>Description</u>	<u>Part#</u>	<u>Qty</u>	<u>Description</u>	<u>Part#</u>	<u>Qty</u>
1	Spray shield	001-4425C	1	Tip (blue)	004-TX-SS-4	1
2	Drill guide	003-M3814NB	3	Tip (green)	004-TX-SS-10	1
3	Elbow	003-EL3814NB	3	Tip (brown)	004-TX-SS-18	1
4	Tip strainer	004-4213-100	3			
5	Nozzle cap	004-BC12	3			
6	Hose bracket	001-4425B	2			
7	Jiffy clip	008-9010	5			
8	Hose clamp	003-9003	3			
9	Tip box	008-9001	1			
10	Knob	008-0925	2			

Harvest Tec Model 4415B Installation Kit

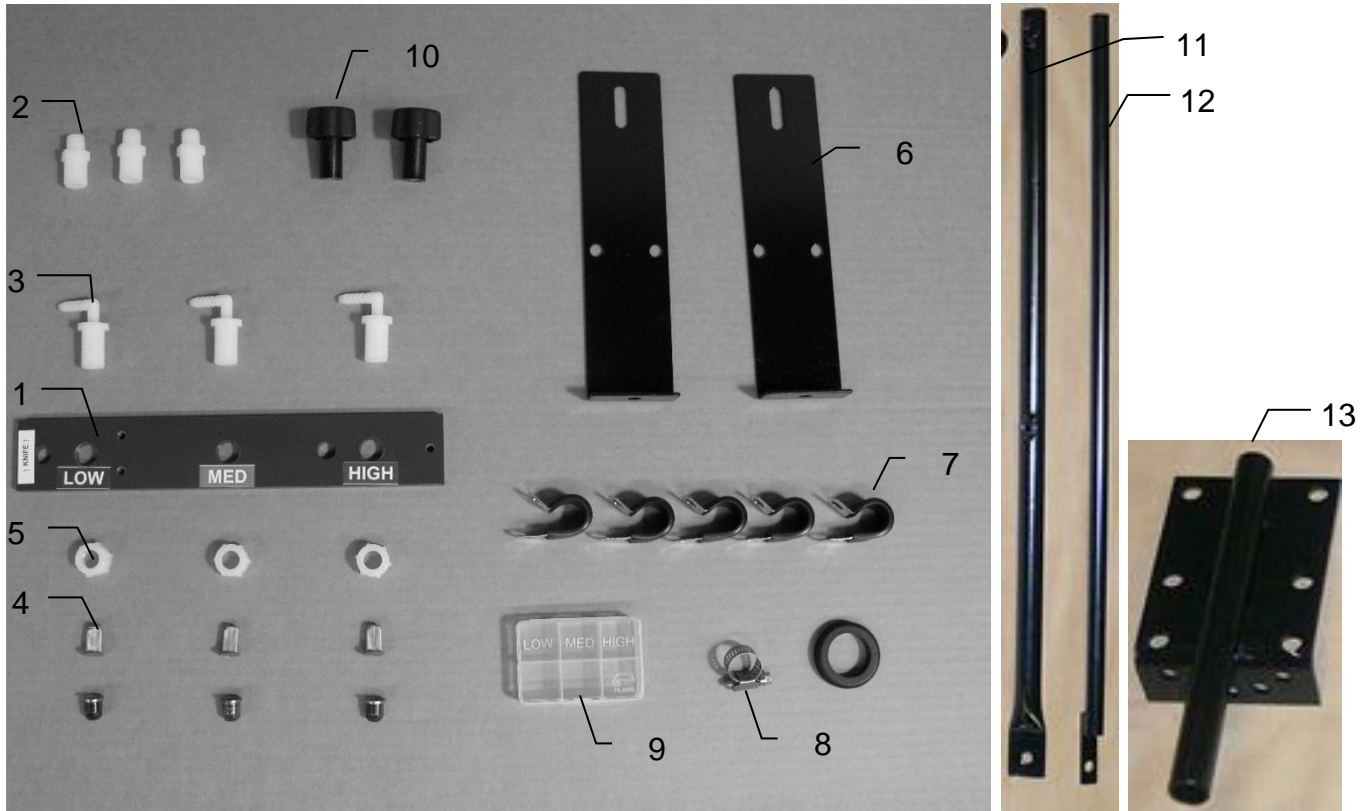

<u>Ref</u>	<u>Description</u>	<u>Part#</u>	<u>Qty</u>	<u>Ref</u>	<u>Description</u>	<u>Part#</u>	<u>Qty</u>
1	Spray shield	001-4425C	1	11	Inside reach rod	001-4405	1
2	Drill guide	003-M3814NB	3	12	Outside reach rod	001-4404	1
3	Elbow	003-EL3814NB	3	13	Mounting bracket	001-4406	1
4	Tip strainer	004-4213-100	3		Tip (blue)	004-TX-SS-4	1
5	Nozzle cap	004-BC12	3		Tip (green)	004-TX-SS-10	1
6	Hose bracket	001-4425B	2		Tip (brown)	004-TX-SS-18	1
7	Jiffy clip	008-9010	5				
8	Hose clamp	003-9003	3				
9	Tip box	008-9001	1				
10	Knob	008-0925	2				

Model 4416B Installation Kit

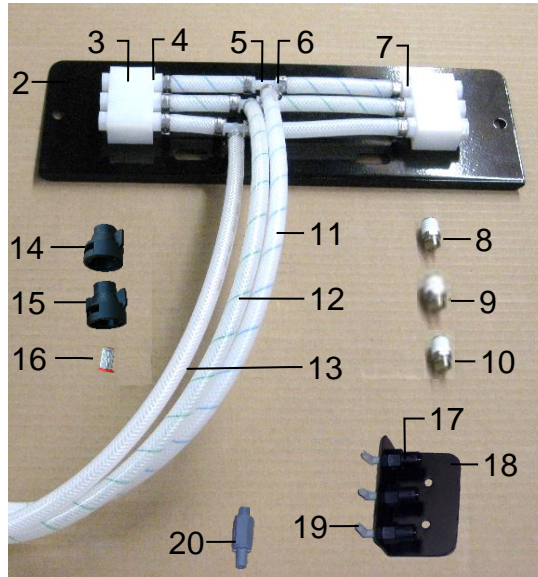

<u>Ref</u>	<u>Description</u>	<u>Part #</u>	<u>Qty</u>	<u>Ref</u>	<u>Description</u>	<u>Part#</u>	<u>Qty</u>
1	Saddle Legs	001-4703Q	2	14	1/4" Female Disconnect	004-1207H	3
2	Spray Shield	001-4424A2	1	15	Shut off cap	004-1207F	2
3	Plug	003-F14	6	16	Tip Strainer (200 mesh)	004-1203-200	3
4	Manifold Block	001-4435NSB	2	17	Female coupler	004-1207G	3
5	1/2" O-tiker Clamp	003-9008	15	18	Hose bracket	001-4720	1
6	1/4" Tee	003-T1414	3	19	Elbow	003-EL1414	3
7	1/4" Straight fitting	003-A1414	6	20	Check valve	002-4564XB	3
8	Stainless Tip (small)	004-T650067-SS	2	21	Kicker Bracket	001-4703QC	1
9	Stainless Tip (med)	004-T65015-SS	2	NP	Spray Shield Holders	001-4424B	2
10	Stainless Tip (large)	004-T650033-SS	2	NP	Mini Hose Clamp	003-9002	6
11	1/4" Hose (green)	002-9016G	4				
12	1/4" Hose (blue)	002-9016B	4				
13	1/4" Hose (clear)	002-9016	4				
					4416B – SO Kit	030-4416B-SO	
					(Includes Ref 2-13 & Spray Shield Holders)		

Model 4485B Installation Kit

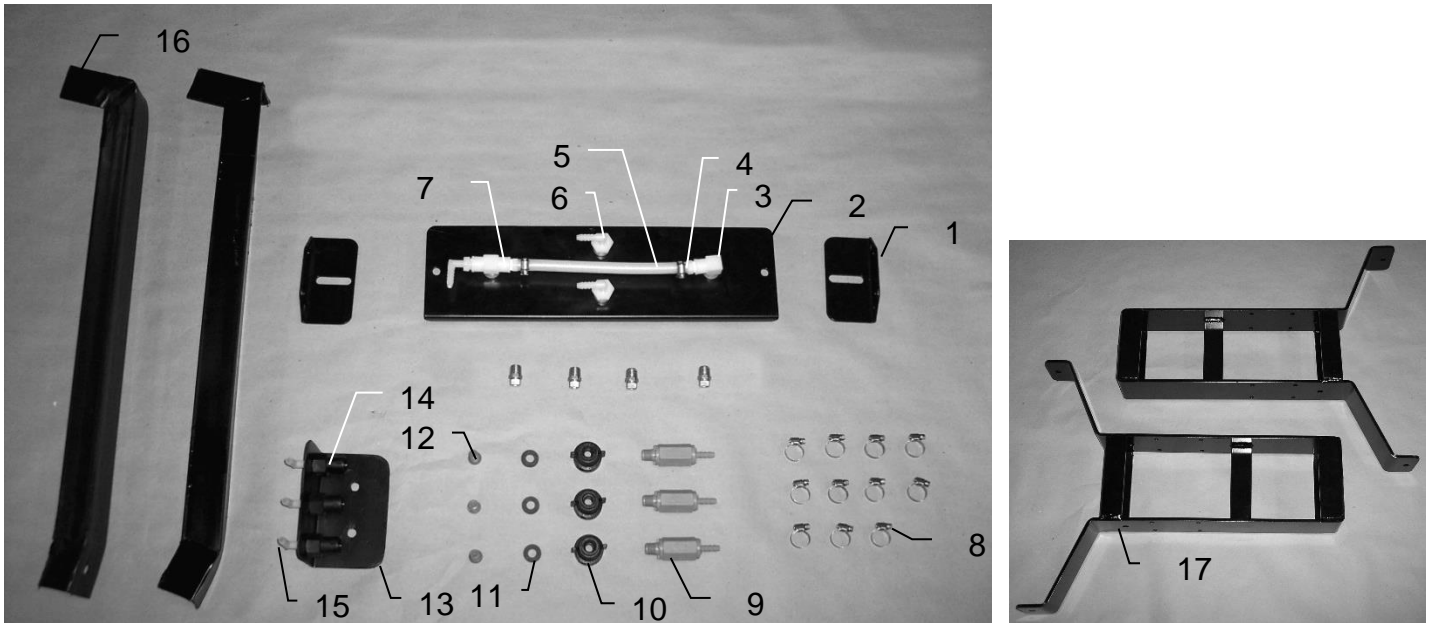

<u>Ref</u>	<u>Description</u>	<u>Part#</u>	<u>Qty</u>	<u>Ref</u>	<u>Description</u>	<u>Part#</u>	<u>Qty</u>
1	Shield holder	001-4424B	2		Tip (silver)	004-T650033-SS	2
2	Spray shield	001-4424A	1		Tip (silver)	004-T110015-SS	1
3	Elbow	003-SE14F	1		Tip (silver)	004-T11003-SS	1
4	Straight fitting	003-A1414	2				
5	Hose	002-9016	9 ft				
6	Elbow	003-EL1414F	2				
7	Tee	003-TT14SQ	1				
8	Hose clamp	003-9002	11				
9	Check valve	002-4564XB	3				
10	Female disconnect	004-1207H	3				
11	Washer	004-1207W	3				
12	Tip strainer	004-1203-200	3				
13	Hose bracket	001-4720	1				
14	Female coupler	004-1207G	3				
15	Elbow	003-EL1414	4				
16	Leg support	001-4424C	2				
17	Saddle leg	001-4703B	2				

Model 4502B Installation Kit

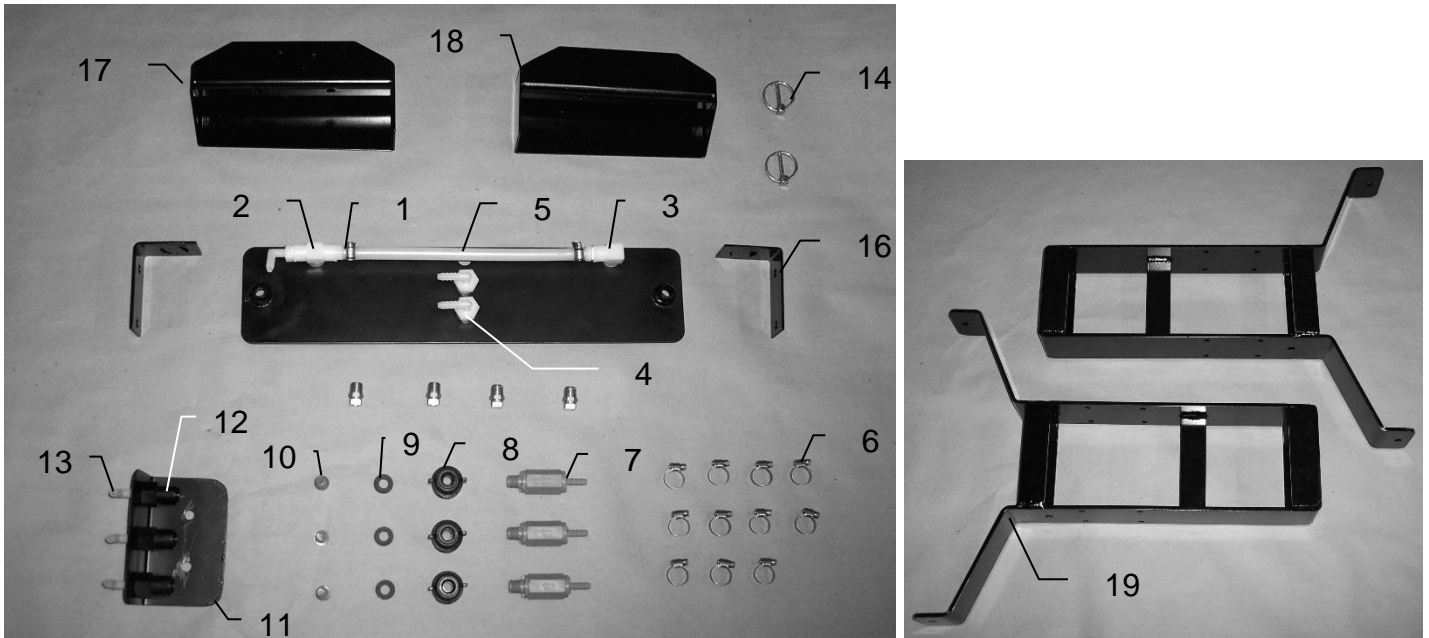

<u>Ref</u>	<u>Description</u>	<u>Part #</u>	<u>Qty</u>	<u>Description</u>	<u>Part#</u>	<u>Qty</u>
1	Straight fitting	003-A1414	2	Tip (silver)	004-T650050-SS	2
2	Tee	003-TT14SQ	1	Tip (silver)	004-T110015-SS	1
3	Elbow	003-SE14F	1	Tip (silver)	004-T11004-SS	1
4	Elbow	003-EL1414F	2			
5	Hose	002-9016	9ft			
6	Hose clamp	003-9002	11			
7	Check valve	002-4564XB	3			
8	Female disconnect	004-1207H	3			
9	Washer	004-1207W	3			
10	Tip strainer	004-1203-200	3			
11	Hose bracket	001-4720	1			
12	Female coupler	004-1207G	3			
13	Elbow	003-EL1414	4			
14	Lynch pin	008-4576	2			
15	Spray shield	001-4703G	1			
16	Shield holder	001-4703I	2			
17	Twine diverter (prox)	001-4644	1			
18	Twine diverter	001-4645	1			
19	Saddle leg	001-4703B	2			

Model 4506B Installation Kit

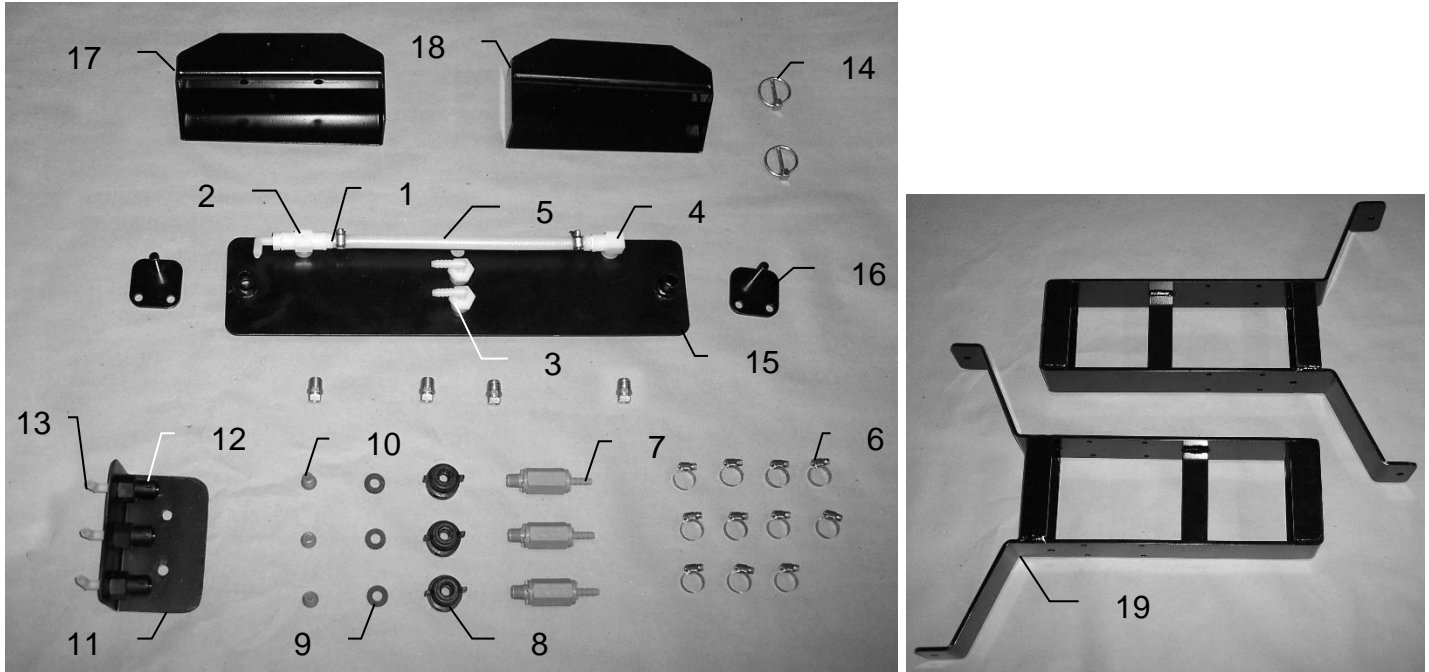

<u>Ref</u>	<u>Description</u>	<u>Part #</u>	<u>Qty</u>	<u>Description</u>	<u>Part#</u>	<u>Qty</u>
1	Straight fitting	003-A1414	2	Tip	004-T650050-SS	2
2	Tee	003-TT14SQ	1	Tip	004-T110015-SS	1
3	Elbow	003-EL1414F	2	Tip	004-T11004-SS	1
4	Elbow	003-SE14F	1			
5	Hose	002-9016	9ft			
6	Hose clamp	003-9002	11			
7	Check valve	002-4564XB	3			
8	Female disconnect	004-1207H	3			
9	Washer	004-1207W	3			
10	Tip strainer	004-1203-200	3			
11	Hose bracket	001-4720	1			
12	Female coupler	004-1207G	3			
13	Elbow	003-EL1414	4			
14	Lynch pin	008-4576	2			
15	Spray shield	001-4703G	1			
16	Shield holder	001-4703H	2			
17	Twine diverter (prox)	001-4644	1			
18	Twine diverter	001-4645	1			
19	Saddle leg	001-4703B	2			

Model 4507B Installation Kit - Three Tie Balers

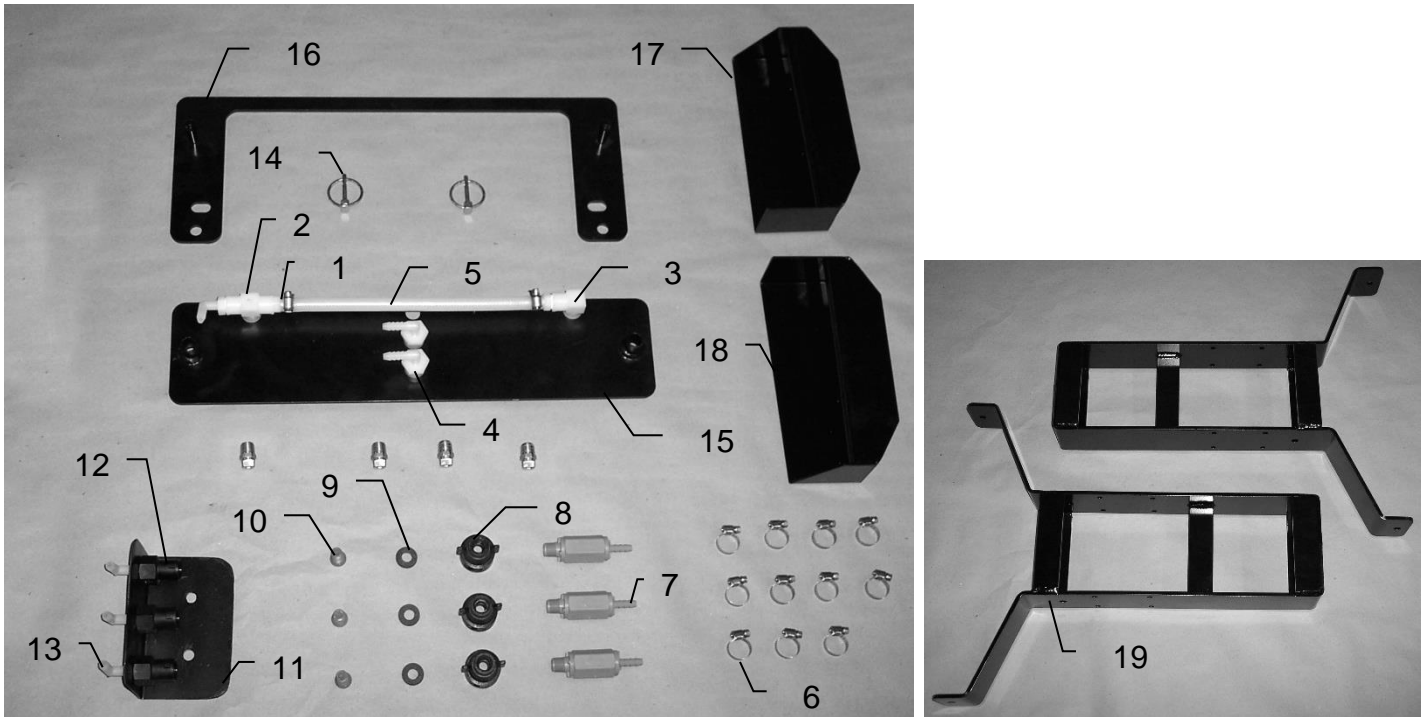

<u>Ref</u>	<u>Description</u>	<u>Part #</u>	<u>Qty</u>	<u>Description</u>	<u>Part#</u>	<u>Qty</u>
1	Straight fitting	003-A1414	2	Tip	004-T650050-SS	2
2	Tee	003-TT14SQ	1	Tip	004-T110015-SS	1
3	Elbow	003-SE14F	1	Tip	004-T11004-SS	1
4	Elbow	003-EL1414F	2			
5	Hose	002-9016	9 ft			
6	Hose clamp	003-9003	11			
7	Check valve	002-4564XB	3			
8	Female disconnect	004-1207H	3			
9	Washer	004-1207W	3			
10	Tip strainer	004-1203-200	3			
11	Hose bracket	001-4720	1			
12	Female coupler	004-1207G	3			
13	Elbow	003-EL1414	4			
14	Lynch pin	008-4576	2			
15	Spray shield	001-4703G	1			
16	Shield holder	001-4703J	1			
17	Twine diverter (prox)	001-4644	1			
18	Twine diverter	001-4645	1			
19	Saddle leg	001-4703B	2			

Optional iPad Mini Mounting Kit (030-2014MK)

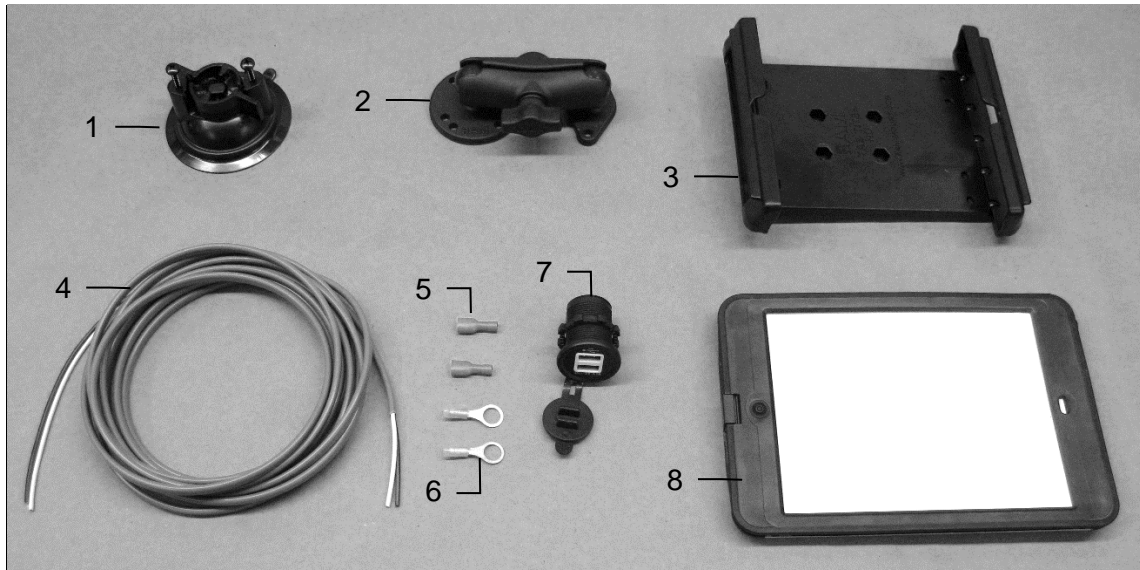

<u>Ref</u>	<u>Description</u>	<u>Part #</u>	<u>Qty</u>
1	Suction cup mount	001-2012SCM	1
2	Ram mount	001-2012H	1
3	iPad Mini® spring load cradle (Mini 4)	001-2012SLC	1
4	16 gauge power wire	006-4723P	1
5	Female spade connector	Hardware	2
6	Eye loop connector	Hardware	2
7	iPad Mini Charger 12V	001-2012P	1
8	iPad Mini 4 case	001-2012C4	1
NP	4 amp fuse	Hardware	1
Mounting Kit Assembly		030-2014MK (Includes All Parts)	

Installation Instructions

1. Identify 12V power source for wires to connect.
 - a. Eye loops included if wiring directly to the battery is desired.
 - b. Test for key power source if preferred to have power to the USB shut off with the key.
2. Once power source is identified, cut wires to desired length.
3. Crimp the two supplied quick connectors onto each the white and black wire.
4. Remove the round locking plastic nut from USB plug before connecting the wires. Black (+) White (-).
5. The wires will then be hooked to the designated terminals on the bottom of the USB plug
6. Drill a 1 1/8" hole in the preferred mounting location. Be sure to clean any sharp edges after drilling.
7. Feed the wires through the mounting hole.
8. If using the round plastic nut to secure plug in place, slide the nut back over the wiring before connecting the wires to powered source.
9. Connect the wires to the identified power source if easier to do so before tightening the plug into place.
10. Tighten plug using either the round plastic nut or mounting plate and two screws, both options supplied.
11. Once connected, hook a USB charging cord into the plug and connect a mobile device/tablet to ensure the plug is operating as you wish (key power working properly if necessary).

NOTE: This plug is not designed to charge two iPads. System damage could occur if this is attempted. System will charge a mobile phone and iPad simultaneously without problem.

*iPad mini is a trademark of Apple Inc., registered in the U.S. and other countries.

Optional iPad Display Kit (030-4670DK)

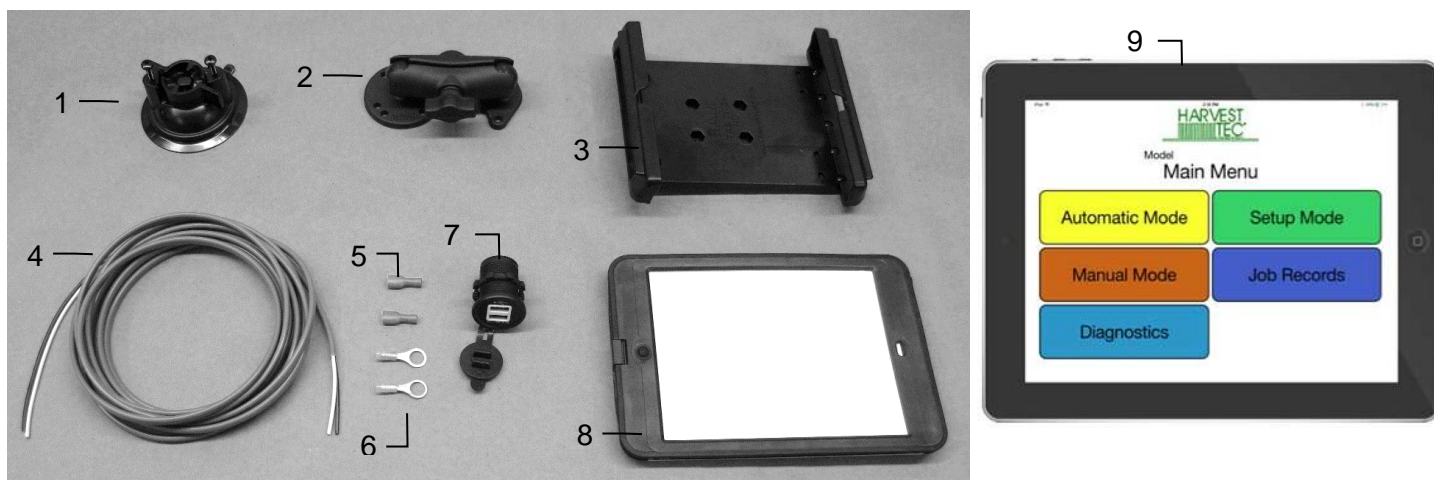

<u>Ref</u>	<u>Description</u>	<u>Part #</u>	<u>Qty</u>	<u>Ref</u>	<u>Description</u>	<u>Part #</u>	<u>Qty</u>
1	Suction cup mount	001-2012SCM	1	7	iPad Mini Charger 12V	001-2012P	1
2	Ram mount	001-2012H	1	8	iPad Mini 4 case	001-2012C4	1
3	iPad Mini® spring load cradle (Mini 4)	001-2012SLC	1	9	iPad Mini 4	006-4670IP	1
4	16 gauge power wire	006-4723P	1	NP	4 amp fuse	Hardware	1
5	Female spade connector	Hardware	2				
6	Eye loop connector	Hardware	2				
					Mounting Kit Assembly	030-4670DK (Includes All Parts)	

Installation Instructions

1. Identify 12V power source for wires to connect.
 - a. Eye loops included if wiring directly to the battery is desired.
 - b. Test for key power source if preferred to have power to the USB shut off with the key.
2. Once power source is identified, cut wires to desired length.
3. Crimp the two supplied quick connectors onto the white and black wire.
4. Remove the round locking plastic nut from USB plug before connecting the wires. Black (+) White (-).
5. The wires will then be hooked to the designated terminals on the bottom of the USB plug
6. Drill a 1 1/8" hole in the preferred mounting location. Be sure to clean any sharp edges after drilling.
7. Feed the wires through the mounting hole.
8. If using the round plastic nut to secure plug in place, slide the nut back over the wiring before connecting the wires to powered source.
9. Connect the wires to the identified power source if easier to do so before tightening the plug into place.
10. Tighten plug using either the round plastic nut or mounting plate and two screws, both options supplied.
11. Once connected, hook a USB charging cord into the plug and connect a mobile device/tablet to ensure the plug is operating as you wish (key power working properly if necessary).

NOTE: This plug is not designed to charge two iPads. System damage could occur if this is attempted. System will charge a mobile phone and iPad simultaneously without problem.

*iPad mini is a trademark of Apple Inc., registered in the U.S. and other countries.

Harvest Tec Inc. Warranty and Liability Agreement

Harvest Tec, Inc. will repair or replace components that are found to be defective within 12 months from the date of manufacture. Under no circumstances does this warranty cover any components which in the opinion of Harvest Tec, Inc. have been subjected to negligent use, misuse, alteration, accident, or if repairs have been made with parts other than those manufactured and obtainable from Harvest Tec, Inc.

Our obligation under this warranty is limited to repairing or replacing free of charge to the original purchaser any part that in our judgment shows evidence of defective or improper workmanship, provided the part is returned to Harvest Tec, Inc. within 30 days of the failure. If it is determined that a non-Harvest Tec branded hay preservative has been used inside the Harvest Tec applicator system where the failure occurred, then Harvest Tec reserves the right to deny the warranty request at their discretion. Parts must be returned through the selling dealer and distributor, transportation charges prepaid.

This warranty shall not be interpreted to render Harvest Tec, Inc. liable for injury or damages of any kind, direct, consequential, or contingent, to persons or property. Furthermore, this warranty does not extend to loss of crop, losses caused by delays or any expense prospective profits or for any other reason. Harvest Tec, Inc. shall not be liable for any recovery greater in amount than the cost or repair of defects in workmanship.

There are no warranties, either expressed or implied, of merchantability or fitness for particular purpose intended or fitness for any other reason.

This warranty cannot guarantee that existing conditions beyond the control of Harvest Tec, Inc. will not affect our ability to obtain materials or manufacture necessary replacement parts.

Harvest Tec, Inc. reserves the right to make design changes, improve design, or change specifications, at any time without any contingent obligation to purchasers of machines and parts previously sold.

Revised 4/17

HARVEST TEC, INC.
P.O. BOX 63
2821 HARVEY STREET
HUDSON, WI 54016
PHONE: 715-386-9100
1-800-635-7468
FAX: 715-381-1792
Email: info@harvesttec.com