

# Operation Manual

***Model 696M***

***110 Gallon Preservative Applicator***



**HayBoss™**  
**G2**

(intentionally blank)

# HayBoss G2 Model 696M Operations Table of Contents

	<u>PAGE</u>
<b>Introduction</b>	<b>4</b>
<b>System Requirements</b>	<b>4</b>
<b>Safety</b>	<b>4</b>
<b>Safety Decals</b>	<b>5</b>
<b>Safety Sign Locations</b>	<b>6</b>
<b>Preparing the Applicator for Operation</b>	<b>7-8</b>
Filling the Tank	7
Power and Communication Harnesses	8
Operation of the Main Ball Valve	8
<b>Operation of the ISOBUS Monitor</b>	<b>9-12</b>
<b>Baler Monitor Setup / View – UHD Baler Only</b>	<b>13</b>
<b>Selecting the HayBoss G2 Preservative Applicator</b>	<b>14</b>
<b>Descriptions of Screens and Menus</b>	<b>15-20</b>
Automatic Mode	16
Manual Mode	17
Diagnostics	18
Setup Mode	19-20
Job Records	21
<b>First time and Annual Startup Instructions</b>	<b>22</b>
<b>Setting up Application Rate and Bale Parameters for Initial Use</b>	<b>23-24</b>
Application Rate Setup	22
Selecting High or Low Tips	23
Bale Rate Setup	24
<b>Operating Instructions</b>	<b>25-29</b>
Automatic mode	25
Manual mode	26
Diagnostics	27
Job Records	28-29
<b>Common Questions</b>	<b>30</b>
<b>Bluetooth Receiver</b>	<b>31</b>
<b>Maintenance</b>	<b>31-33</b>
Maintenance Schedule, Diagnostics	31
Cleaning: Filter Bowl, Tips and Tip Screen,	31-32
Winter Storage	32
Tank Lid Cleaning	33
Dielectric Grease Connections	33
Rebuild Pumps	33
Battery Connections	33
Check Valves	33
Miscellaneous Maintenance	33
<b>Troubleshooting</b>	<b>34-35</b>
<b>Wiring Diagrams</b>	<b>36-37</b>
<b>Pin Outs</b>	<b>38-40</b>
<b>Parts Breakdown</b>	<b>41-53</b>
Tank, Saddle and Legs	41
Pump Manifold	42
Star Wheel Sensors	43
Control Boxes and Wiring Harnesses	44
Hose and Drain / Fill Line	45
Optional iPad Mini Mounting Kit	46
Optional iPad Display Kit	47
4518B Installation Kit	48
4519B Installation Kit	49
4527B Installation Kit	50
4530B Installation Kit	51
4542B Installation Kit	52
4544B Installation Kit	53
<b>Notes</b>	<b>54</b>
<b>Warranty statement</b>	<b>55</b>

## Introduction

Thank you for purchasing a HayBoss G2 Model 696M Hay Preservative Applicator. This 696M applicator system has been designed to plug directly into the baler's ISOBUS and display on a C1000 monitor. As well as the option of operation through an Apple iPad (not included) using the Hay App. The 696M Preservative Applicator System offers these advantages:

1. Operation coordinated with baler operation
2. Less cab clutter providing better visibility
3. Ease of use with all information on one screen
4. Records kept together
5. And the system is ready for future updates.

The 696M HayBoss G2 Preservative Applicator System is designed to apply buffered propionic acid to the forage crop as it is baled. The 696M applicator will adjust the rate of application based on moisture and tonnage of the crop being harvested. This manual will take you through the steps of installing the applicator. Failure to follow instructions can result in personal injury or equipment malfunction. If you are in need of parts for the system please view the Parts Breakdowns toward the back of this manual and contact your local authorized dealer to order the parts. This applicator is designed to apply AGCO buffered propionic acid.

Right and Left sides are determined by facing in the direction of forward travel.

## System Requirements



**The Baler Processor must have Version 3.3 or higher.  
C1000 must have version 3.0.1 or higher**



**\*Made for iPad® running the current iOS operating system  
or one version previous required for iPad option**

\*iPad is a trademark of Apple Inc., registered in the U.S. and other countries.

**\*\*600 Series Applicators with serial number before DCP27000 will require the DCP to be sent to Harvest Tec for a required update in order to use the iPad Integration Module (030-6672C).**

\*Hay App version must be **at least 2.5.18 (or higher)** to operate with the iPad Integration Module

## Safety

Carefully read all the safety signs in this manual and on the applicator before use. Keep signs clean and visible. Replace missing or damaged safety signs. Replacement signs are available from your local authorized dealer. See your installation manual under the replacement parts section for the correct part numbers.

Keep your applicator in proper working condition. Unauthorized modifications to the applicator may impair the function and/or safety of the machine.

Carefully read and understand all of the baler safety signs before installing or servicing the baler. Always use the supplied safety equipment on the baler to service the applicator.

## Safety Decals

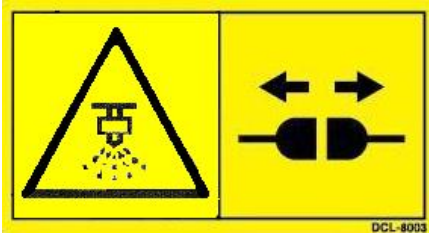

Number 1  
Spraying hazard. Disconnect power before servicing the applicator  
Part no. DCL-8003



Number 2  
Falling hazard. Do not step in this area.  
Part no. DCL-8002



Number 3  
Use caution when working around chemicals. **Wear all protective equipment according to the label of the product.**  
Part no. DCL-8001



Number 4  
Read and understand the operator's manual before using or working around the equipment.  
Part no. DCL-8000

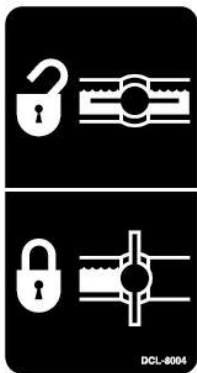

Number 5  
Open (unlocked) and closed (locked) position of the ball valve.  
Part no. DCL-8004

# Safety Sign Locations

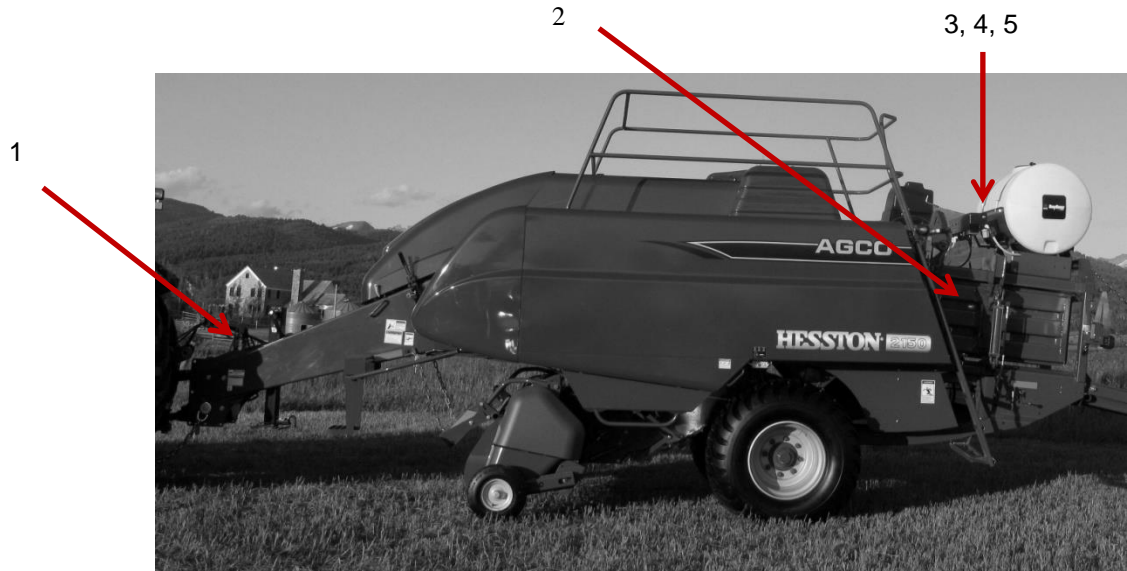

## Preparing the Applicator for Operation

After the Applicator has been installed on the baler, please follow the steps below to prepare for operating the applicator both safely and correctly.

### Filling the Tank:

Read the label of the product you choose to fill the tank to determine individual protective measures you the operator should take. Locate the drain/fill line on the right side of the baler. Open the cam-couplers (A) and remove the protective plug (B). Insert the male coupler (found on transfer pump) into the female cam and close the cams (A). To open the ball valve (C) turn the handle so it is vertical. After the ball valve has been turned on switch the pump to the On position. Monitor the level on the tank visually and shut off the pump before over filling. Once the pump is turned off, close the ball valve and remove the male coupler. The handle of the ball valve (C) will be horizontal when closed. Reinstall the protective plug and close the cams. The Harvest Tec model 9212 transfer pump is recommended for this process.

Water is recommended for first time and annual start up procedures.

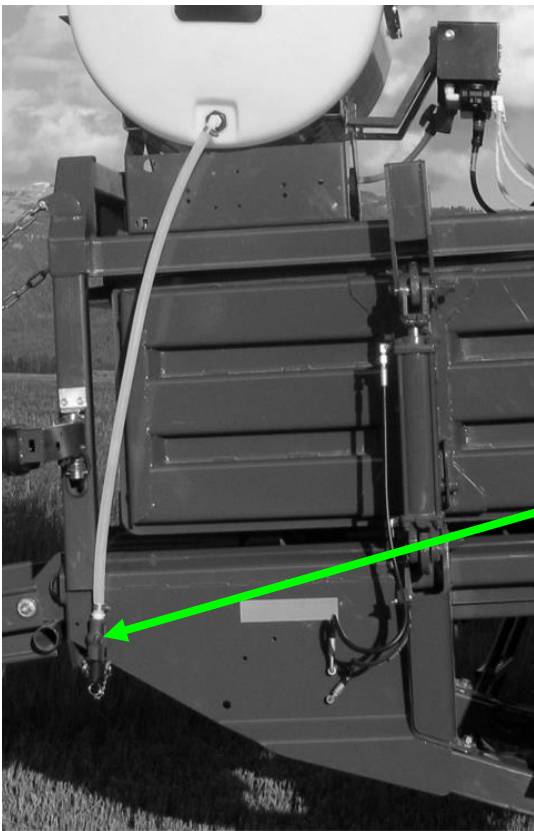

Drain/Fill line on right side of baler

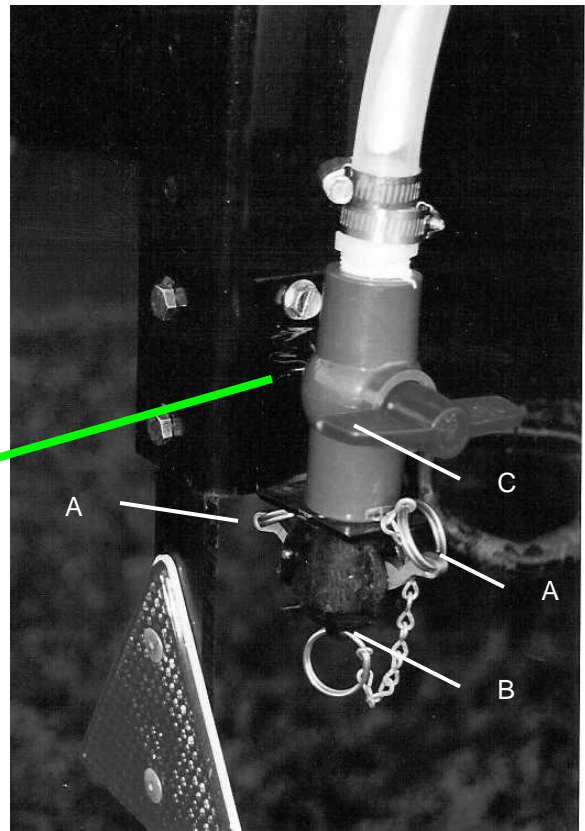

Enlarged view of the drain/fill line valve and cam-coupler assembly.



## Power and Communication Harness

***The power harness should be disconnected before service work on the baler or the applicator.***

The harnesses are located at the front of the baler near the hitch and at the back of the tractor near the drawbar. See arrow below. Make sure all connection wires are free between the hitch of the baler and the back of the tractor, especially when tractor is turning away.

**WARNING: Stop tractor engine and shift to park, set brakes and remove key before leaving the tractor.**



## Operation of the Main Ball Valve

The ball valve shall be closed at all times when the applicator is not being used. The valve shall also be closed when any service work is being done to the baler or applicator.

The ball valve is located on the left side of the baler, connected to the pumping manifold. See arrow below.

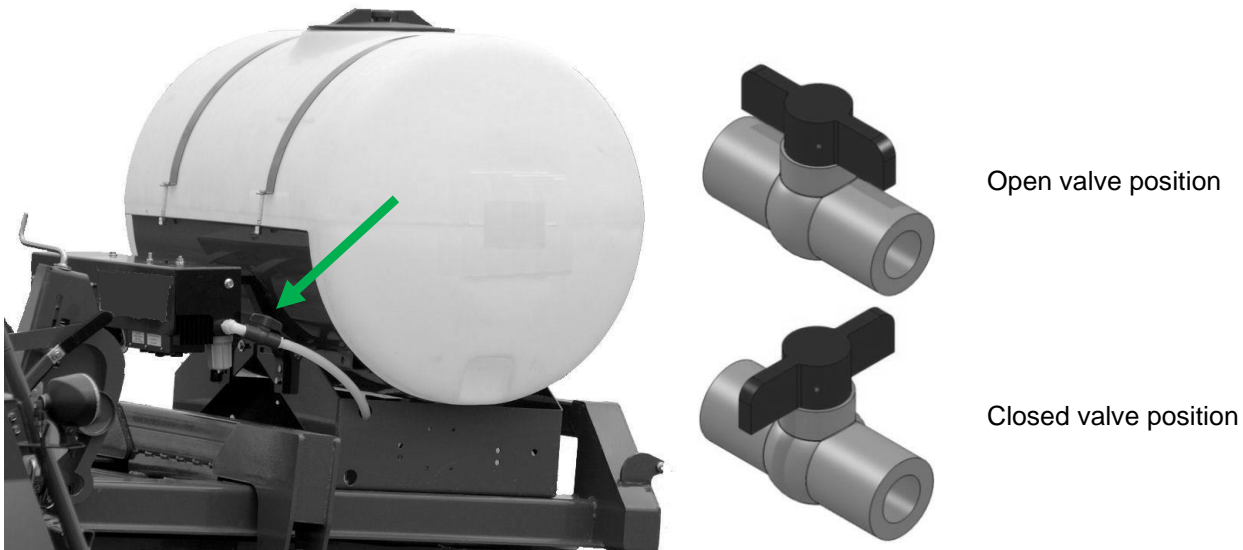



## Operation of the ISOBUS Monitor

The ISOBUS Monitor utilizes a combination of soft keys, number menus, and the scroll wheel on the upper right side of the actual monitor to make selections. Selections are made by scrolling the Thumb Wheel and pressing in once the selection is highlighted. All buttons are labeled and color coded.



## Baler Monitor Setup

At any time after the initial Start Up/Power On the green "uploading data status bar (arrow A) should begin to fill. To begin setup of the HayBoss G2 Preservative Applicator System select the fourth icon down on the right screen menu-the wrench icon (arrow B).

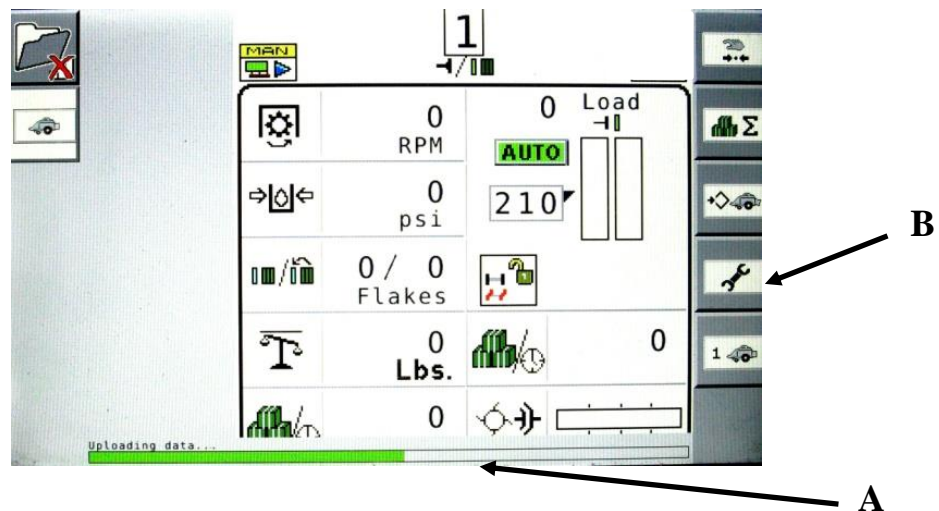

The service screen displayed below will appear. Here you can see the Version of Software for your baler which should be 3.30 or higher to enable working with the Preservative Applicator. Select the icon (arrow C) located at the bottom of the right selection menu to move to the next options menu.

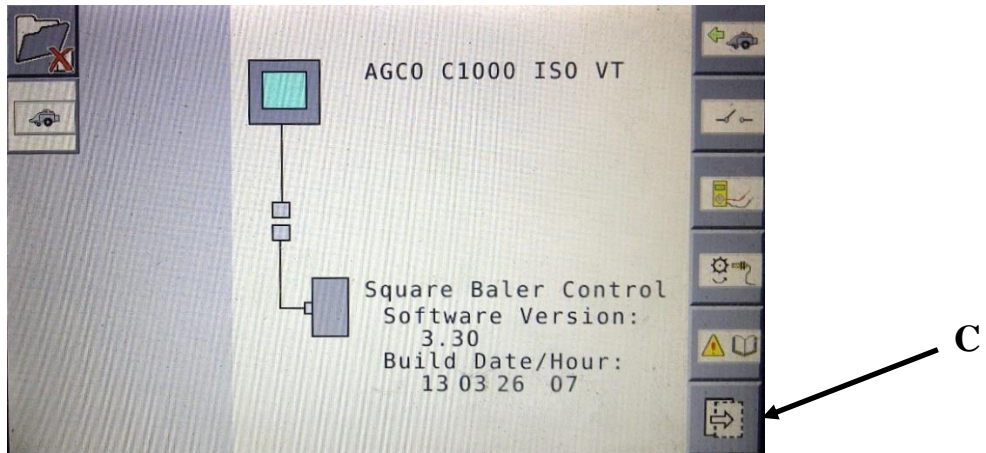

Then select the A B icon (arrow D) on the right side, this should be the top button.

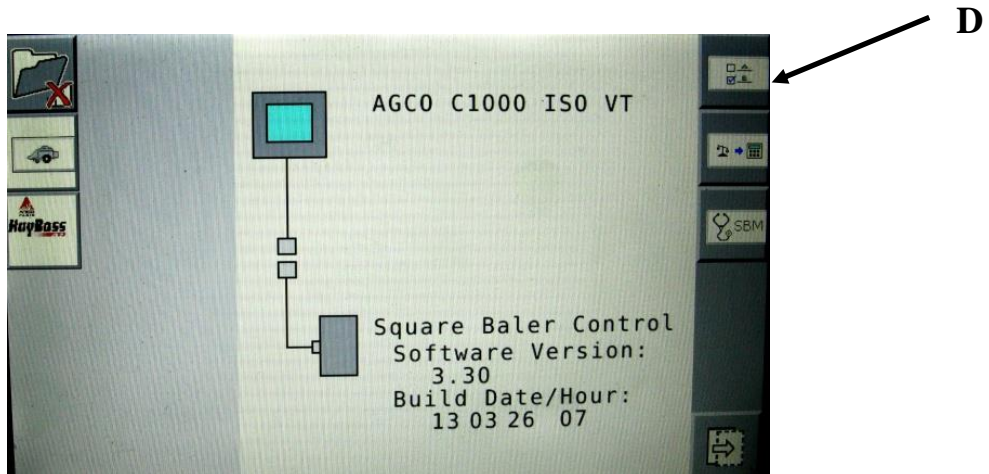

Then select the A B 2 icon (arrow E) on the right side to enter the next baler options screen.

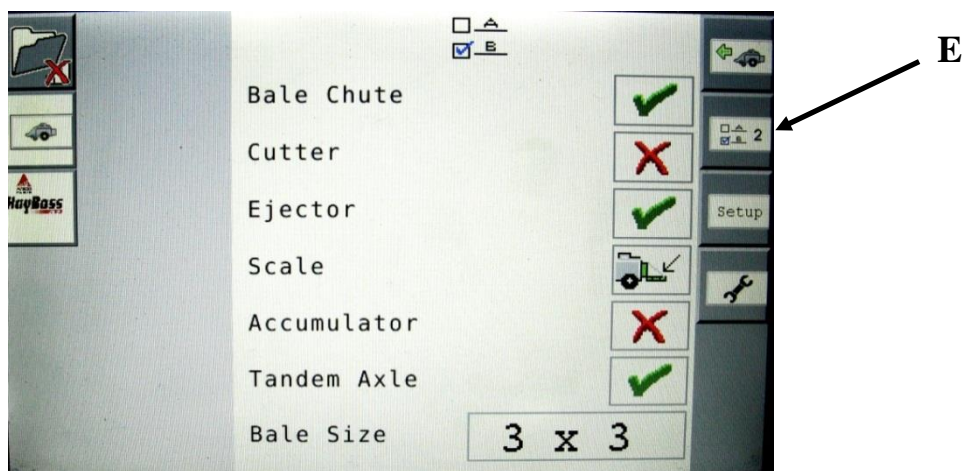

Use the thumb wheel to scroll and select the Harvest Tec Option (arrow F). Press the scroll wheel to open the drop down menu.

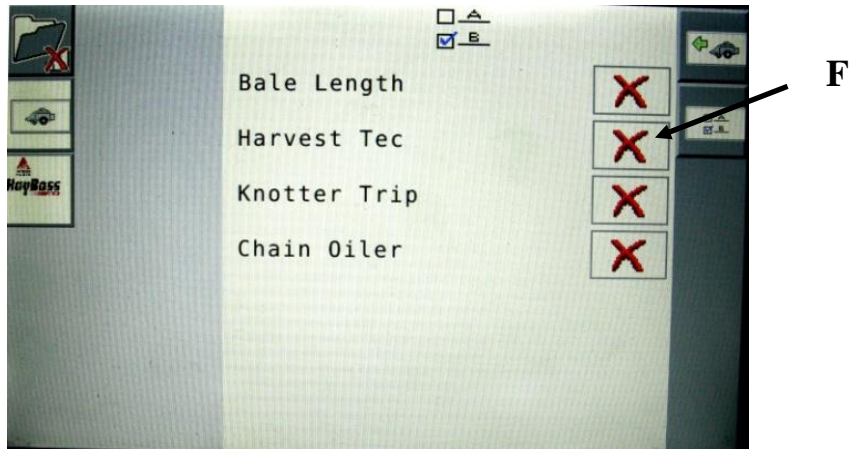

Select the green check mark to turn the Harvest Tec option ON (arrow G). Then select the Baler Run Screen button (arrow H) to save the setting and proceed to the baler run screen.

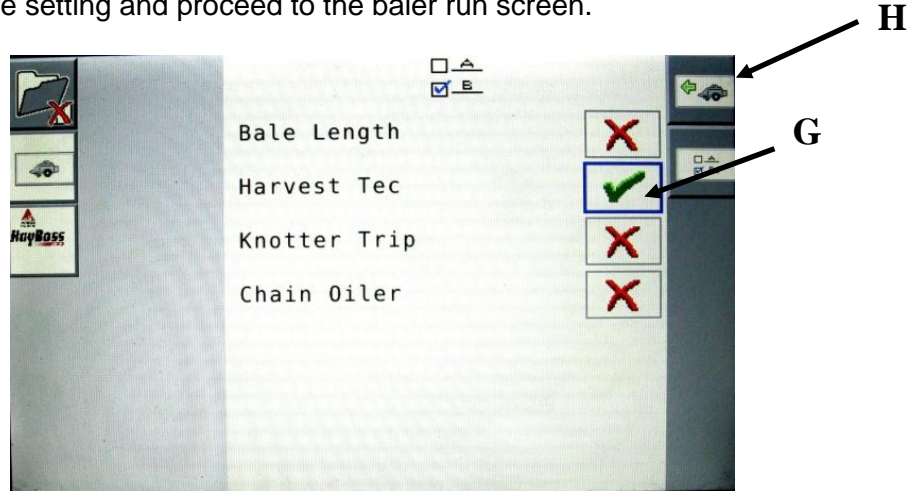

Use the scroll wheel to select a container option on the baler run screen. Harvest Tec information can be displayed in any container on the baler run screen. Press the scroll wheel to open the drop down menu and scroll to select the "HT Preservative" (arrow I) option and press the scroll wheel to select it. This will place the preservative information, "Actual" and "Target" values, in that position on the screen.

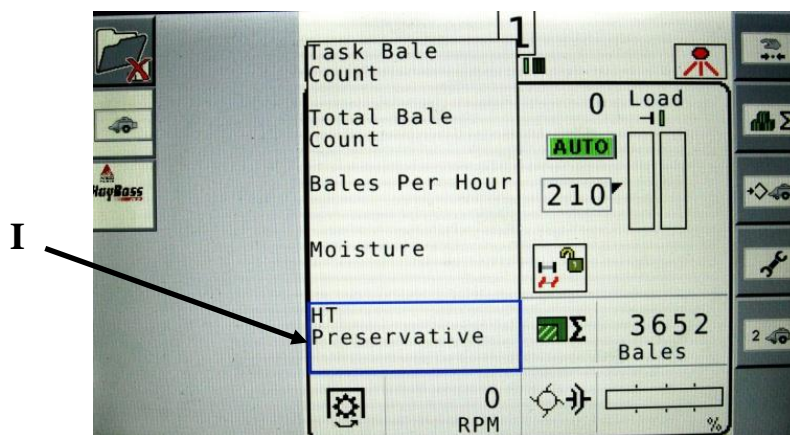



Follow the same steps as noted above to select a container for the moisture information (arrow J). This will place the “Instantaneous” and “Last Bale” moisture values in this position on the screen.

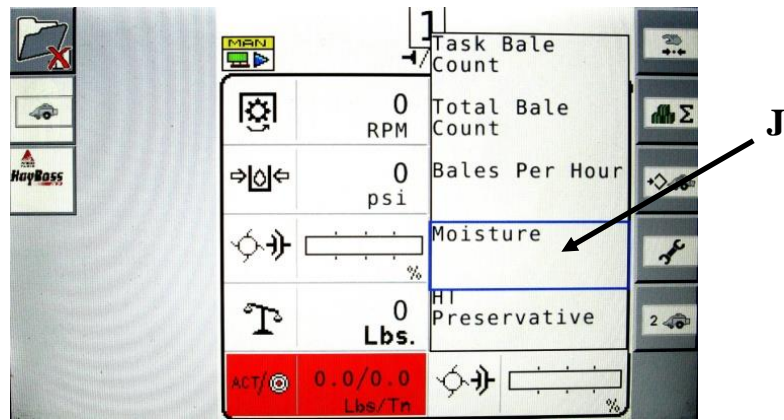

Once the HT Preservative and Moisture options are selected, the containers should show with a red background. The preservative information is denoted by “ACT” for actual and a target icon for the target value. These values are separated by a slash.

The moisture information is denoted by a rain droplet for instantaneous and a rain drop with a back arrow above for the last bale average moisture. These values are separated by a slash. And a preservative icon will show in the top right corner of the screen (arrow K).

**\*\*NOTE:** When the preservative icon is RED, the preservative system is not in a run mode (Auto or Manual). When the system is in a run mode, the icon will be GREEN. The HT Preservative and Moisture containers will have RED background when the system is not in a run mode.

The background for the preservative and moisture container will be WHITE, matching the rest of the baler run screen when the system is in Auto or Manual mode.

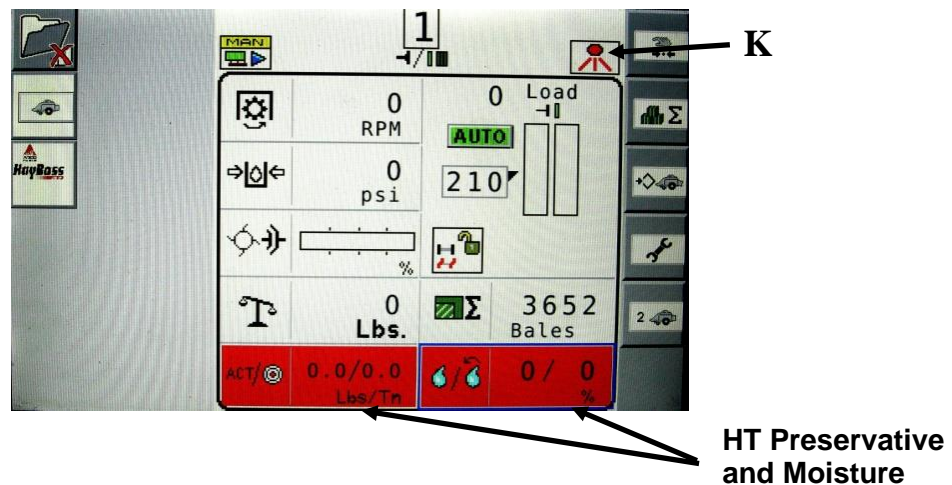

# Baler Monitor Setup / View – UHD Baler Only

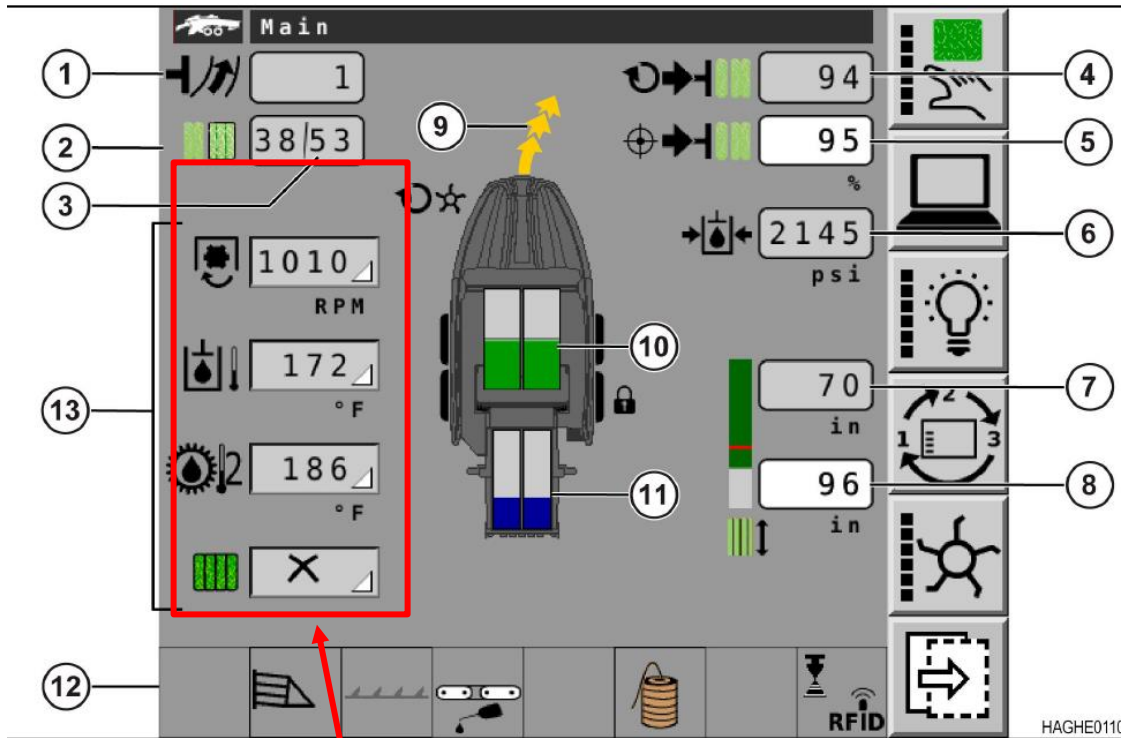

These four containers can be configured by the operator. In the selectable list are the items for your system. They are Current moisture, average moisture, applicator target rate, and applicator actual rate. When moisture is above your alarm setpoint it will show the moisture value with a red background.

This container is reserved for the moistures system. It shows the tagger status and applicator status. When moisture is above your setpoint it will turn the background red and show the percent moisture icon in the upper right corner.

Background turns red when your system is on main work screen. Icon Blinks when the system is paused.

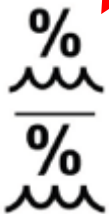

Current Moisture

Average Moisture



Preservative Applicator Target Rate

Preservative Applicator Actual Rate



Moisture System On. The icon will flash when the system is paused

Moisture System Off



Tagger Installed and On. This icon will flash when a tag is applied. There is also a % symbol that shows in the top right corner if the bale moisture goes over the limit

## Selecting the HayBoss G2 Preservative Applicator

The soft keys down the left side of the monitor correlate with choosing connected implements or files. Depending on your specific situation this could show your tractor, camera, baler or the HayBoss G2 Preservative Applicator System among others. To enter the HayBoss G2 menu screens, select the soft key next to the HayBoss G2 icon (Arrow L). Once the HayBoss G2 option has been selected, the Main Menu screen will show as seen below.

The numbered and colored soft keys on the right side (1-6) correlate to the selection options on the screen. For example, Automatic Mode is YELLOW and has a number "1" in the corner of the button (Arrow M), this correlates to the YELLOW number "1" soft key option on the right side (Arrow N). So to enter Automatic Mode, the scroll wheel can be used to select the button or the soft key next to the YELLOW number "1" option can be pressed. To return to the baler work screen select the baler icon (arrow O).

The cycle button (Arrow P) can be used to toggle between connected implements. This is located at the bottom of the monitor next to the Home and Esc buttons.

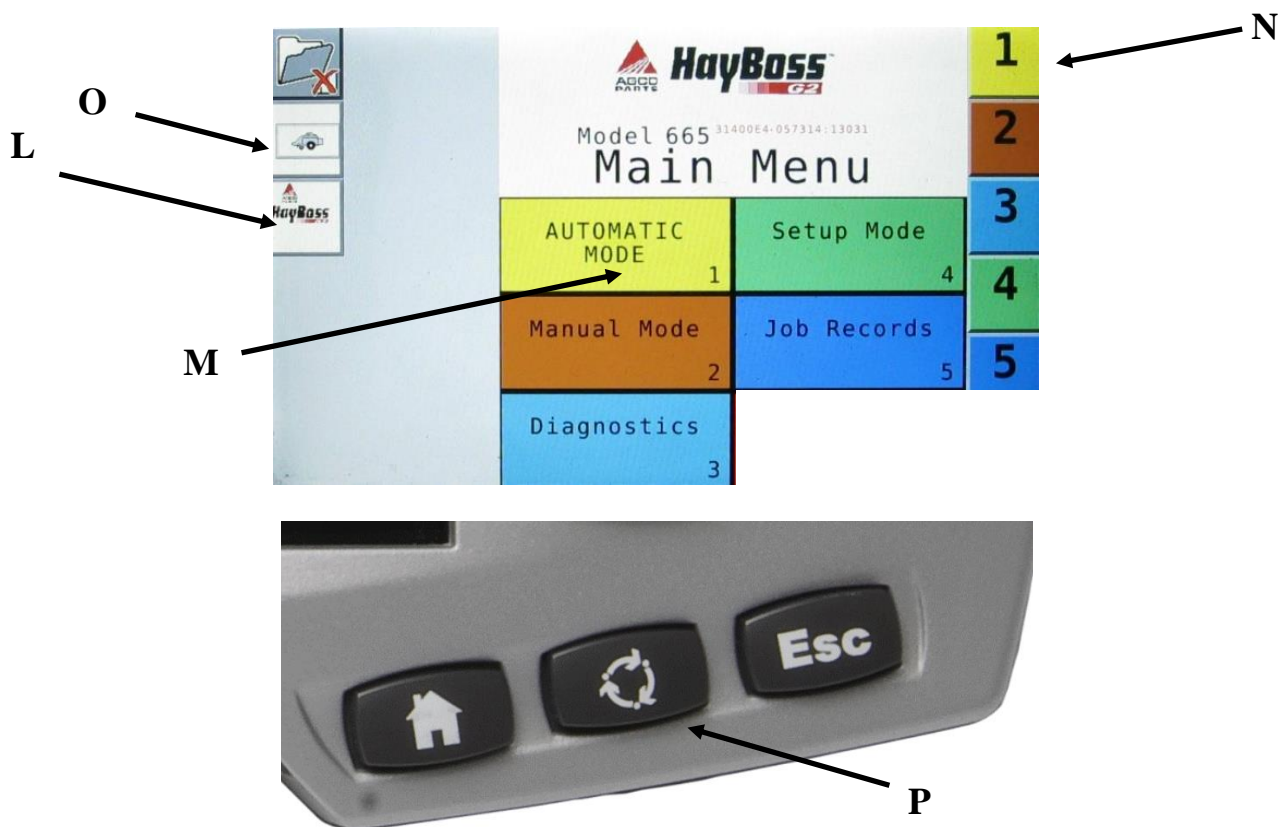

## Description of Screens, Menus and Soft Keys for the ISOBUS Monitor

All Buttons are color coded and labeled. The numbers down the right side represent the soft key to select or press.

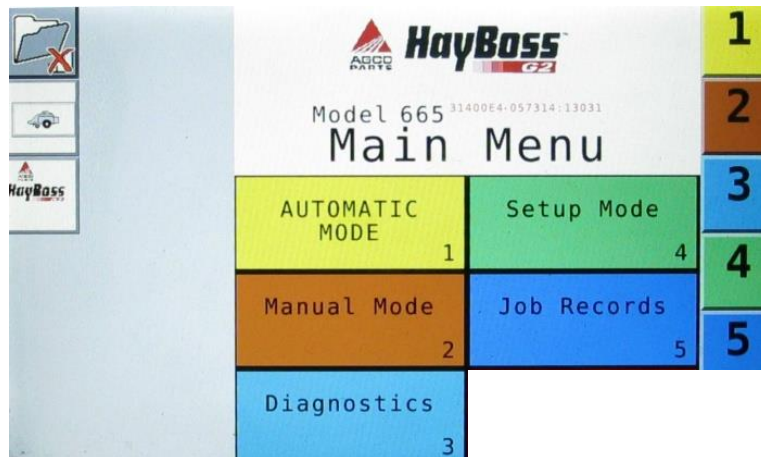

**Main Menu for the Hay Preservative**

Listed below are the Main Menu Options.

**Automatic Mode ( 1 )** This operating mode automatically adjusts preservative application as you bale. The following items are displayed in the mode while baling: Moisture, Baling Rate, Application Rate (actual and target), Last Bale Average Moisture, Tons Baled, and Pounds of Product Used.

**Manual Mode ( 2 )** This operating mode allows the three different pumps to be turned on at a fixed rate as you bale. The following items are displayed in the mode while baling: Moisture, Baling Rate, Application Rate (actual only), Last Bale Average Moisture, Tons Baled, and Pounds of Product Used. This mode can also be used to prime the pumps.

**Diagnostics ( 3 )** Allows operator to set the date and time. The installed software versions can also be viewed here.

**Setup Mode ( 4 )** This mode allows the operator to customize the applicators settings for their baler and baling needs. This mode allows changes to be made to the following areas: Application Rate, Baling Rate, Language, US or Metric units, and turn on/off the optional Hay Indicators.

**Job Records ( 5 )** Keeps track of up to 300 plus jobs with total product used, average moisture content, highest moisture content, tons baled, date of baling, and total number of bales made. Individual bales are also able to be viewed and the records can also be downloaded to a USB drive in this mode.



## Screen Menus

Use the below listed screen menus to navigate through all of the operation screens. Navigation through the screens and buttons is accomplished by using the selection method of the controller: touch screen, soft keys, or thumb wheel scrolling and pressing.

### Automatic Mode:

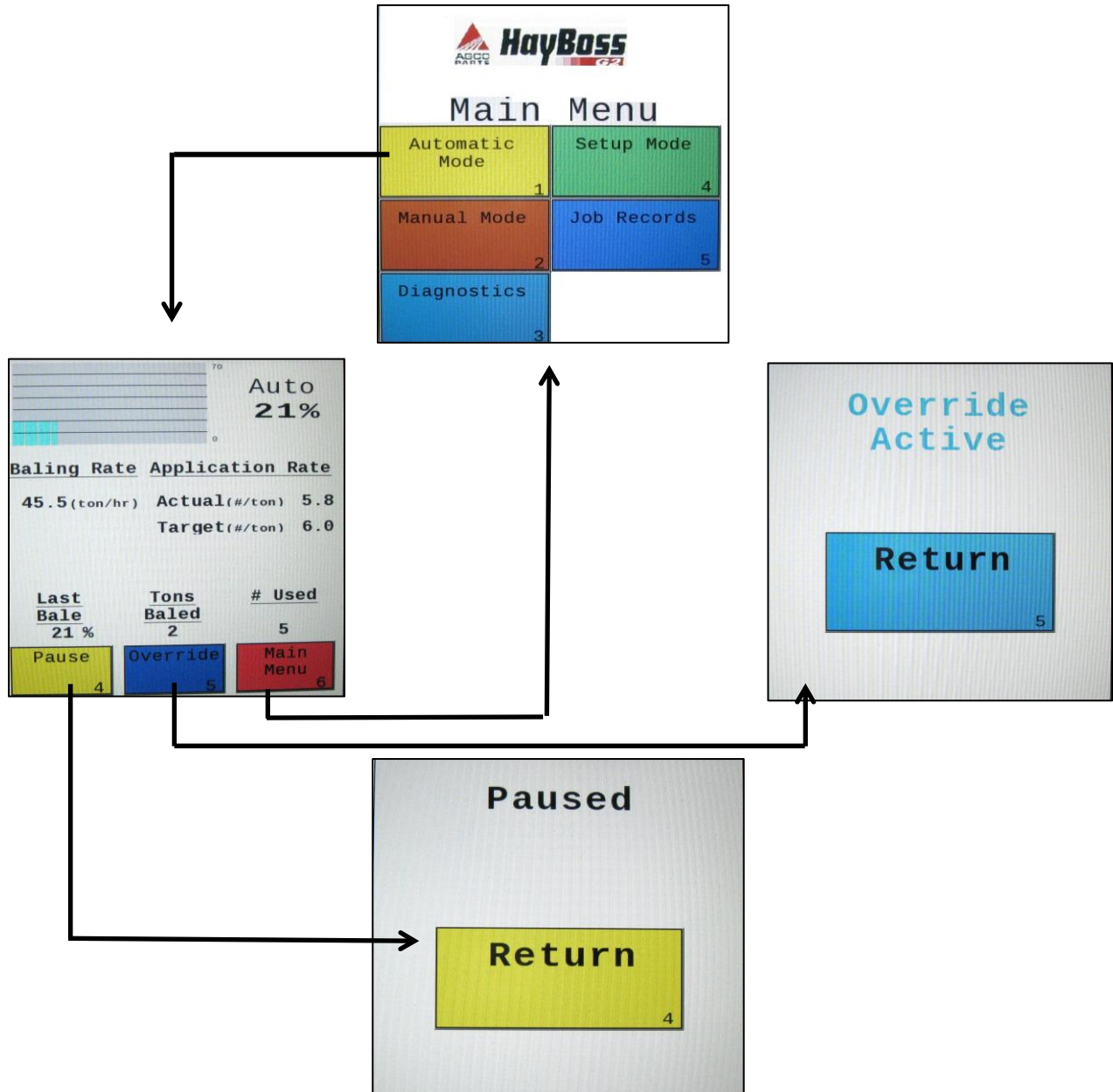

Manual Mode:

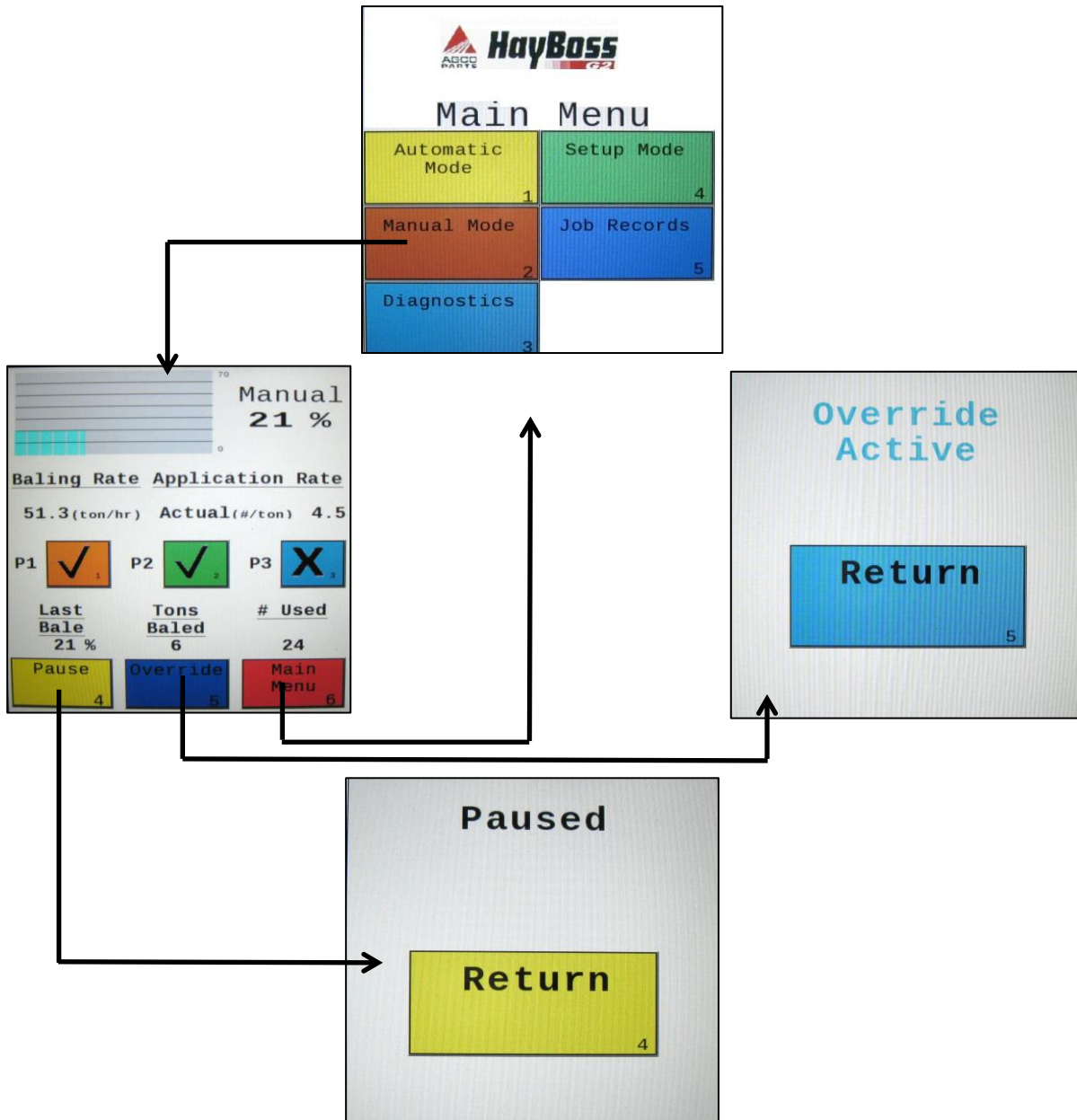

Diagnostics:

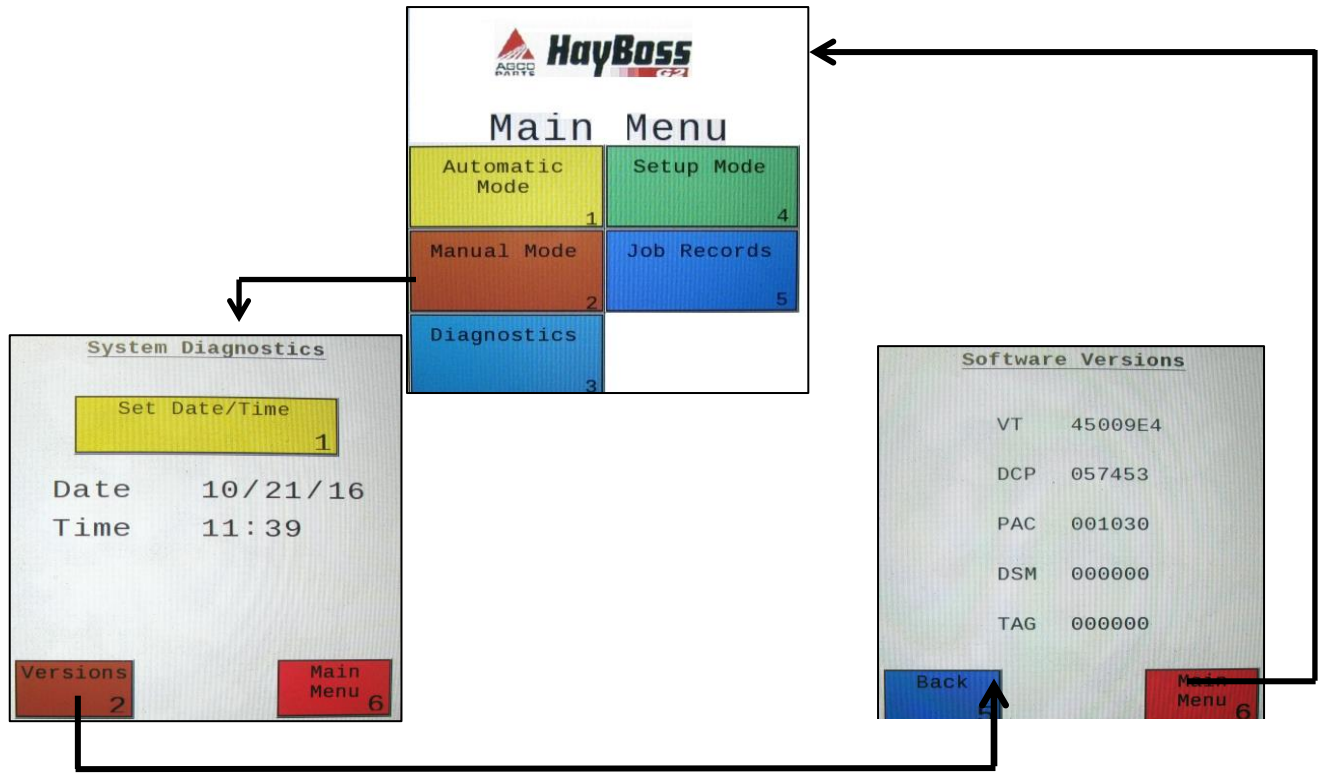

Setup Mode:

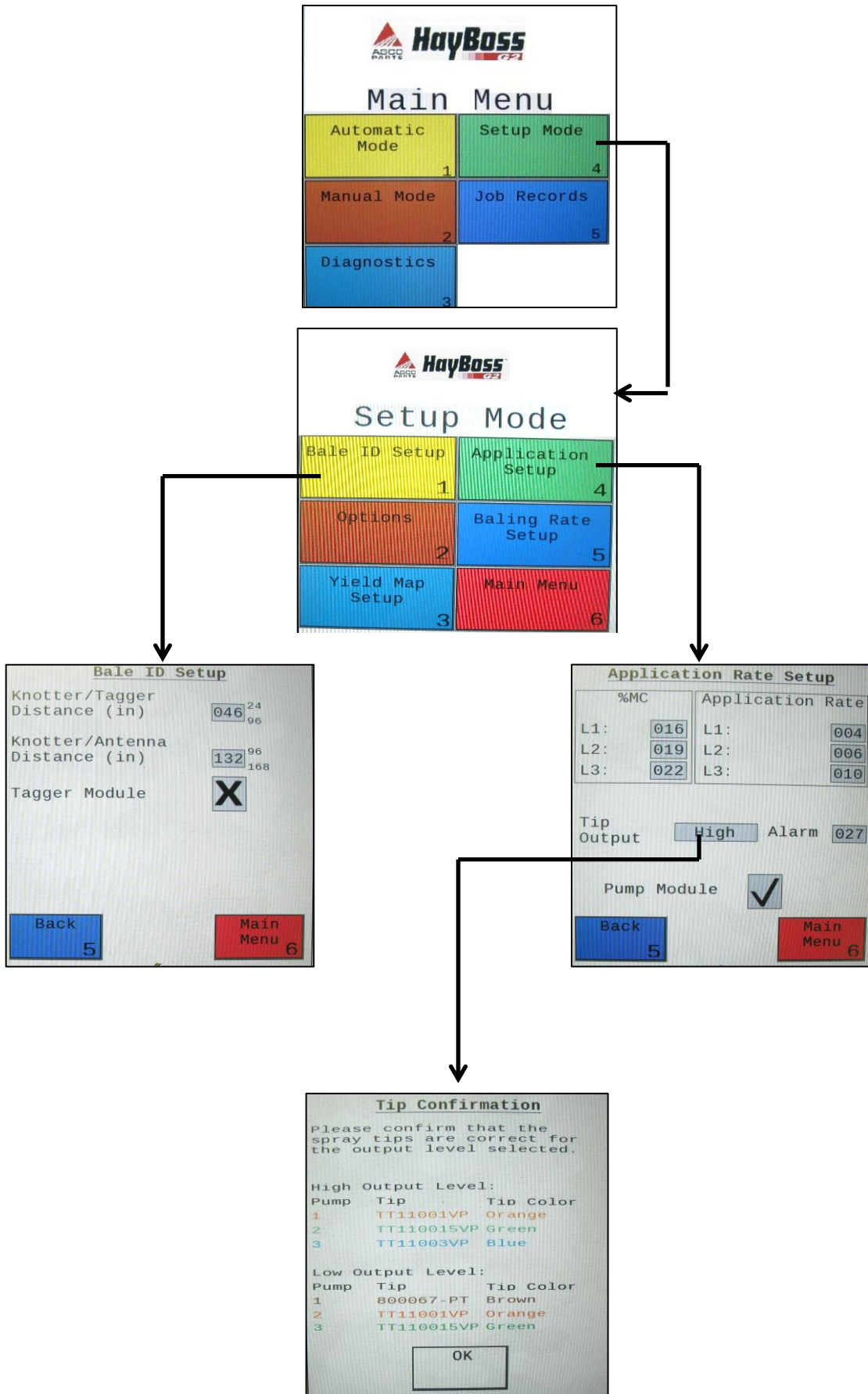

Setup Mode (continued):

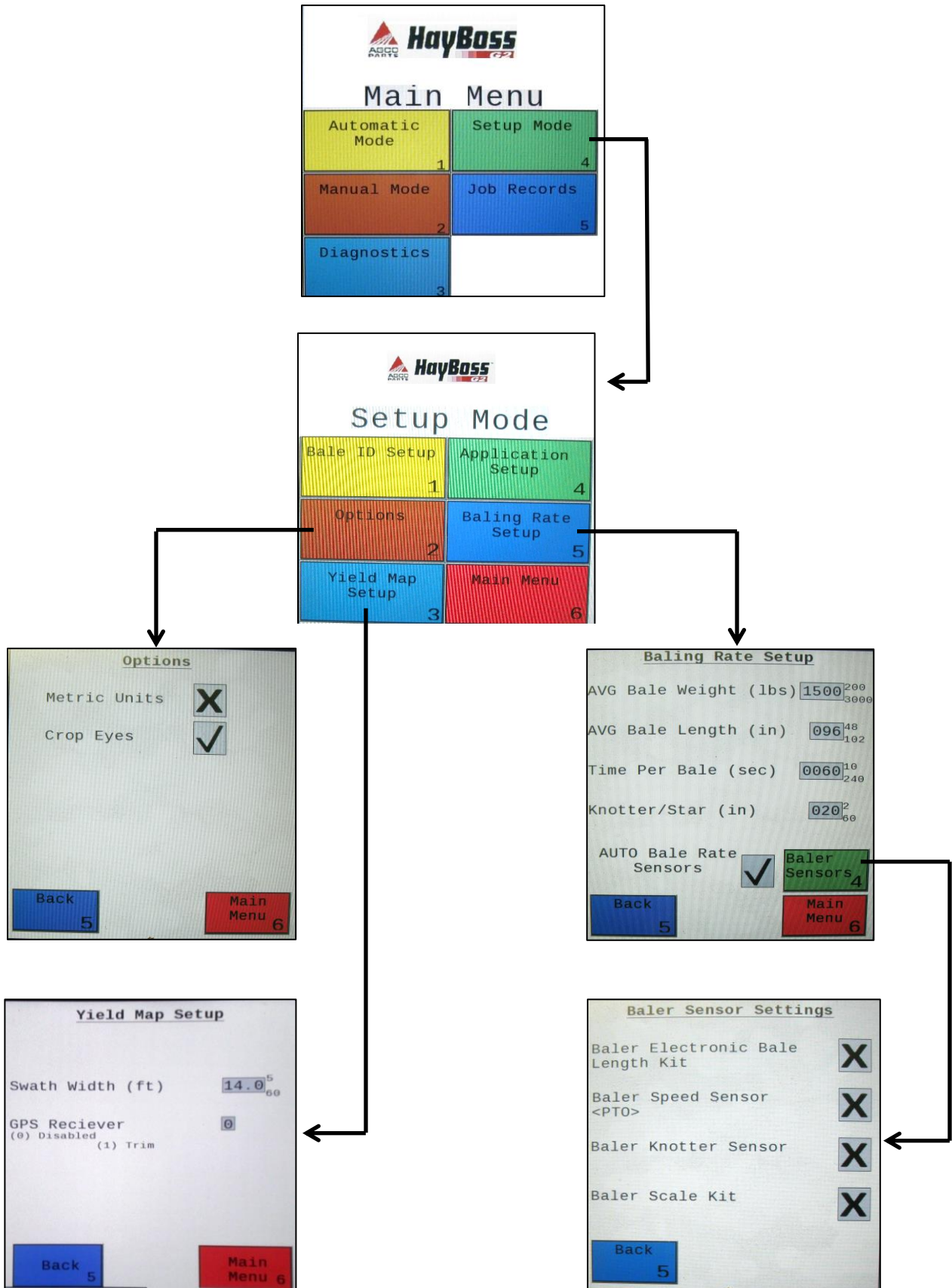

- All baler sensors need to be turned OFF.
- If a scale is being used, turn that sensor ON.



**Job Records:**

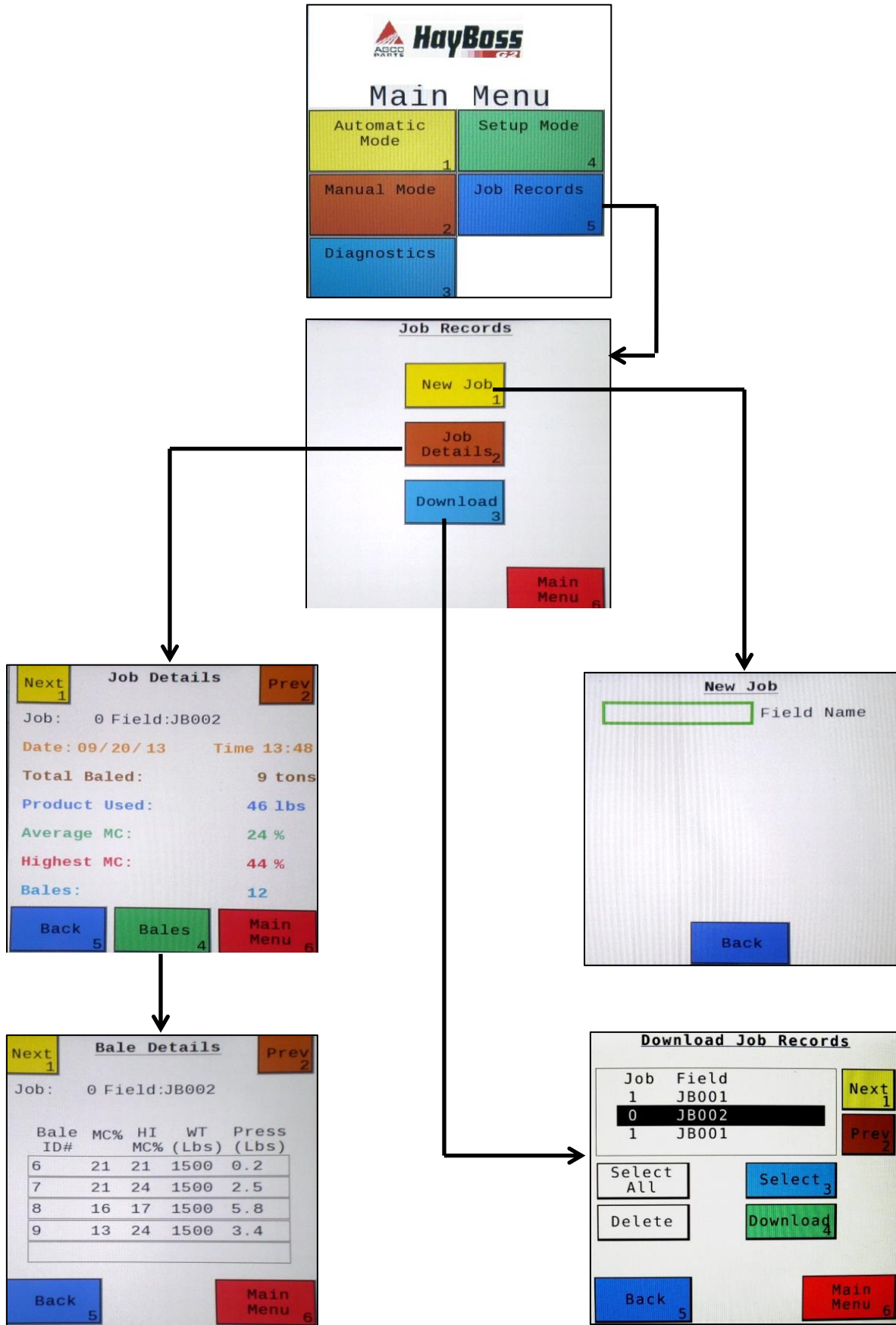

## First Time and Annual Start Up Instructions

### Checking and Priming the Pumps

- Put 10 (5L) gal of water in tank and turn main ball valve on.
- Inspect for any leaks or drips at this time. If any are found tighten or replace area or fitting.
- Turn controller ON (turn key ON to the tractor).
- Press the **SETUP MODE** key. Select **AUTO Baler Rate** sensors **OFF** (A) to disable bale rate sensors. Make sure the **AVG Bale Weight** (B) is 1500 lbs (680kg) and the **AVG Baler Length** (C) is 96" (243cm) and **EST Baling Time** (D) is 60 sec. Press **MAIN MENU** (E) key to return to opening screen.
- Press the **MANUAL MODE** key.
- The screen shown below and to the right should appear.

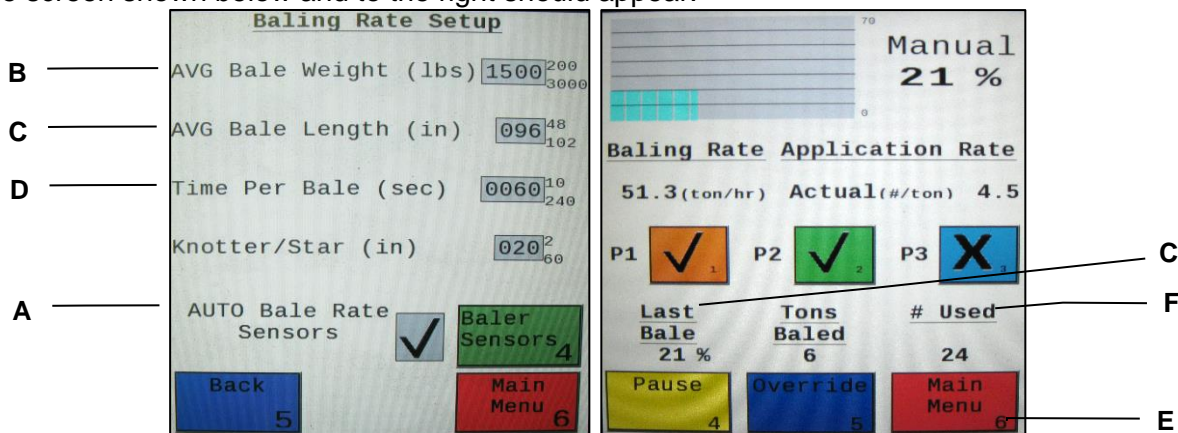

- NOTE: the system comes with the High tips already installed on the spray shield. Test the system with the tips you will use most often.** The rates listed below are for Harvest Tec buffered propionic acid. Other products will need to be collected and weighed to assure proper performance.

Pump	Low Output (Lbs / Ton) (L/MT)	High Output (Lbs / Ton) (L/MT)
1	1.1 – 1.5 (.5 - .7L)	1.9 – 2.6 (.9 - 1.2L)
2	1.9 – 2.6 (.9 - 1.2L)	2.9 – 3.9 (1.3 - 1.8L)
3	2.9 – 3.9 (1.3 - 1.8L)	5.7 – 7.7 (2.6 - 3.5L)

- This process will also be used to prime the pumps whenever needed.
- While running pumps check for a good spray pattern out of the respective tips and verify that no parts of the system are leaking.
- While doing these tests the **# Used** (Volume Used) near the bottom of the screen (F) should be counting up and verifies that the flow meter is functioning.
- Last Bale** (G) shows the average moisture content of the last bale made. This information will then be saved in your **Job Records**.
- Press the **MAIN MENU** (E) key to return to the initial start up screen.

NOTE: After completing First Time and Annual Start Up press the **SETUP MODE** key and turn the **AUTO Bale Rate** sensors back **ON** for normal operation. In normal operation it is recommended that the system be run with the **AUTO Bale Rate** sensors **ON**. Also see Baling Rate to adjust bale weight, length, and time.

### Setting up Application Rate and Bale Parameters for Initial Use

In this mode you will setup your initial application rate and baling rate.



## Setting Up Application Rate and Bale Parameters for Initial Use

In the SETUP MODE you will set your initial application rate and baling rate.

### Application Rate Setup

After pushing the **SETUP MODE** key in the **MAIN MENU** screen, the top left screen will show on the display:

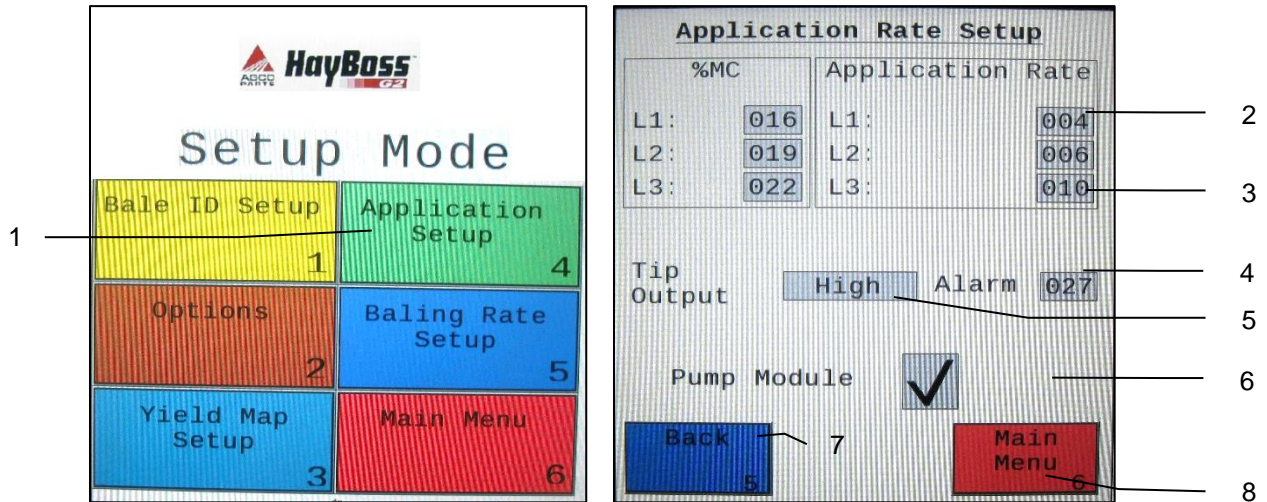

1. On this screen the operator will press the **APPLICATION SETUP** (1) key.
2. Press any of the underlined numbers to the right of **%MC** (2) to adjust their figures. Remember level 1 must be lower than level 2 and level 2 must be lower than level 3. Harvest Tec products recommend set points of 16, 19 and 22% MC levels. These are preset from the factory.
3. To change **Rate** (3) of chemical application press any of the underlined numbers to the right of **RATE**. Remember level 1 must be lower than level 2 and level 2 must be lower than level 3. Harvest Tec products recommend rates of 4, 6, and 10 lbs/ton (2,3,5 L/MT). These rates are preset from the factory. Press **Back** (7) to return to previous screen. **IT IS THE OPERATORS RESPONSIBILITY TO FOLLOW RECOMMENDATIONS OF PRESERVATIVE. ONLY THE OPERATOR CAN APPLY PROPER RATE.**
4. To set the **Alarm** (4) press on the underlined area and set the level at which you want the alarm to activate. **To turn the Alarm OFF, set level above 80.**
5. Press the underlined area next to **Tip Output** (5) to cycle between the High and Low sets of tips. The High tips will cover outputs of 84-632 lbs/hr at approximately 21-63 tons/hr. The Low tips will cover outputs of 44-400 lbs/hr at approximately 11-40 tons/hr. Use the correct tip set for the field conditions.
6. The **Pump Module** (6) needs to be turned **ON** for the pumps and flow meter to function.
7. Next press the **Back** (7) key found on the bottom left hand side of the screen to return to **SETUP MODE** screen or press the **MAIN MENU** (8) key to return to the opening screen.

### Tip Outputs

#### High Output Tips for Rates Requiring 84-632 lbs/hr. (Approximately 21-63 tons/hr)

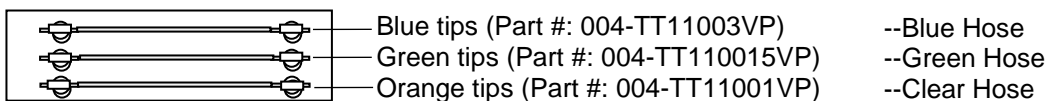

#### Low Output Tips for Rates Requiring 44-400 lbs/hr. (Approximately 11-40 tons/hr)

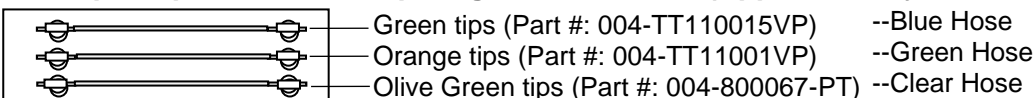

## Baling Rate Setup

After pushing the **SETUP MODE** key in the **MAIN MENU** screen, the top screen should appear:

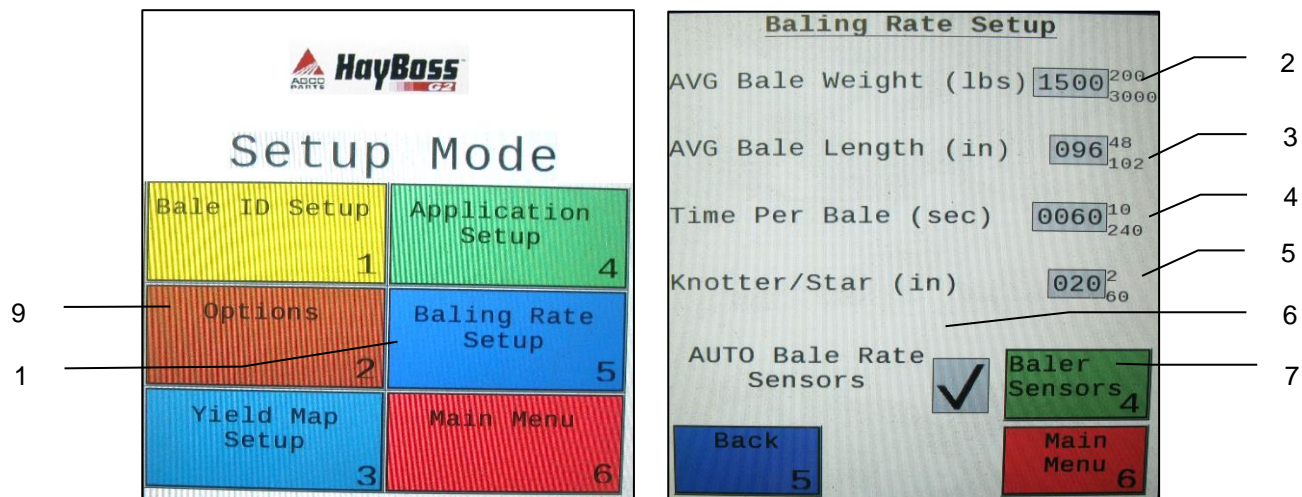

1. On this screen the operator will Select the **BALING RATE SETUP** (1) key.
2. Select the number to the right of **AVG Bale Weight** (2): to adjust the weight of your bales. The key pad shown will display. Select any number combination in this screen within the min/max limits. The information will remain until it is changed again.
3. Select the number to the right of **AVG Bale Length** (3): to adjust the length of your bales. Select any number combination in this screen within the min/max limits. The information will remain until it is changed again.
4. Select the number to the right of **Time Per Bale** (4): to adjust the time it takes to make a bale. Select any number combination in this screen within the min/max limits. The information will remain until it is changed again.
5. Select the number to the right of **Knotter/Star** (5) to adjust the distance between the knotter and star wheel. To determine the distance, measure between the center of the starwheel and the center of the knotter. This is important so the job record correlates to the bale being made.
6. When the **AUTO Bale Rate** (6) sensors are **ON** the applicator will calculate your tons per hour automatically. When the **AUTO Bale Rate** sensors are **OFF** a constant tons per hour (your inputed bale weight and time) will be used. Operating the unit with the **AUTO Bale Rate** sensors **OFF** will cause total tons per hour in Job Records to be left blank. Select the underlined word to toggle between ON or OFF. **First Time and Annual Setup is checking with AUTO Bale Rate sensors OFF.**
7. Selecting the **Sensors** (7) will allow you to use the Baler Sensor if your baler is equipped with them from the factory. The sensors will come OFF as a default. If you choose to use the baler sensors be sure your baler is equipped with that option. For example, if you do not have an electronic bale length kit, turn the sensor to OFF. The baler End of Row sensors are triggered once the PTO speed goes below 600RPM. The End of Bale sensor is triggered by the tie cycle alarm. The Bale Scale sensor is for the baler equipped with a Chute Scale. **Note: Baling on rough terrain or hills can cause the scale to give an inaccurate reading. Turn Bale Scale option OFF in the Bale Rate Screen and use AVG Bale Weight (2) reading as weight of bale.**
8. Next select the **Back** (8) key found on the bottom left hand of the screen to return to the **SETUP MODE** screen, or select the **MAIN MENU** (9) key on the bottom right hand of the screen to return to the opening screen.
9. Select the **OPTIONS** (10) key to adjust the system between metric and standard units. The **Crop Eyes** (11) can also be turned **ON** or **OFF** in the **OPTIONS** screen. Select the ON/OFF next to Crop Eyes to change this setting. **Note: If you change languages you may need to reset the system from the MAIN MENU screen.**

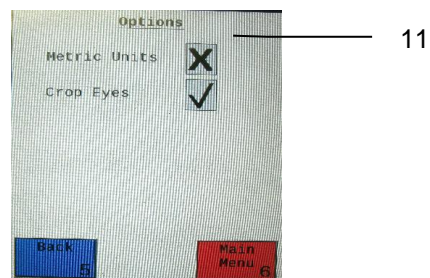

## Operating Instructions

Automatic Mode will automatically apply product based on both hay moisture content sensed by the star wheels and the operator's preset parameters. See **Setting Up System for Initial Use** to change any of these settings. **Manual Mode will apply preservative to the hay at a fixed rate regardless of the moisture content or baling rate.**

### Automatic Mode

After pushing the **AUTOMATIC MODE** key in the **MAIN MENU** screen, the following screen should appear:

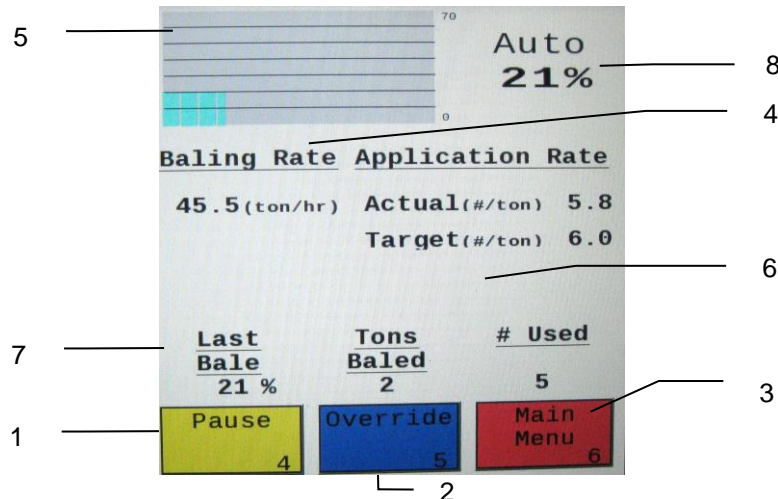

1. Push the **Pause** key (1) to stop application while in operation.
2. Push the **Override** key (2) to turn on all three pumps at the same time for full output of the system. Use this mode when going through a short area of wet crop.
3. The **Moisture Content** (3) is shown in the upper right hand corner.
4. **Baling Rate** and **Application Rate** (4) are shown in the middle. The operator sets the target application rate in the **SETUP MODE**. The ACTUAL rate should be within +/- one pound when running. The Baling Rate is also calculated in the **SETUP MODE**.
5. The **Graph** (5) shows the moisture trend from the past 90 seconds in 3 second intervals.
6. The totals on the bottom of the screen show the total **Tons Baled** and **# Used** (pounds of product used) (6) for the current job. These numbers will reset to zero when a new Job Record is started. If operating with Bale Rate Sensors OFF total Tons Baled will be zero.
7. **Last Bale** (7) shows the average moisture content for the last bale.
8. Any Status Alerts for the system will appear in the middle of the screen. See the Status Alerts section for information.
9. Press the **MAIN MENU** (8) key to return to the opening screen.

## Manual Mode

After pushing the **MANUAL MODE** key in the **MAIN MENU** screen, the following screen should appear:

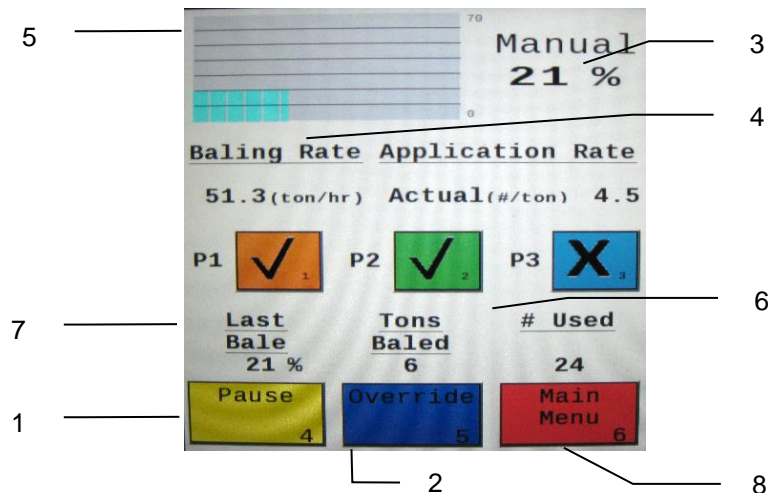

1. Push the **Pause** key (1) to stop application while in operation.
2. Push the **Override** key (2) to turn on all three pumps at the same time for full output of the system. Use this mode when going through a short area of wet crop.
3. In **MANUAL MODE** you can turn the pumps **ON** or **OFF** by pressing the underlined area next to the pump numbers. In **MANUAL MODE** (regardless of moisture, tons per hour or bale weight) the outputs of the pumps are fixed rates as follows:

### Low output tips:

Pump 1 = 60 LBS/HR  
Pump 2 = 100 LBS/HR  
Pump 3 = 150 LBS/HR

### High output tips:

Pump 1 = 100 LBS/HR  
Pump 2 = 150 LBS/HR  
Pump 3 = 300 LBS/HR

4. The **Moisture Content** (3) is shown in the upper right hand corner.
5. **Baling rate** and **Application rate** (4) are shown in the middle. The output of a pump can be checked by dividing the preset output (shown in step 3) by the baling rate. For example, if you have the high output tips in and are running pump three by itself, your output is 300 lbs/hr. Given the Baling Rate (4) shown on the above screen (79.5 tons/hr), the application rate should be about 3.77 lbs/ton (300lbs/hr divided by 79.5 tons/hr).
6. The **Graph** (5) shows the moisture trend from the last 90 seconds of baling (one reading every 3 seconds).
7. The Totals at the bottom of the screen show the total **Tons Baled** and **# Used** (pounds of product used) (6) for the current job. These numbers will reset to zero when a new Job Record is started. If operating with AUTO Bale Rate sensors OFF total tons baled will be zero.
8. The **Baling Rate** (4) is set in the **SETUP MODE** menu.
9. **Last Bale** (7) shows the average moisture content for the last bale.
10. Press the **MAIN MENU** (8) key to return to the opening screen.



## Diagnostics

After pressing the **DIAGNOSTICS** key in the **MAIN MENU** screen, the screen on the left should appear:

1. To set date and time select the **Set Date/Time** (1) key. In the next screen enter the date (month, day, year format) followed by the time. When done select the **OK** key (2). NOTE: The clock uses military (or 24 hour) time.
2. Select the **Software Versions** key to check all software versions of modules attached to the Dual Channel Processor (DCP). The information will appear in the screen shown below right.

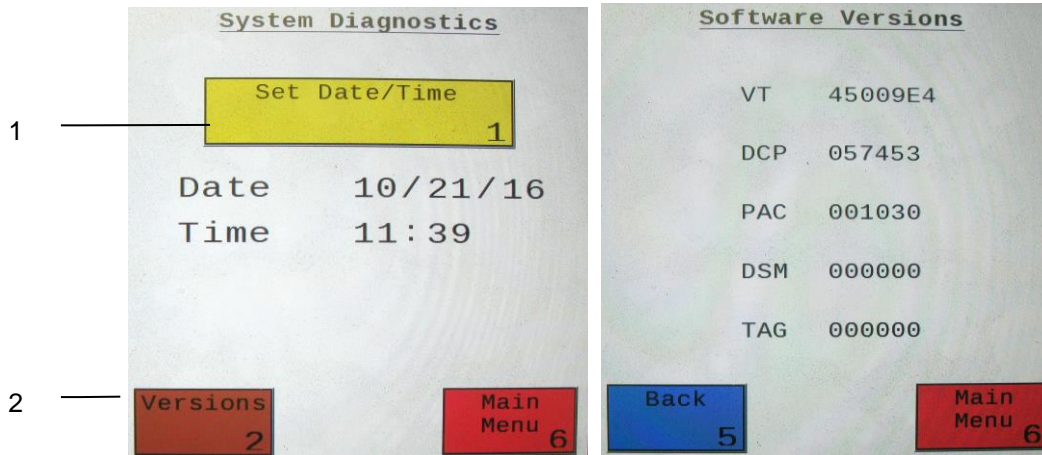

3. Press the **MAIN MENU** (4) key to return to the opening screen.

## Job Records

After pushing the **Job Records** key in the **Main Menu** screen, the following screen should appear:

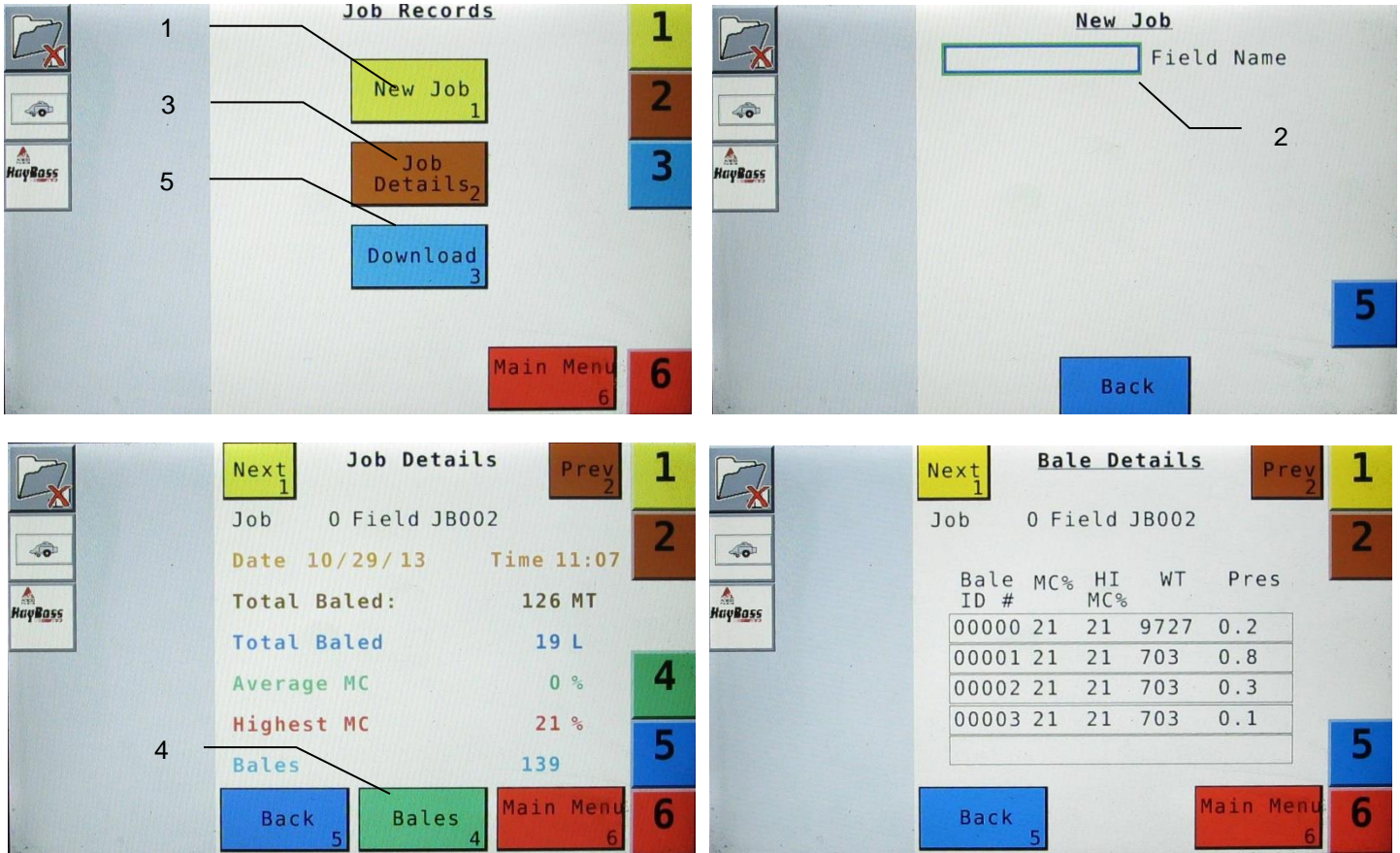

1. Selecting **New Job** will save all the previous bale records and open the **/New Job Field Name** screen.
2. The Keypad will come up when the Field Name is selected enabling entry of up to an eight character field name. When you have completed the field name select **Enter** from the key pad.
3. Selecting **Job Details** will open the Job Details screen. Select the **Next** and **Prev** buttons to scroll through the different jobs. Job 0 will always be your current and open job record. Select **Back** to go to the **Job Records** screen or **Main Menu** for the **Main Menu** Screen.
4. Selecting **Bales** on the bottom of the screen will open a **Bale Details** screen. This screen lets you look at the individual bale records for the first five bales made. Select the **Next** or **Prev** button to scroll through five bales at a time. Select **Back** to go to the Job Details screen or **Main Menu** for the Main Menu Screen.

Continued on the next page

## Job Records (continued)



Microsoft Excel - JB001

JOB DATA							
FIELD	JOB #	AVG MC	HI MC	#USED	BALES	TONS	DATE/TIME
JB001	1	21	55	16	12	8	16 JAN 09 08:32
SALE DATA							
FIELD	JOB #	AVG MC	HI MC	#BALE	BALE ID	BALE WT	DATE/TIME
JB001	1	23	39	1	1.23E+09	1500	16 JAN 09 08:31
JB001	1	27	55	0	9.123E+09	1500	16 JAN 09 08:33
JB001	1	20	24	2	1.23E+09	1500	16 JAN 09 08:34
JB001	1	16	16	0	3.123E+09	1500	16 JAN 09 08:35
JB001	1	21	24	1	6.123E+09	1500	16 JAN 09 08:36
JB001	1	16	24	1	8.123E+09	1500	16 JAN 09 08:36
JB001	1	23	39	1	3.123E+09	1500	16 JAN 09 08:37
JB001	1	27	55	0	9.123E+09	1500	16 JAN 09 08:38
JB001	1	20	24	2	1.23E+09	1500	16 JAN 09 08:40
JB001	1	16	16	0	3.123E+09	1500	16 JAN 09 08:41
JB001	1	21	24	1	6.123E+09	1500	16 JAN 09 08:42
JB001	1	16	24	1	8.123E+09	1500	16 JAN 09 08:43

RYANI - Notepad

JOB DATA							
FIELD NAME	JOB NUMBER	AVG MC	HIGH MC	PRODUCT USED	TOTAL SALES	TOTAL TONS	DATE/TIME
RYANI	00033	00016	00003	0000000397	00012	0000000004	29 DEC 08 12:51
SALE DATA							
FIELD NAME	JOB NUMBER	AVG MC/BALE	HIGH MC/BALE	PRODUCT USED/BALE	BALE ID NUMBER	BALE WEIGHT	DATE/TIME
RYANI	00033	00023	00024	0003.5	0847600718	02600	29 DEC
RYANI	00033	00024	00024	0003.2	0847600719	02600	29 DEC
RYANI	00033	00024	00024	0003.9	0847600720	02600	29 DEC
RYANI	00033	00024	00024	0003.9	0847600721	02600	29 DEC
RYANI	00033	00024	00024	0003.5	0847600722	02600	29 DEC
RYANI	00033	00024	00024	0003.4	0847600723	02600	29 DEC
RYANI	00033	00024	00024	0003.9	0847600724	02600	29 DEC
RYANI	00033	00023	00024	0003.4	0847600725	02600	29 DEC
RYANI	00033	00016	00016	0001.6	0847600726	02600	29 DEC
RYANI	00033	00016	00016	0000.8	0847600727	02600	29 DEC
RYANI	00033	00016	00016	0004.7	0847600728	02600	29 DEC
RYANI	00033	00016	00016	0001.2	0847600729	02600	29 DEC

5. Selecting the **Download** key will open the **Download Job Records** screen. This screen lets you select jobs to download onto a USB drive. To download insert a USB drive into the port on the Dual Channel Processor (DCP). Select the job(s) you would like to download using the **Next** and **Prev** keys and highlight the job(s). An asterisk will appear next to all selected jobs. Once all the jobs are selected, select the **Download** key. Select the **Download** key again to confirm. Once the message on the screen reads **"Finished"** the files have been saved to the USB. The Jobs can then be opened on any computer with Excel or Notepad. To delete jobs highlight and select the desired job and then press **Delete** followed by selecting delete again for confirmation. Select **Back** to go to the Job Records screen or select Main Menu to go to the Main Menu screen.
6. Choosing the **Select** key will select or unselect the highlighted job.
7. Choosing the **Select All** key will select all jobs, except for the current job (0). To unselect Select the Back key.
8. The Job Record in Excel will show as above on the left. The Bale ID column will need to be adjusted for proper viewing.
9. The Job Record in Notepad will show as above on the right. You will need to move right to see all the information.



## Common Questions

**1. How do I turn the system on/off?**

Turn the key in the tractor to the ON/OFF position.

**2. How to get in the LBS/TON, MC%, and TONS/HR menus?**

In the Main Menu Select the SETUP MODE key. From this screen you can change your application rates and how much product is applied. See SETTING UP FOR INITIAL USE for a detailed explanation of this process.

**3. The unit is stuck in the MC% screen.**

In the MC% screen, level 1 must be less than level 2, and level 2 must be less than level 3. For example, if level 1 is set at 16, level 2 must be set at 17 or higher, and level 3 must be set higher than level 2.

**4. How does OVERRIDE work?**

Override turns on all three pumps at full output. The pumps will remain at full output until the operator turns these pumps off by selecting the OVERRIDE key again.

**5. The flow meter reading is more or less than the programmed level set in the box.**

Some variation in flow meter readings compared to the programmed set point is normal due to factory tolerances on the pump motors as well as varying tractor voltages inputted to the control box. The flow meter reading is an accurate measure of how much product is actually being applied. The set points then will need to be adjusted if you want to attain a different flow meter reading.

**6. Why don't all the pumps turn on even at higher application rates?**

The selections of what pumps turn on when are automatically controlled by the control box's flow rate look up chart. Thus, not all the pumps turn on at once and the combination of what pumps turn on when is automatically controlled by the software. If you want to make sure all three pumps are working, go to the Diagnostics screen and run pump outputs.

**7. The moisture content displays "LO" or "HI" all the time.**

When the moisture content display does not change frequently while baling, there is likely a faulty star wheel connection. One of the first places to check is inside the white star wheel block. Check to see if the electronic swivel is in the star wheel shaft and check to see that the star wheel shaft is not working out of the block. Also, check all star wheel wires and connectors to see if there is a continuity or grounding problem.

**8. Should the battery connections be removed before jump starting or charging a battery?**

Yes. Anytime the tractor will have voltage going up rapidly the connections should be removed.

**9. How can I turn the optional Hay Indicators on/off from the cab?**

In the Setup Mode screen select Options. Select the ON/OFF underlined area next to Crop Eye Sensors.

**10. Bale scale does not give a consistent reading.**

Baling on rough terrain or hills can cause the scale to give an inaccurate reading. Turn Bale Scale option OFF in the Bale Rate Screen and use AVG Bale Weight reading as weight of bale.

**11. What do the lights on the 030-6672B indicate?**

Pre-2020 applicators were equipped Bluetooth receivers (030-6672B) and are now equipped with lights to indicate both power and Hay App connection on the Apple iPad. Red Light – The Bluetooth receiver has power. Green Light – The Bluetooth receiver is connected to the Hay App.

## iPad Integration Control Module

030-6672C

To operate the applicator, connect the iPad cord to the iPad Integration Control in the port indicated by:

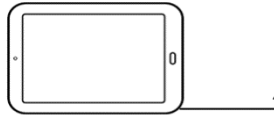

## iPad Integration Control Light Signals

Green Slow Blink – Power supplied to the applicator system and the unit is going through its startup process. This will take approximately 25-35 seconds.



Green Double Blink – Indicating the iPad module recognizes the iPad but the app is not open or connected.

Green Solid Light – Module is connected to the app and is ready to operate.

\*Recommended to use the USB cable included with the applicator kit (006-6672USBC)

## Bluetooth Receiver Lights

Pre-2020 applicators equipped with Bluetooth receivers (030-6672B) are now equipped with lights to indicate both power and Hay App connection on the Apple iPad. Clean light regularly

*Blinking Lights* – System is waiting for the processor to connect, which could take up to 35 seconds.

*Red Light* – The Bluetooth receiver has power

*Green Light* – The Bluetooth receiver is connected to the Hay App.



**\*\*600 Series Applicators with serial number before DCP27000 will require the DCP to be sent to Harvest Tec for a required update in order to use the iPad Integration Module (030-6672C).**

Hay App version must be **at least 2.5.18 (or higher)** to operate with the iPad Integration Module

## \*Made for Apple iPad badge

Use of the Made for Apple iPad badge means that an accessory has been designed to connect specifically to the Apple product(s) identified in the badge and has been certified by the developer to meet Apple performance standards. Apple is not responsible for the operation of this device or its compliance with safety and regulatory standards.

Please note that the use of this accessory with an Apple product may affect wireless performance.

## Maintenance Schedule

	Daily	10 hrs	400 hrs	Weekly	Monthly	Season
Diagnostics	X					X
Filter bowl cleaning		X				X
Tips & tip screen cleaning		X				X
Tank lid cleaning		X				X
Dielectric grease connections					X	X
Rebuild pumps			X			
Battery connections				X		X
Check valves			X			
Visually inspect hoses				X		X

**Diagnostics:** Is used for setting the date and confirming the Version.

**Filter Bowl Cleaning:** The filter bowl is located in front of the applicators tank and is connected to the ball valve. Before cleaning the filter bowl all personal protective equipment must be worn (Face shield or goggles, chemically resistant apron, boots, and gloves).

Verify that the ball valve located next to the pump is turned off. Locate the filter bowl on the side of the pump manifold (A). Unscrew the bottom section of the filter bowl and remove the strainer. (B) Clean off any debris and soak in warm water with a mild soap if necessary. Once the screen is clean reinstall by following the directions in reverse.

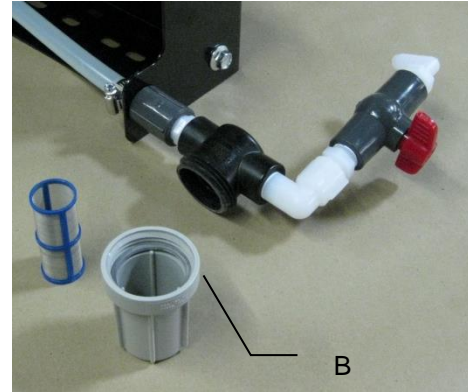
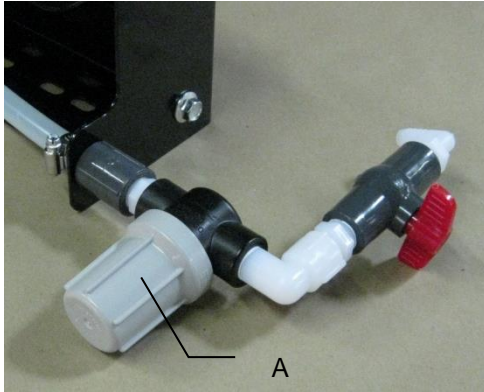

**Tips and Tip Screen Cleaning:** The spray shield assembly that holds the tips and tip screens is located above the pickup head.

Before cleaning the tips and screens all personal protective equipment must be worn (Face shield or goggles, chemically resistant apron, boots, and gloves).

Verify that the ball valve located next to the pump is turned off. Disconnect spray shield from hangers by removing the lynch pins (A). Disconnect check valve nuts and remove hoses from shield (B). Remove shield from baler. Remove all six nozzle caps with a 7/8 inch wrench (C). Hold the nozzle body from turning while removing the nozzle caps with a 11/16 inch wrench. Remove the tip, and screen. Clean off any debris and soak in warm water with a mild soap if necessary. Once the tips and screens are cleaned reinstall by following the directions in reverse.

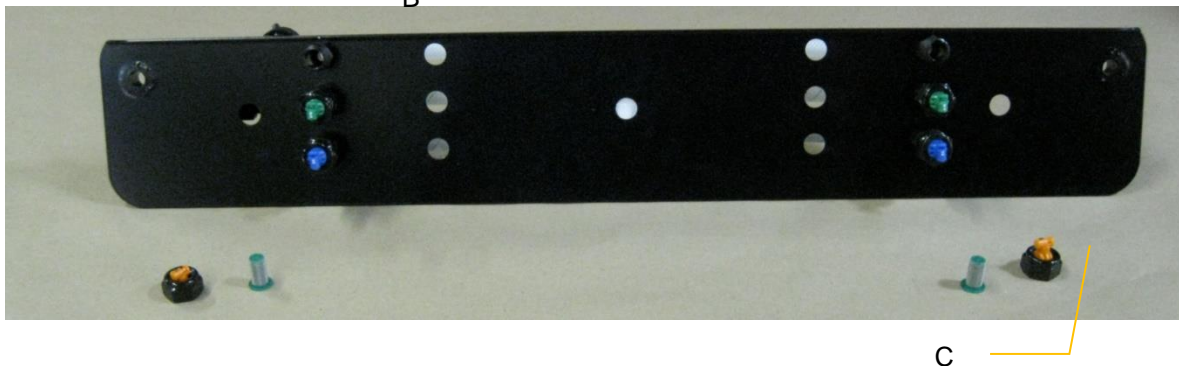

**Tank Lid Cleaning:** Before cleaning the tank lid all personal protective equipment must be worn (Face shield or goggles, chemically resistant apron, boots, and gloves).

The tank lid is located on the top of the tank. Use the supplied handle on the tank to secure your person and use the other hand to remove any debris from the top of the tank. Unscrew the tank lid and bring down ground level. Use compressed air clean out the tank breather (D). Once the breather is cleaned reinstall the cover.

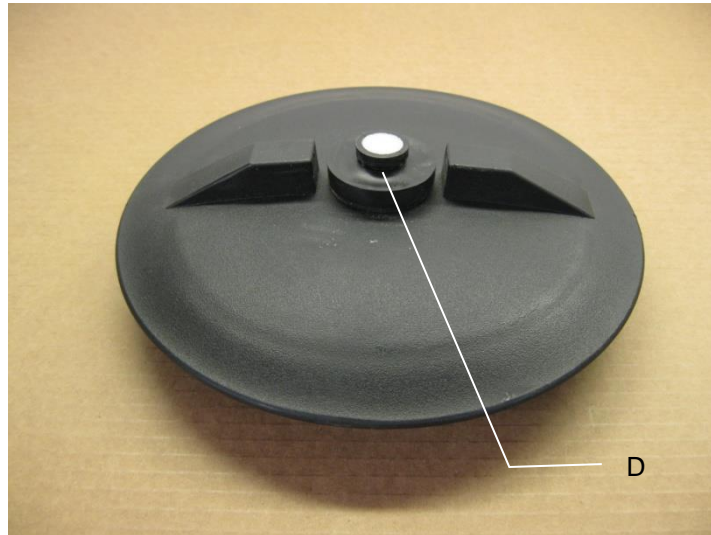

**Dielectric Grease Connections:** Disconnect all harnesses on the applicator, clean the connections, and repack with dielectric grease.

**Rebuild Pumps:** If Diagnostic or Manual mode show that the pumps are running lower than normal, a pump rebuild may be necessary. To do this rebuild the pump must be removed from the pump manifold. Pump rebuild is part no. 007-4581. A service pack that includes pump rebuilds and check valves is available from your local dealer.

Verify that the ball valve is turned off. Before working around the pumps all personal protective equipment must be worn (Face shield or goggles, chemically resistant apron, boots, and gloves). Remove pump from manifold. Follow rebuild instructions supplied with pump rebuild kit. Reinstall after rebuild is complete.

**Battery Connections:** Follow the batteries safety warnings and clean the battery connections. If the connections cannot be cleaned, replace harness.

**Check Valves:** Before servicing the check valves all personal protective equipment must be worn (Face shield or goggles, chemically resistant apron, boots, and gloves).

Verify the ball valve is turned off before service the check valves. Replace the intake check valves by the pumps (002-4566F) and the discharge check valves by the tip (004-1207VB).

#### **Miscellaneous Maintenance:**

1. Depending on the product being used, the system may need to be flushed with water at a regular interval (consult with manufacturer of the chemical.) If Harvest Tec product is being used, flushing is not necessary.
2. Although the pump can run dry, extended operation of a dry pump will increase wear. Watch the preservative level in the tank.
3. If you are using bacterial inoculants, flush your system daily after every use.

## Winter Storage

1. Thoroughly flush the system with water.
2. Remove the filter bowl and run dry until the water has cleared out of the intake side.
3. Remove the red plug from the bottom of the pump, drain, and run the pump for 30 seconds or until dry.
4. Drain all lines on the outlet side.
5. Never use oils or alcohol based anti-freeze in the system.
6. For spring start-up, if the pump is frozen, turn off the power immediately to avoid burning the motor out or blowing a fuse. The pump head can be disassembled and freed or rebuilt in most cases. Check the fuses after the pump has been freed.
7. Disconnect power from the Precision Information Processor.
8. Remove display from tractor and store in a warm, dry place.

## Status Alerts

Two Status Alerts will appear on the Auto and Manual mode screens when the Job Records are approaching, or full of records.

Status Alert “**Bale Records: Less than 1K remaining**”. The system is now approaching the maximum amount of records that can be saved. When this code appears, download and delete jobs in the Job Records menu. Follow the instructions in Job Records to accomplish this.

Status Alert “**Bale Records failed – Memory Full**”. The system will no longer accept any new data until jobs in the Job Records menu are downloaded and deleted. Follow the instructions in Job Records to accomplish this.

## Troubleshooting

<b>PROBLEM</b>	<b>POSSIBLE CAUSE</b>	<b>SOLUTION</b>
Pump will not run.	1. No voltage to DCP or Pump controller.	1. Check for short, low voltage, and replace fuse(s) if necessary.
	2. Pump locked up.	2. Clean or rebuild pump if motor is OK.
	3. Damaged wire.	3. Repair damaged wire.
	4. Fuse blown on Pump controller.	4. Replace fuse and check pump for short in wire or locked motor.
Pump runs but will not prime.	1. Air leak in intake.	1. Tighten fittings on intake side.
	2. Clogged intake.	2. Clean.
	3. Restricted outlet.	3. Check and clean tips.
	4. Check valve on the outlet is stuck closed.	4. Clean or repair check valve.
	5. Dirt inside pump.	5. Replace pump check valve.
Pump does not develop enough output.	1. Air leaks or clogs on inlet side.	1. Tighten or clean filter bowl assembly.
	2. Pump worn or dirty.	2. Rebuild pump.
Moisture reading errors (high or low)	1. Wire disconnected or bad connection between star wheels and DCP	1. Reconnect wire.
	2. Low power supply to DCP	2. Check voltage at box. (Min of 12 volts required.)
	3. Wet hay over 75% moisture	
	4. Ground contact with one or both star wheels and baler mounted processor.	4. Reconnect.34-
	5. Short in wire between star wheels and DCP.	5. Replace wire.
	6. Check hay with hand tester to verify.	6. Contact Harvest Tec if conditions persist.
Moisture readings erratic.	1. Test bales with hand tester to verify that cab monitor has more variation than hand tester.	
	2. Check all wiring connections for corrosion or poor contact.	2. Apply dielectric grease to all connections.
	3. Check power supply at tractor. Voltage should be constant between 12V and 14V	3. Install voltage surge protection on tractors alternator.
Flow meter readings do not match up with product usage.		
Product is less than actual product used.	1. Voltage supplied to meter is less than 6 volts.	1. Check for a min of 6 volts supplied at Pump controller.
	2. Wiring short in signal to Pump Controller.	2. Inspect wire and replace if necessary.
	3. Clog in meter.	3. Back flush with water. DO NOT USE AIR.
	4. Air in flow meter	4. Prime all pumps to remove air
	5. Using product other than Harvest Tec	5. Catch and weigh product to check outputs.
Product shown is more than actual product used.	1. High voltage supplied to meter.	1. Check voltage at Pump controller. Max of 18 volts.
	2. Light interference with meter.	2. Reflection into meter can cause a high reading. Move meter or protect from sunlight.
	3. Air leak in intake.	3. Look for air bubbles in line. Replace line or other defective area that is allowing air into the system.
	4. Using product other than Harvest Tec	4. Catch and weigh product to check outputs.



System leaks product out of tips after shut down.	1. Dirty or defective check valves.	1. Clean or Replace.
Terminal reads under or over power.	1. Verify with mult-meter actual voltage. Voltage range should be between 12-14 volts.	1. Clean connections and make sure applicator is hooked to battery. See Diagnostics section of manual.
System does not pause at the end of a row.	1. Short in cable. 2. Damaged sensor. 3. Bad alignment of sensors	1. Replace cable. 2. Replace sensor 3. Check 474 manual for alignment inst.
Bale rate displays zero.	1. Bale rate sensors are reversed. 2. Short in cable or damaged	1. Switch the sensors next to the star 2. Replace cable or sensor
Display says PAC error	1. The DCP and Pump controller are not communicating. 2. Broke connection between the display and DCP or PAC and DCP	1. Check all connections at DCP and Pump controller including terminating resistors. 2. Check, clean, and tighten connections.
Bale scale not giving accurate reading	Load cell calibration is off	1. Refer to your scale owner's manual for instructions on recalibrating.
Error Code 415: Harvest Tec Online	Harvest Tec is communicating with the baler, but Harvest Tec option is not turned on in baler software	Turn harvest Tec option on. See Baler Monitor Setup section
Error Code 416: Harvest Tec Not Detected	Harvest Tec option is turned on, but no communication between the baler and DCP is happening	Check for nozzle icon in top right corner (right). Power cycle DCP only if icon not visible. 
Background of moisture container is red on main baler work screen	Communication error between DCP and AGCO ECU	Enter Auto / Manual mode, verify that no moisture reading has occurred. Then Power cycle DCP only
Moisture container only reads 0/0% when HT system is reading correctly	Communication error between DCP and AGCO ECU	Enter Auto / Manual mode, verify that no moisture reading has occurred. Then Power cycle DCP only
No "HT preservative" option to select on the baler run screen	Harvest Tec PAC is turned off	Turn PAC on. See setup mode section
Job records are showing as symbols or incorrect values	The job file is corrupted on SD card	Write down all job record information the operator wishes to keep. Update the DCP software to the most current version available on the Harvest Tec website. Delete all existing jobs by selecting all in the download screen and pressing delete. Be sure to start a new job and verify it is saved by checking job details screen.
Values in auto / manual mode are obscure	The job file is corrupted on SD card	
Can't download job records, stuck at "Saving to USB Stick"	One of more jobs are corrupted on SD card. If "saving to USB" is displayed, some jobs have been downloaded correctly.	
Can't download job records, stuck at "Searching"	If searching is displayed then the first job is corrupted and download will not work.	
No green baler sensors button in bale rate setup screen	DCP is not configured to communicate with baler	
Bale rate goes to zero and prox sensors/star wheels check out fine	DCP is set to use "Bale Rate Sensor" from baler in calculation and baler does not have installed	Turn off Bale Rate Sensor in baler sensors screen, make sure Auto baling rate is turned on in baling rate setup
"Cannot open USB" message when trying to download	DCP does not see a USB stick in the Data Transfer port	Make sure the operator has the USB in the DCP with good connect and not the VT port in the cab of the tractor.
Bluetooth Receiver lights will not illuminate	1. Bluetooth receiver not connected 2. Harness disconnected	1. Check connections and voltage. Minimum 12.5V needed.
	Blinking Lights – System is waiting for the processor to connect, which could take up to 35 seconds. <i>Red Light</i> – The Bluetooth receiver has power <i>Green Light</i> – When the proper active connection is selected in the Hay App menu, the green light will indicate connection with the iPad.	



## Wiring Diagram

- The **Baler Power/Communication Harness** (006-6650LS2(E)) will attach to the open port of the Tractor **Harness** (006-6650TM(E)) and run back to the **Dual Channel Processor** (006-6671LS). Connect the large plug of the Baler Power/Communication Harness (006-6650LS(E)) to the bottom (shorter side) of the DCP.
  - Attach the **Baler Interface Harness** (006-6650VA) in between the short whip cable hardwired to the DCP and the main Power/Communication Harness (006-6650LS2(E)). Make sure Active Terminator removed from the top of the baler processor is attached to Baler Interface Harness (006-6650VA).
  - Install green terminator (006-5650Z) to the port labeled **Modular Port** on the Pump Controller (006-5672).
  - Attach moisture and bale rate harness (006-7303H) as well as the end of bale harness (006-7400) to the DCP (006-6671LS).
  - Attach the Pump Control Harness (006-5650F3M) between the Pump Controller (006-5672) and the DCP (006-6671LS).
  - Connect Keyed Power Extension harness (006-5650K) to a keyed power source.
  - Connect the iPad Integration Control (030-6672C) to the Communication Harness (006-6650TM(E)).
- Note: The Optional Port and the Data Transfer Port are not used in this application.

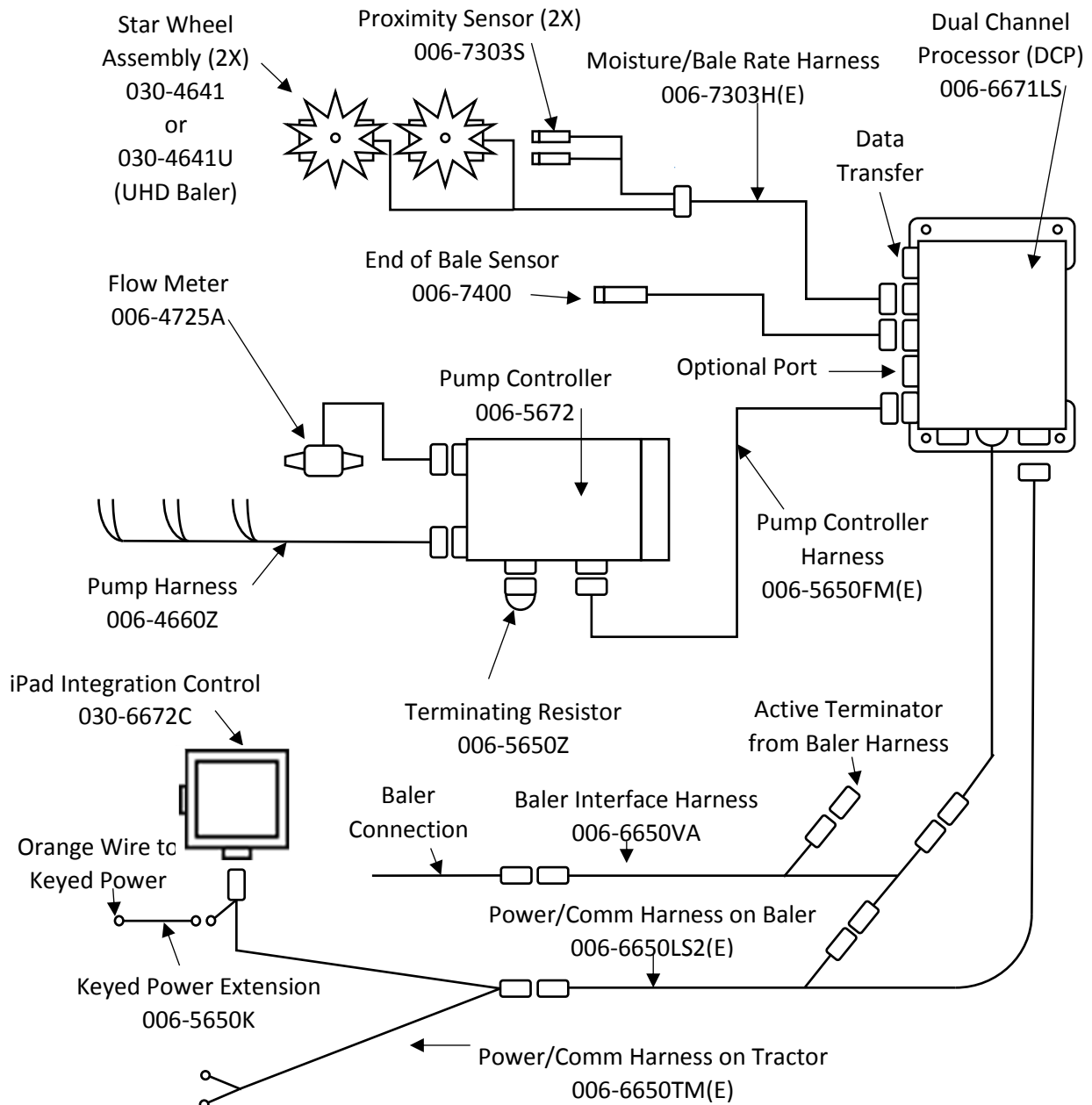

\*AGCO 2100 Series Balers Pre 2012 will need the Integration Harness 006-6650VAX

\*Note: (E) indication is used for International Dealers

## Wiring Diagram

- The **Baler Power/Communication Harness** (006-6650LS2(E)) will attach to the open port of the **Tractor Harness** (006-6650TM(E)) and run back to the **Dual Channel Processor** (006-6671LS). Connect the large plug of the Baler Power/Communication Harness (006-6650LS(E)) to the bottom (shorter side) of the DCP.
  - Attach the **Baler Interface Harness** 006-6650VA or 006-6650VAU (UHD Baler) in between the short whip cable hardwired to the DCP and the main Power/Communication Harness (006-6650LS2(E)). Make sure Active Terminator removed from the top of the baler processor is attached to Baler Interface Harness 006-6650VA or the 006-6650VAU (UHD Baler).
  - Install green terminator (006-5650Z) to the port labeled **Modular Port** on the Pump Controller (006-5672).
  - Attach moisture and bale rate harness (006-7303H(E)) as well as the end of bale harness (006-7400) to the DCP (006-6671LS).
  - Attach the Pump Control Harness (006-5650F3M(E)) between the Pump Controller (006-5672) and the DCP (006-6671LS).
  - Connect Keyed Power Extension harness (006-5650K) to a keyed power source.
  - Connect the iPad Integration Control (030-6672C) to the Communication Harness (006-6650TM(E)).
- Note: The Optional Port and the Data Transfer Port are not used in this application.

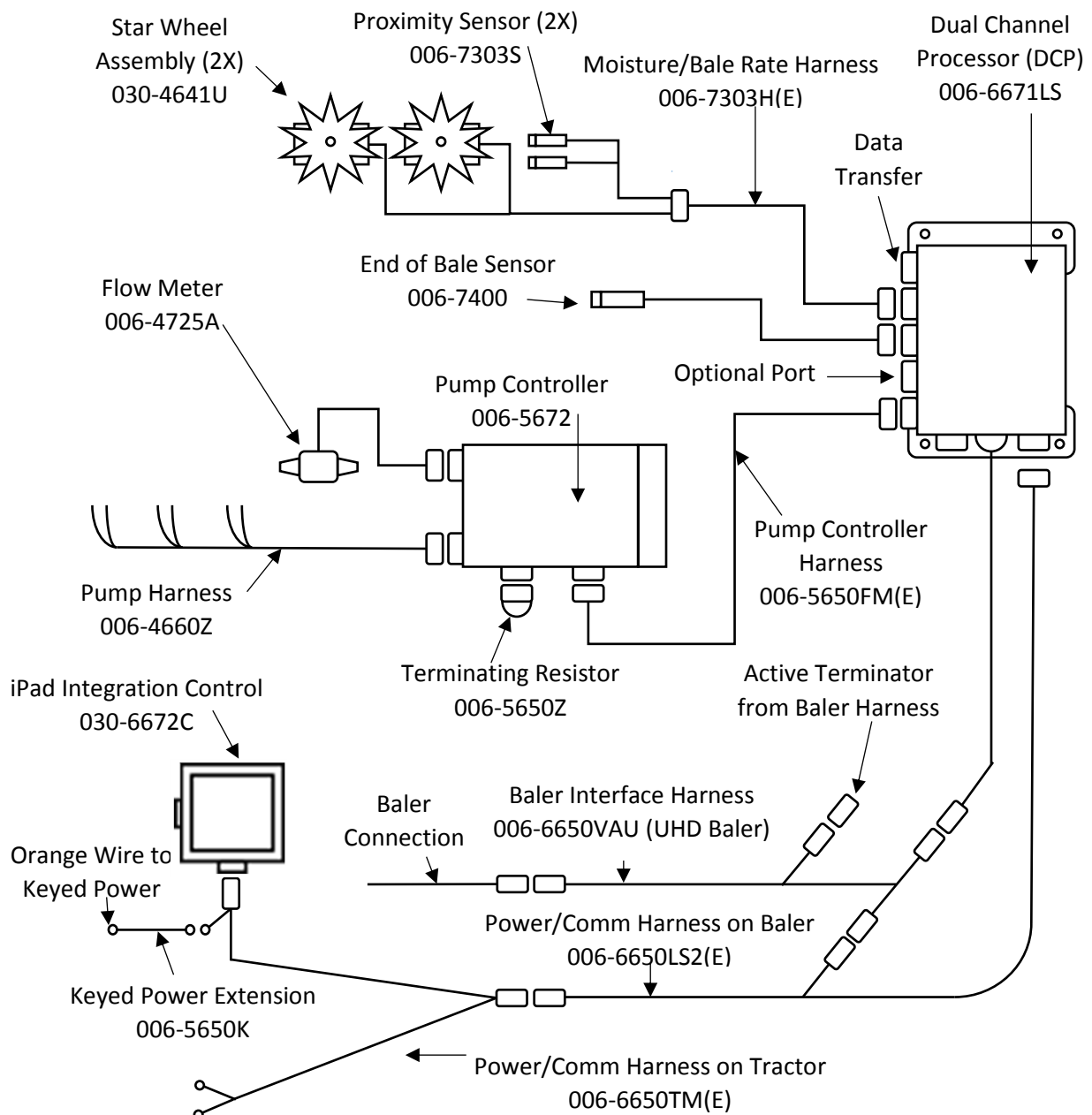

\*Note: (E) indication is used for International Dealers

## Pin Outs

### Power/Comm Harness 006-6650TM at Hitch

Pin 1	Red	+12V Power to TSD
Pin 2	Red	+12V Power to DCP
Pin 3	Orange	Keyed Power
Pin 4	Gray	Shield
Pin 5	Green	HT Can Low
Pin 6	Yellow	HT Can Hi
Pin 7	Orange	Can1 Hi
Pin 8	Black	Ground from TSD
Pin 9	Black	Ground from DCP
Pin 10	Blue	Can1 Low



### Power/Comm Harness 006-6650LS2 at Hitch

Pin 1	Red	+12V Power to TSD
Pin 2	Red	+12V Power to DCP
Pin 3	Orange	Keyed Power
Pin 4	Gray	Shield
Pin 5	Green	HT Can Low
Pin 6	Yellow	HT Can Hi
Pin 7	Orange	Can1 Hi
Pin 8	Black	Ground from TSD
Pin 9	Black	Ground from DCP
Pin 10	Blue	Can1 Low



### iPad Integration Control / BLE Harness 006-6650TM

Pin 1	Red	+12V Power from DCP
Pin 2	Black	Ground from TSD
Pin 3	Yellow	HT Can Low
Pin 4	Gray	Shield
Pin 5	Green	HT Can Hi
Pin 6	Orange	Can1 Hi
Pin 7	Blue	Can1 Low



### 006-6650VA to DCP Whip

Pin 1	Red	Can Power
Pin 2	Black	Can Ground
Pin 3	Yellow	HT Can Hi
Pin 4	Gray	Shield
Pin 5	Green	HT Can Low
Pin 6	Orange	Can1 Hi
Pin 7	Blue	Can1 Low



## Pin Outs (continued)

### 006-6650VA to 006-6650LS2

Pin 1	Red	Can Power
Pin 2	Black	Can Ground
Pin 3	Yellow	HT Can Hi
Pin 4	Gray	Shield
Pin 5	Green	HT Can Low
Pin 6	N/A	
Pin 7	N/A	



### 006-6650VA Harness to Baler Plug

Pin A	N/A	
Pin B	Red	TBC Power
Pin C	N/A	
Pin D	Gray	TBC Ground
Pin E	Orange	Can1 Hi
Pin F	Blue	Can1 Low

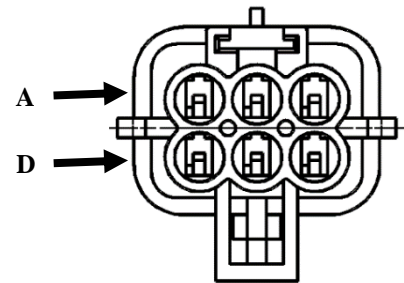

### Main Power Connector on Dual Channel Processor (DCP)

Pin 1	Red	+12V Power from tractor
Pin 2	Black	Ground from tractor
Pin 3	Orange	Keyed power

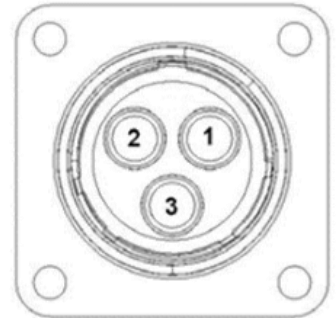

### Star Wheel and Bale Rate Sensor connector on DCP

Pin 1	Blue	+12V Power
Pin 2	Orange	Ground
Pin 3	Black	Signal for sensor 1
Pin 4	White	Signal for sensor 2
Pin 5	N/A	
Pin 6	N/A	
Pin 7	N/A	
Pin 8	Violet	Star wheel input 1
Pin 9	Brown	Star wheel input 2



### End of Bale sensor on DCP

Pin 1	Brown	Sensor Power
Pin 2	Blue	Sensor Ground
Pin 3	N/A	
Pin 4	Black	Signal from Sensor

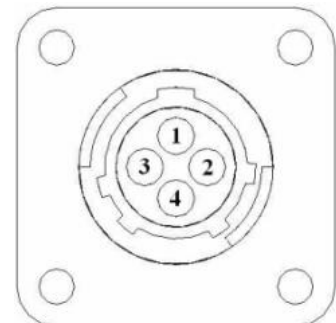

## Pin Outs (continued)

### Pump Communication Plug on DCP

Pin 1	Red	+12V Can
Pin 2	Red	+12V Power
Pin 3	Gray	Shield
Pin 4	Green	Comm Channel OH
Pin 5	Yellow	Comm Channel OL
Pin 6	Blue	Comm Channel IH
Pin 7	Orange	Comm Channel IL
Pin 8	Black	Can Ground
Pin 9	Black	Power Ground
Pin 10	N/A	

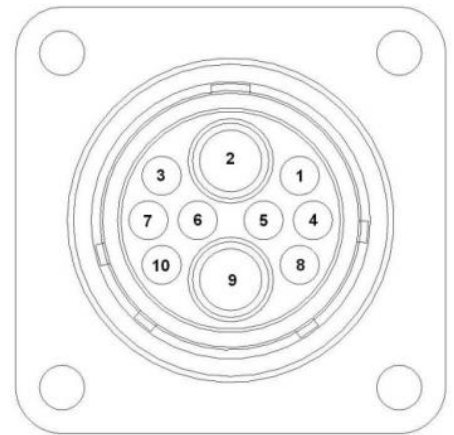

### Pump Connection Colors

Pin 1	Black with Orange Stripe	Pump 1 Ground
Pin 2	Black with Green Stripe	Pump 2 Ground
Pin 3	Black with Yellow Stripe	Shield
Pin 4	N/A	
Pin 5	Orange with Black Stripe	Pump 1 Positive
Pin 6	Green with Black Stripe	Pump 2 Positive
Pin 7	Yellow with Black Stripe	Pump 3 Positive

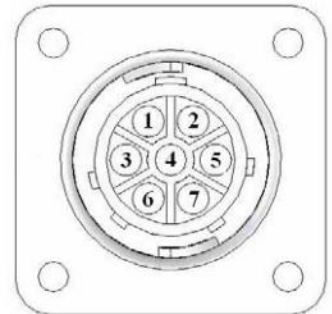

### Flow Meter Connection on Pump Controller

Pin 1	White	+5-12V Power
Pin 2	Green	Ground
Pin 3	Brown	Signal
Pin 4	Black	Shield

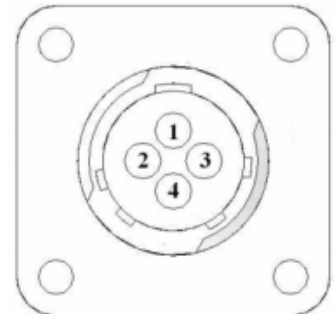

### Connector for Crop Eyes on DCP

Pin 1	Red	+12V Power
Pin 2	Black	Ground
Pin 3	White	Signal
Pin 4	N/A	

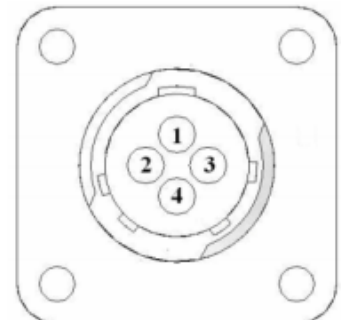

# Parts Breakdown Tank, Saddle and Legs 110 Gallon



**Not Pictured: Elbow**  
Part#:003-EL3412

- Tank Lid**  
Part#: 005-9022E  
or 005-9208L
- Tank-110 gallon**  
Part#: 005-9208
- Hand Rail**  
Part# 001-6707HR
- Tank Straps**  
Part#: 001-4402B
- Tank Saddle**  
Part#: 001-6707A
- Tank Fittings**  
Part#: 005-9100

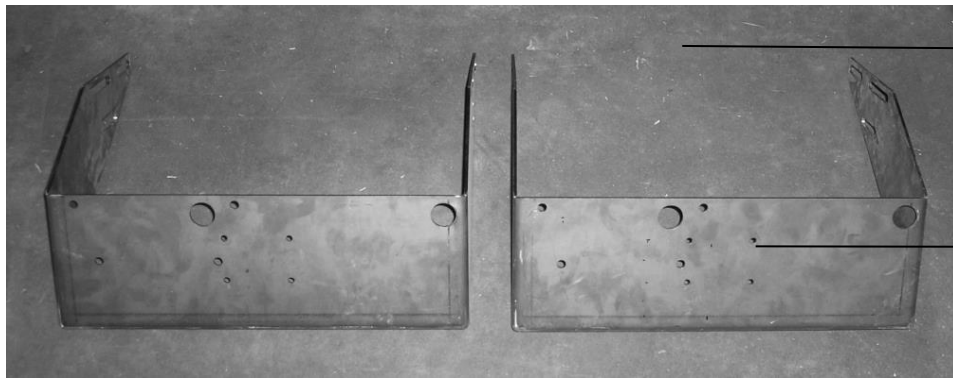

- Legs for: Agco,  
Hesston,  
Massey & Challenger**
- Saddle Legs**  
Part#: 001-6707C



## Parts Breakdown for Pump Manifold

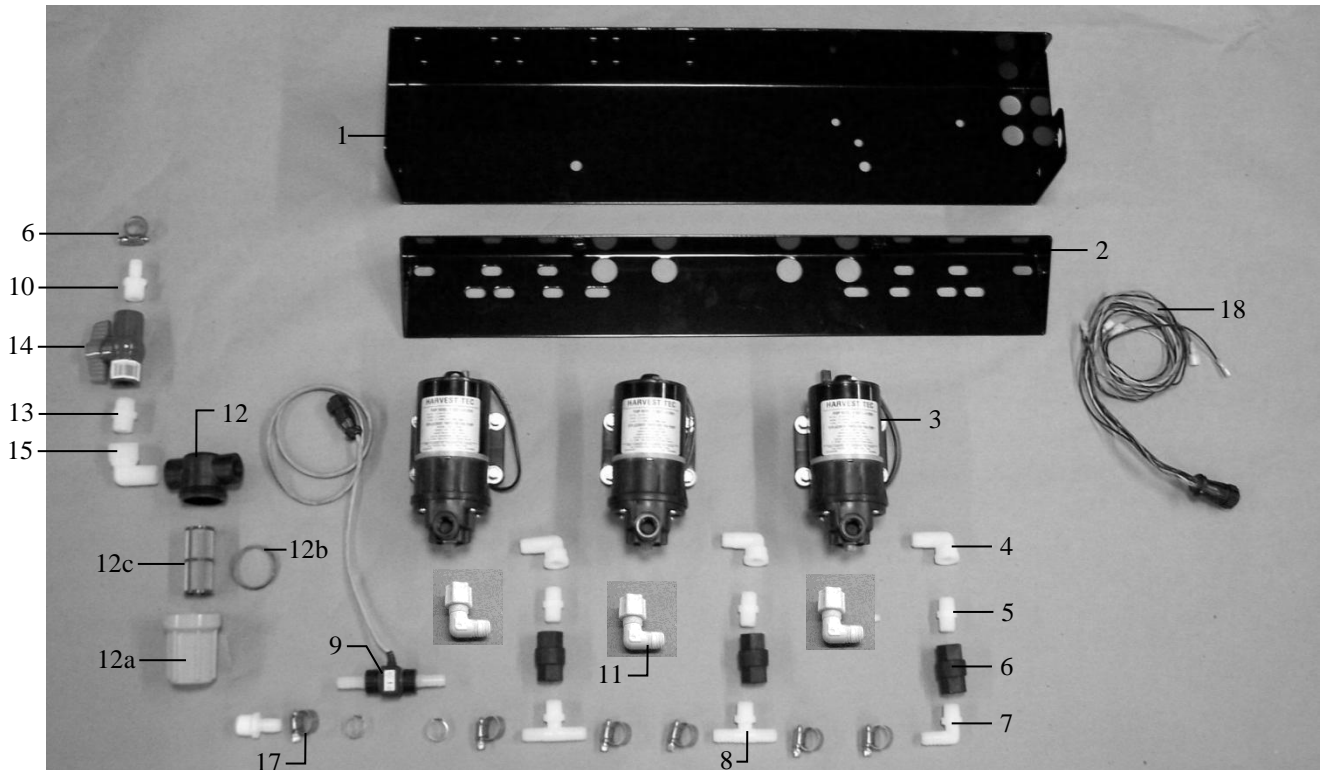

<u>Ref#</u>	<u>Description</u>	<u>Part#</u>	<u>Qty</u>
1	Pump plate	001-4646D	1
2	Mounting Bracket	001-4646C	1
3	Pump	007-4120H	3
4	Street elbow fitting	003-SE38	3
5	Nipple fitting	003-M3838	3
6	Check valve	002-4566F	3
7	Elbow fitting	003-EL3812	1
8	Tee fitting	003-T3812HB	2
9	Flow meter assembly	006-4725A	1
10	Straight fitting	003-A1212	2
11	Jaco fitting	003-JEL1238	3
12	Filter bowl assembly	002-4315-100	1
12a	Filter bowl only	002-4315F	1
12b	Filter bowl gasket	002-4315D	1
12c	Filter bowl screen	002-4315A	1
13	Nipple fitting	003-M1212	1
14	Ball valve	002-2212	1
15	Street elbow fitting	003-SE12	1
16	Hose clamp	003-9003	7
17	Hose clamp (Flow Meter)	003-9005	2
18	Pump Cable	006-4660Z	1
NP	Elbow	003-EL1212	1
NP	Pump rebuild kit (1 per pump)	007-4581	1
	Complete Pump Assembly	030-4646	

## Parts Breakdown for Star Wheel Moisture Sensors

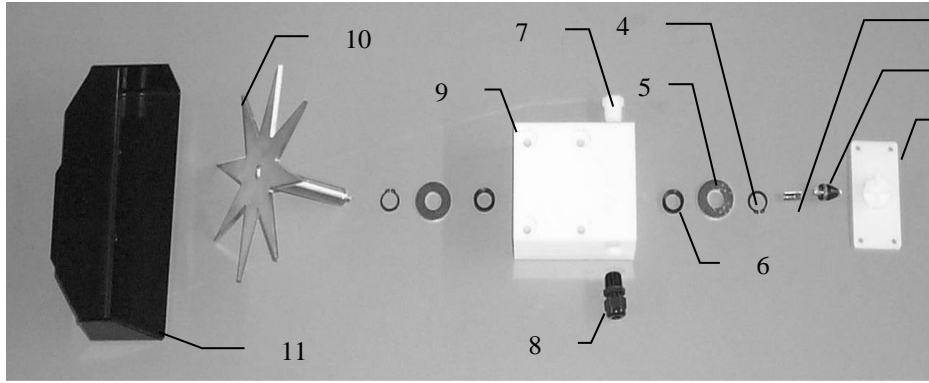

<u>Ref</u>	<u>Description</u>	<u>Part#</u>	<u>Qty</u>	<u>Ref</u>	<u>Description</u>	<u>Part#</u>	<u>Qty</u>
1	Block cover	006-4641B	2	9	Star wheel block	006-4641A	2
2	Electronic swivel	006-4642A	2	10	Star wheel sensor	030-4641C	2
3	Swivel insert	w/ Ref # 10	2	11	Twine guard-left for AGCO	001-4645H	1
4	Snap ring (per side)	006-4641K	2		Twine guard-right for AGCO	001-4644H	1
5	Washer (per side)	w/006-4641K	2		And with bale rate sensor		
6	Dust seal (per side)	w/006-4641K	2		holes in it.		
7	Plug fitting	003-F38	2	1-10	Star wheel assembly	030-4641	2
8	Wiring grommet	008-0821A	2	NP	Star wheel spacer	001-6707E	2

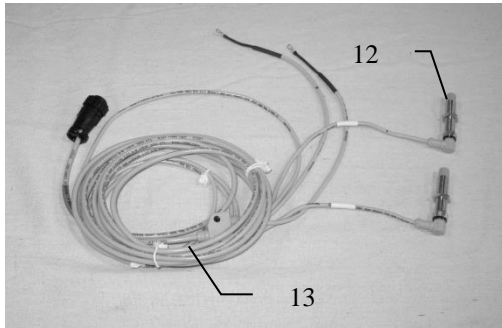

<u>Description</u>	<u>Part#</u>	<u>Qty</u>
12 Bale rate sensor	006-7303S	2
13 Moisture and bale rate harness	006-7303H	1

## Star Wheel Moisture Sensors UHD Balers (4544B Install Kit)

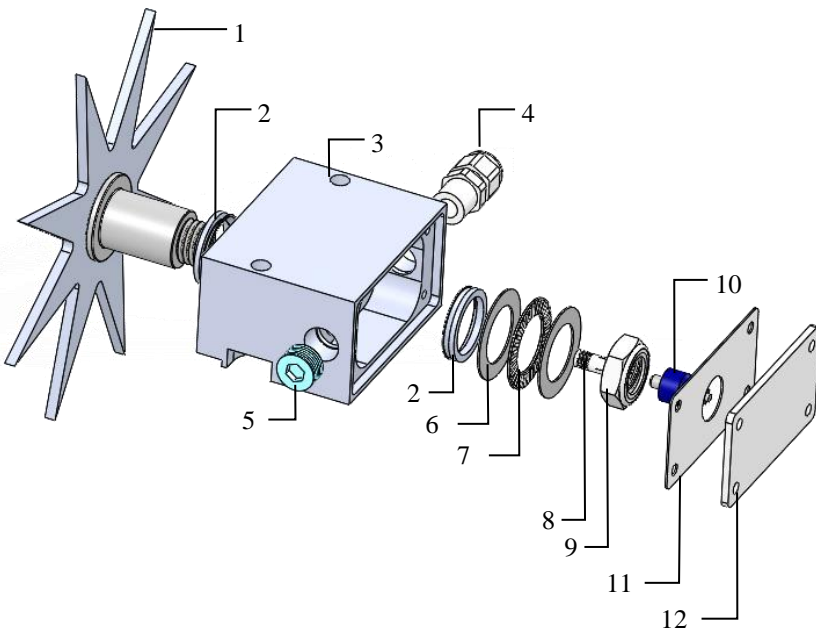

<u>Ref</u>	<u>Description</u>	<u>Part#</u>	<u>Qty</u>
1	Univ Star Wheel	006-4641S	1
2	Dust Seal	006-4641DSL	2
3	Univ Star Block	006-4641Q	1
4	3/8" NPT Cable Grip	008-0821A	1
5	3/8" NPT Plug	003-F38	1
6	Thrust Washer	006-4641TA	2
7	Thrust Bearing	006-4641TB	1
8	Swivel Insert	006-4642B	1
9	3/4" Short Nut	006-4641U	1
10	Rotary Swivel	006-4642A	1
11	Cover Gasket	006-4641RG	1
12	Univ Block Cover	006-4641R	1
	Complete Assembly	030-4641U	2

## Parts Breakdown for 696M Control Boxes and Harnesses

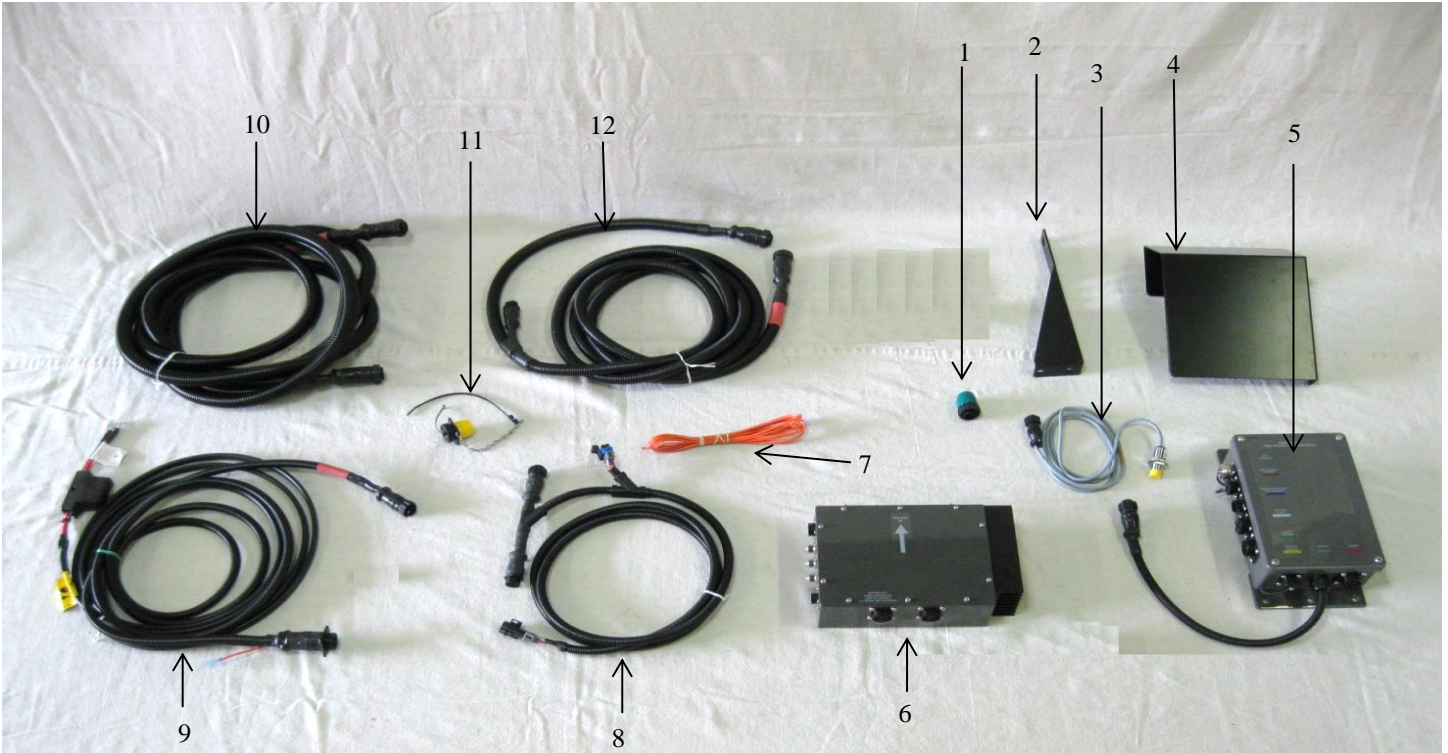

Ref	Description	Part Number	Qty
1	Terminating Resistor Series	006-5650Z	1
2	End of Bale Sensor Bracket	001-4648	1
3	End of Bale Sensor Series	006-7400	1
4	DCP Shield/Cover	001-5650X	1
5	DCP Main Control LS 600 AUTO	006-6671LS	1
6	Pump Controller	006-5672	1
7	Key Switch Wire	006-5650K	1
8	DCP Baler Interface Harness	006-6650VA	1
9	DCP Tractor Harness	006-6650TM(E)	1
10	Modular Power/Comm 10 FT Harness	006-5650FM(E)	1
11	Dust Plugs	006-5651PLUGS	1
12	DCP Baler Harness 30 FT	006-6650LS2(E)	1
NP	UHD Integration Harness (4544B Only)	006-6650VAU	1
NP	USB Cable	006-6672USBC	1

AGCO 2100 Series Baler-Pre 2012 will need 006-6650VAX

### iPad Integration Control



Part #: 030-6672C

\*Note: (E) indication is used for International Dealers

## Parts Breakdown for Hose and Drain / Fill Line

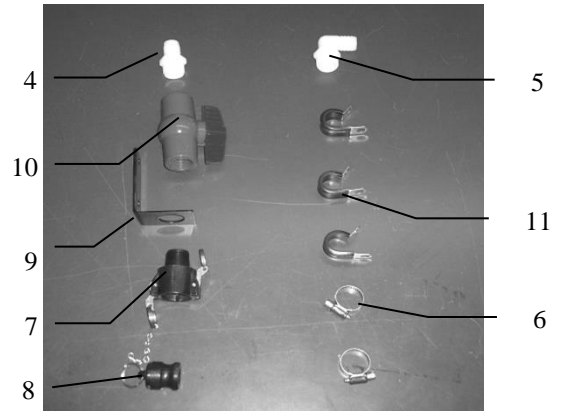
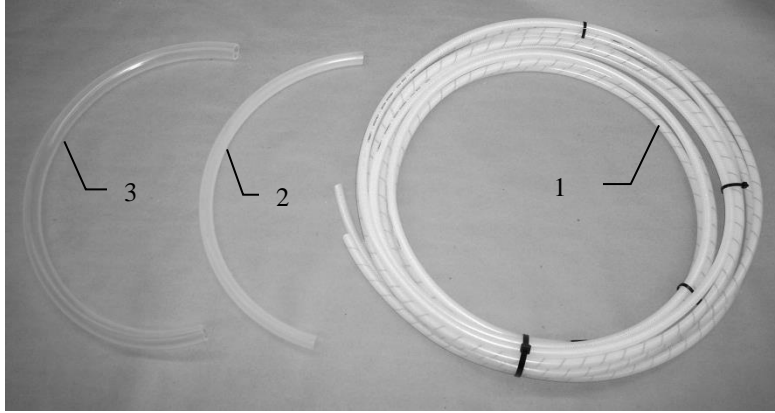

<u>Ref</u>	<u>Description</u>	<u>Part#</u>	<u>Qty</u>
1	Triple weld hose (from pumps to tips)	002-9016	35ft
		002-9016B	35ft
		002-9016G	35ft
	Three hose assembly	030-9016LS	1
2	1/2" Hose (tank to filter)	002-9001	6ft
3	3/4" Hose (tank to drain/fill valve)	002-9002	5ft
4	Straight Fitting	003-A3434	1
5	Elbow	003-EL3434	1
6	Hose Clamps	003-9004	2

<u>Ref</u>	<u>Description</u>	<u>Part#</u>	<u>Qty</u>
7	Female Coupler	002-2204A	1
8	Male Coupler	002-2205G	1
9	Valve Holder	001-6702H	1
10	Ball valve	002-2200	1
11	Jiffy Clip	008-9010	3

## Optional iPad Mini Mounting Kit (030-2014MK)

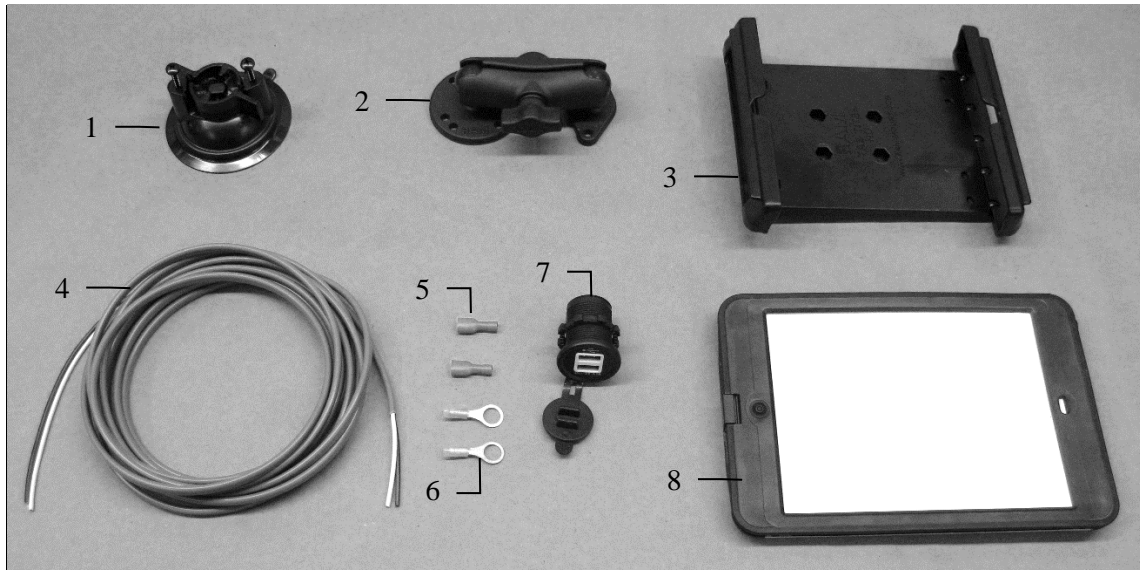

<u>Ref</u>	<u>Description</u>	<u>Part #</u>	<u>Qty</u>
1	Suction cup mount	001-2012SCM	1
2	Ram mount	001-2012H	1
3	iPad Mini® spring load cradle (Mini 4)	001-2012SLC	1
4	16 gauge power wire	006-4723P	1
5	Female spade connector	Hardware	2
6	Eye loop connector	Hardware	2
7	iPad Mini Charger 12V	001-2012P	1
8	iPad Mini 4 case	001-2012C4	1
NP	4 amp fuse	Hardware	1
Mounting Kit Assembly		030-2014MK (Includes All Parts)	

### Installation Instructions

1. Identify 12V power source for wires to connect.
  - a. Eye loops included if wiring directly to the battery is desired.
  - b. Test for key power source if preferred to have power to the USB shut off with the key.
2. Once power source is identified, cut wires to desired length.
3. Crimp the two supplied quick connectors onto each the white and black wire.
4. Remove the round locking plastic nut from USB plug before connecting the wires. Black (+) White (-).
5. The wires will then be hooked to the designated terminals on the bottom of the USB plug
6. Drill a 1 1/8" hole in the preferred mounting location. Be sure to clean any sharp edges after drilling.
7. Feed the wires through the mounting hole.
8. If using the round plastic nut to secure plug in place, slide the nut back over the wiring before connecting the wires to powered source.
9. Connect the wires to the identified power source if easier to do so before tightening the plug into place.
10. Tighten plug using either the round plastic nut or mounting plate and two screws, both options supplied.
11. Once connected, hook a USB charging cord into the plug and connect a mobile device/tablet to ensure the plug is operating as you wish (key power working properly if necessary).

NOTE: This plug is not designed to charge two iPads. System damage could occur if this is attempted. System will charge a mobile phone and iPad simultaneously without problem.

\*iPad mini is a trademark of Apple Inc., registered in the U.S. and other countries.



## Optional iPad Display Kit (030-4670DK)

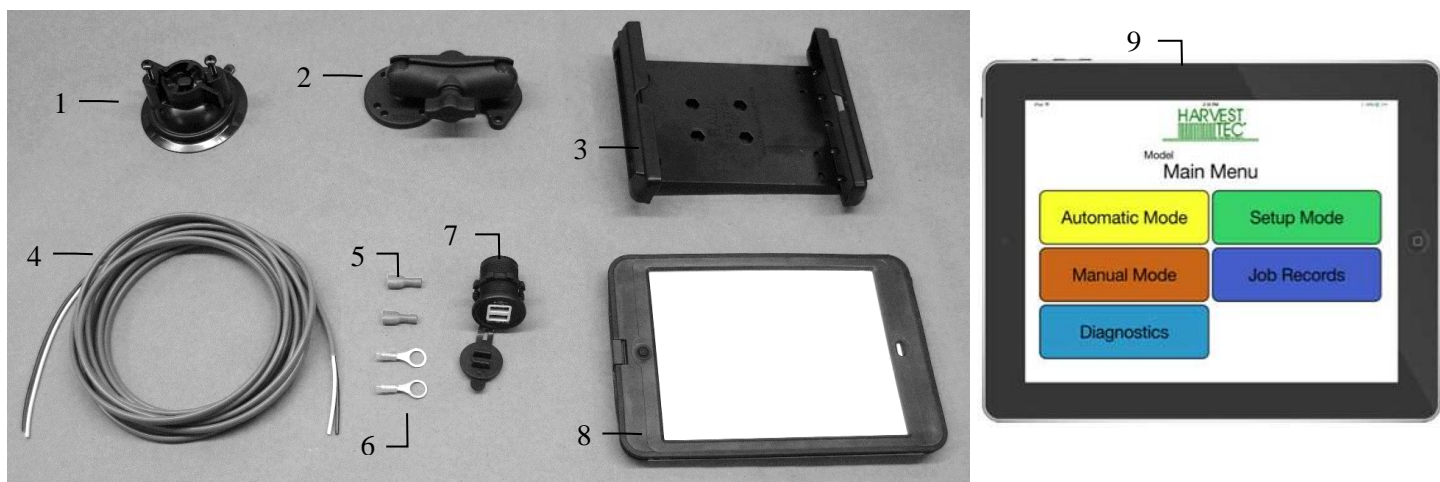

Ref	Description	Part #	Qty	Ref	Description	Part #	Qty
1	Suction cup mount	001-2012SCM	1	7	iPad Mini Charger 12V	001-2012P	1
2	Ram mount	001-2012H	1	8	iPad Mini 4 case	001-2012C4	1
3	iPad Mini® spring load cradle (Mini 4)	001-2012SLC	1	9	iPad Mini 4	006-4670IP	1
4	16 gauge power wire	006-4723P	1	NP	4 amp fuse	Hardware	1
5	Female spade connector	Hardware	2				
6	Eye loop connector	Hardware	2				
					Mounting Kit Assembly	030-4670DK (Includes All Parts)	

### Installation Instructions

1. Identify 12V power source for wires to connect.
  - a. Eye loops included if wiring directly to the battery is desired.
  - b. Test for key power source if preferred to have power to the USB shut off with the key.
2. Once power source is identified, cut wires to desired length.
3. Crimp the two supplied quick connectors onto the white and black wire.
4. Remove the round locking plastic nut from USB plug before connecting the wires. Black (+) White (-).
5. The wires will then be hooked to the designated terminals on the bottom of the USB plug
6. Drill a 1 1/8" hole in the preferred mounting location. Be sure to clean any sharp edges after drilling.
7. Feed the wires through the mounting hole.
8. If using the round plastic nut to secure plug in place, slide the nut back over the wiring before connecting the wires to powered source.
9. Connect the wires to the identified power source if easier to do so before tightening the plug into place.
10. Tighten plug using either the round plastic nut or mounting plate and two screws, both options supplied.
11. Once connected, hook a USB charging cord into the plug and connect a mobile device/tablet to ensure the plug is operating as you wish (key power working properly if necessary).

**NOTE: This plug is not designed to charge two iPads. System damage could occur if this is attempted. System will charge a mobile phone and iPad simultaneously without problem.**

\*iPad mini is a trademark of Apple Inc., registered in the U.S. and other countries.

## Installation Kits Specific to Balers 4518B Installation Kit

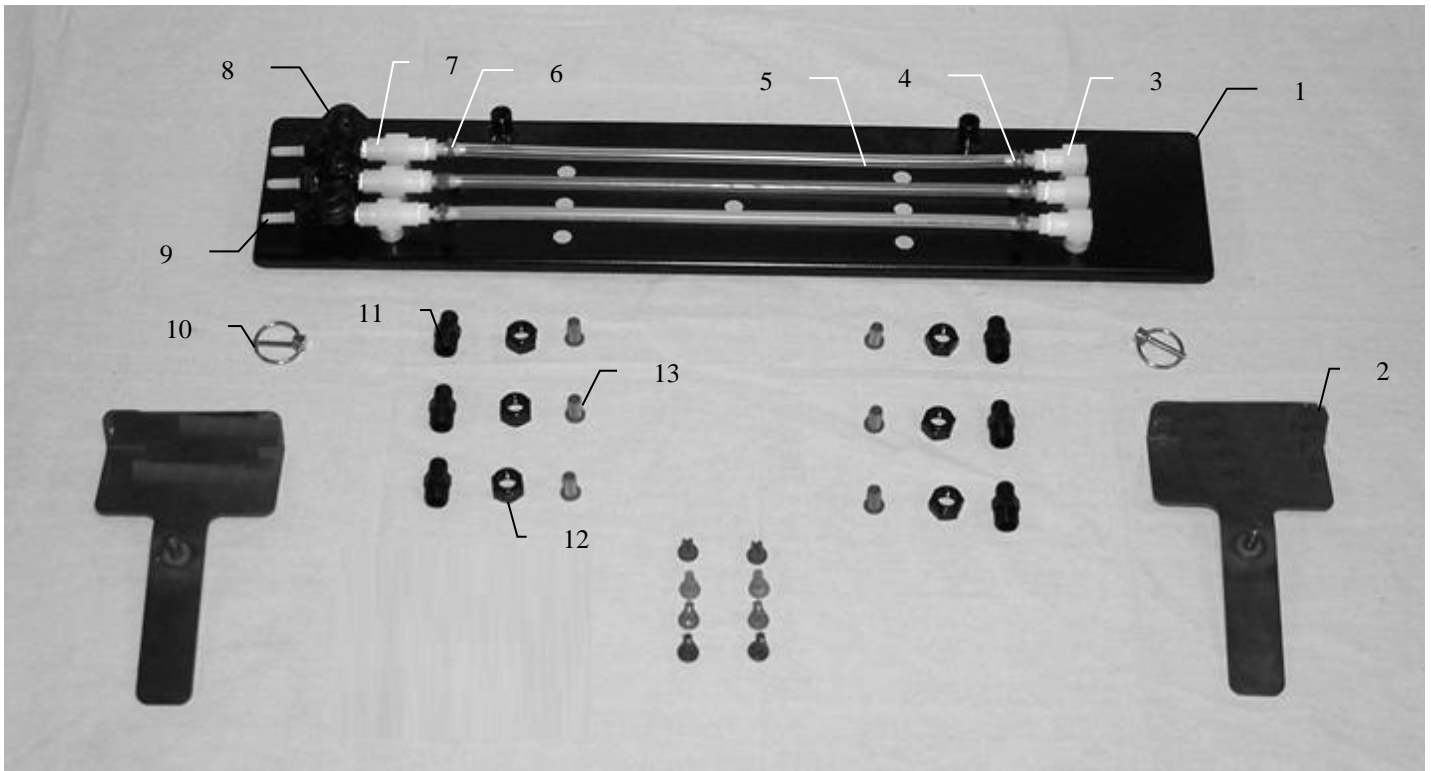

<u>Ref</u>	<u>Description</u>	<u>Part #</u>	<u>Qty</u>	<u>Description</u>	<u>Part #</u>	<u>Qty</u>
1	Spray shield	001-4435ES	1	Tip-Olive Green	004-800067-PT	2
2	Shield holder	001-4435H	2	Tip-Orange	004-TT11001VP	2
3	Elbow	003-SE14F	3	Tip-Green	004-TT110015VP	2
4	Straight fitting	003-A1414	6	Tip-Blue	004-TT11003VP	2
5	Hose	002-9016	6			
6	Hose clamp	003-9002	9			
7	Tee	003-TT14SQ	3			
8	Check valve	004-1207VB	3			
9	Straight fitting	003-A1414VB	3			
10	Lynch pin	008-4576	2			
11	Nozzle body	004-4722	6			
12	Nozzle cap	004-4723	9			
13	Tip strainer	004-1203-100	6			

## 4519B Installation Kit

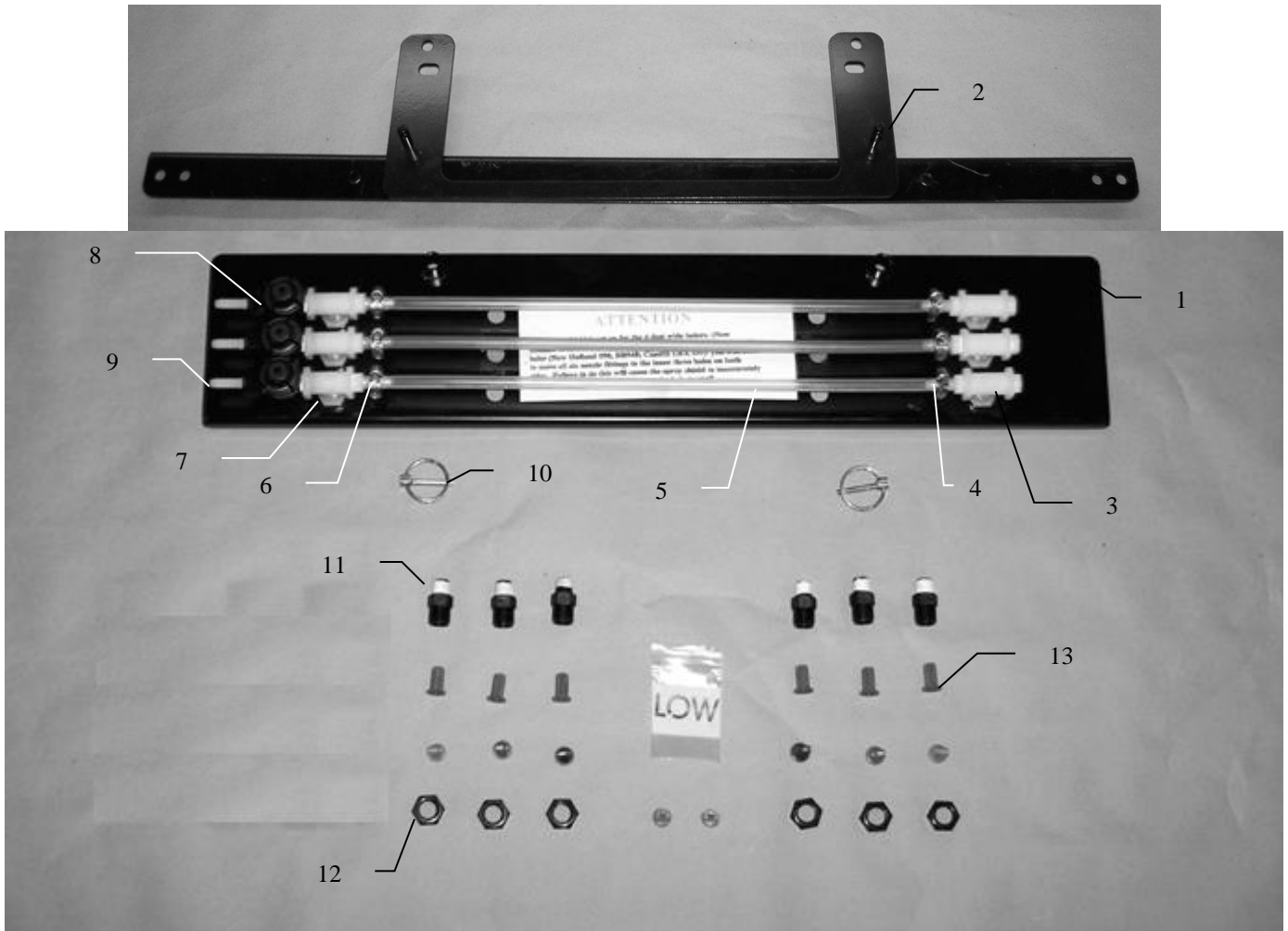

<u>Ref</u>	<u>Description</u>	<u>Part #</u>	<u>Qty</u>	<u>Description</u>	<u>Part #</u>	<u>Qty</u>
1	Spray shield	001-4435AS	1	Tip-Olive Green	004-800067-PT	2
2	Shield holder	001-4435J	1	Tip-Orange	004-TT11001VP	2
3	Elbow	003-SE14F	3	Tip-Green	004-TT110015VP	2
4	Straight fitting	003-A1414	6	Tip-Blue	004-TT11003VP	2
5	Hose	002-9016	6			
6	Hose clamp	003-9002	9			
7	Tee	003-TT14SQ	3			
8	Check valve	004-1207VB	3			
9	Straight fitting	003-A1414VB	3			
10	Lynch pin	008-4576	2			
11	Nozzle body	004-4722	6			
12	Nozzle cap	004-4723	9			
13	Tip strainer	004-1203-100	6			

## 4527B Installation Kit

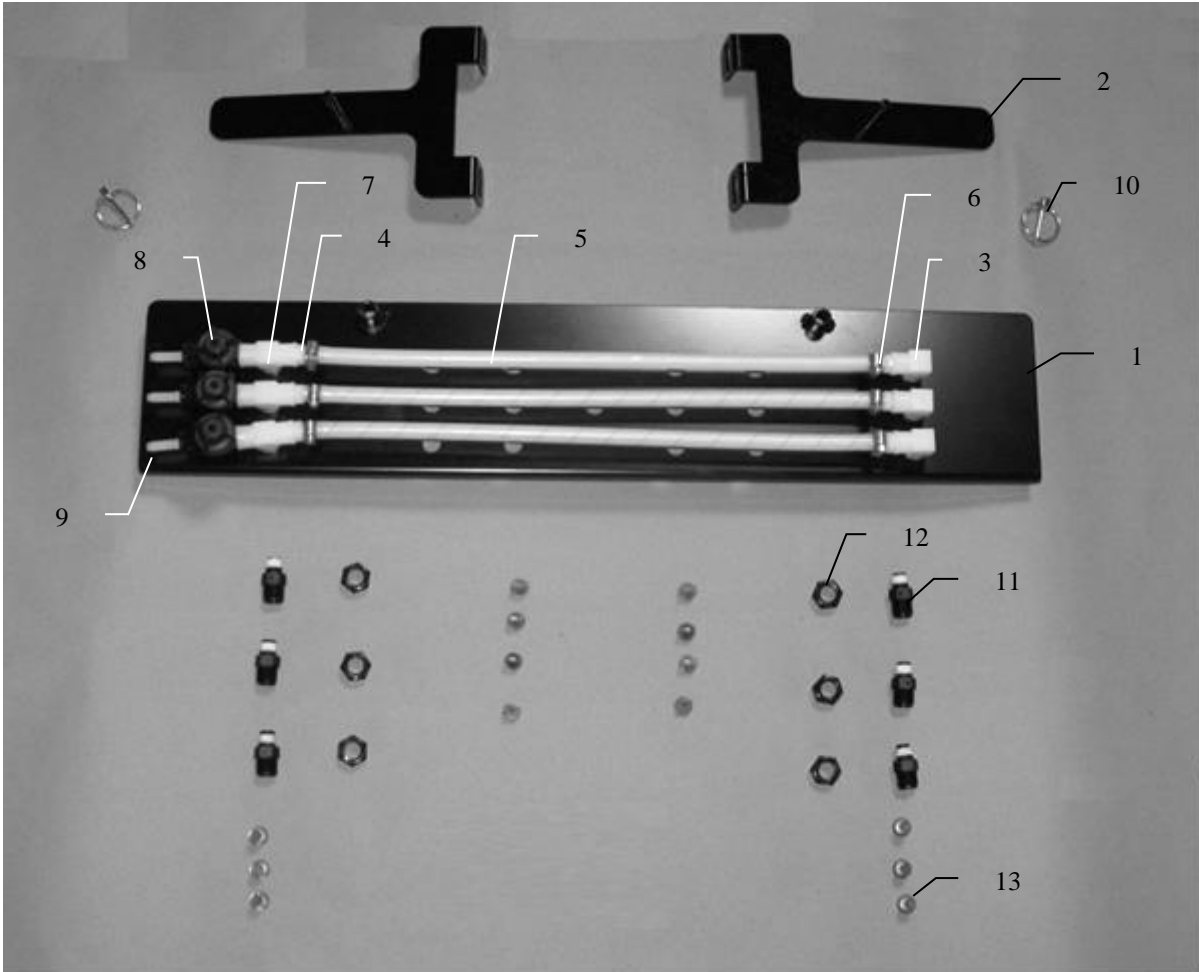

<u>Ref</u>	<u>Description</u>	<u>Part #</u>	<u>Qty</u>	<u>Description</u>	<u>Part #</u>	<u>Qty</u>
1	Spray shield	001-4435ES	1	Tip-Olive Green	004-800067-PT	2
2	Shield holder	001-4435HPC	2	Tip-Orange	004-TT11001VP	2
3	Elbow	003-SE14F	3	Tip-Green	004-TT110015VP	2
4	Straight fitting	003-A1414	6	Tip-Blue	004-TT11003VP	2
5	Hose	002-9016	6			
6	Hose clamp	003-9002	9			
7	Tee	003-TT14SQ	3			
8	Check valve	004-1207VB	3			
9	Straight fitting	003-A1414VB	3			
10	Lynch pin	008-4576	2			
11	Nozzle body	004-4722	6			
12	Nozzle cap	004-4723	9			
13	Tip strainer	004-1203-100	6			

## 4530B Installation Kit

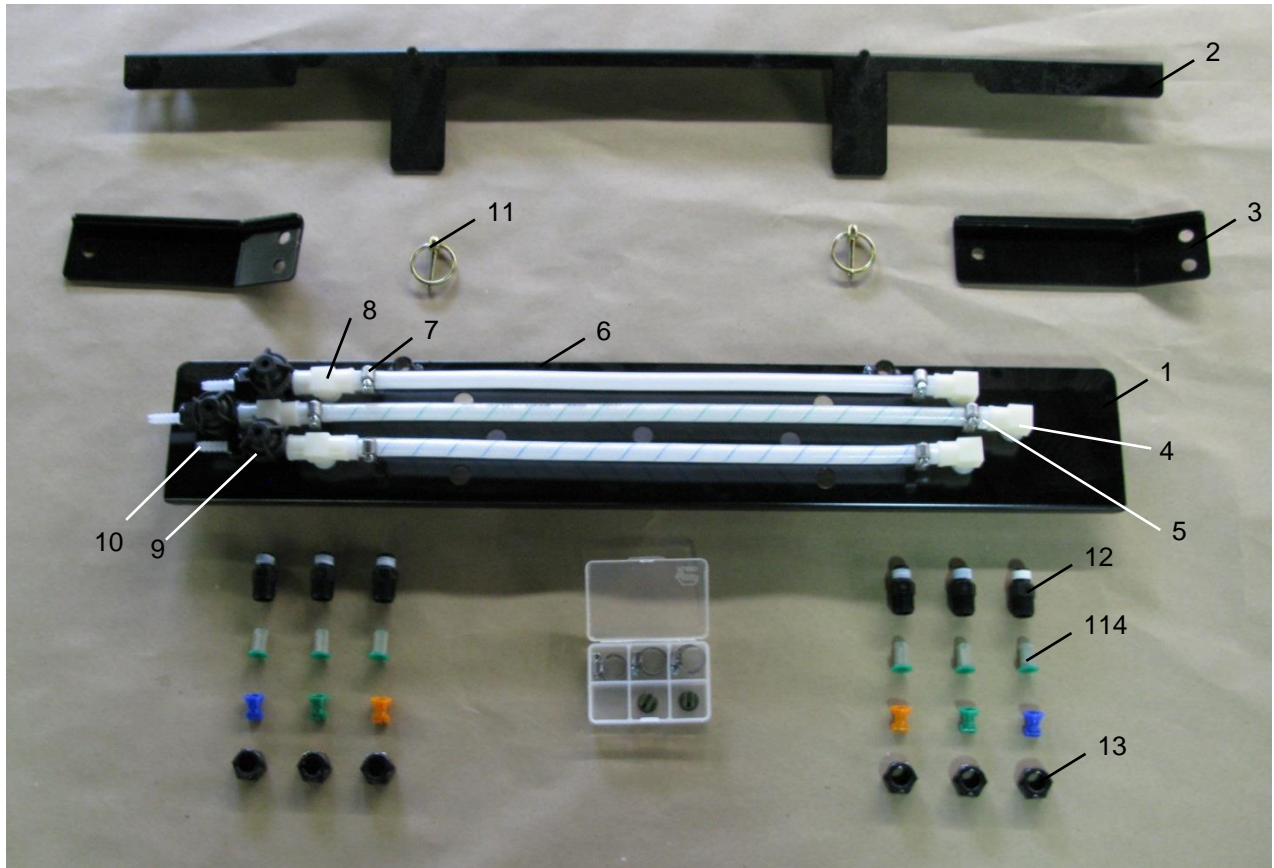

<u>Ref</u>	<u>Description</u>	<u>Part #</u>	<u>Qty</u>	<u>Description</u>	<u>Part #</u>	<u>Qty</u>
1	Spray shield	001-4435AS	1	Tip-Olive Green	004-800067-PT	2
2	Shield holder	001-4435XA	1	Tip-Orange	004-TT11001VP	2
3	Holder bracket	001-4435XB	2	Tip-Green	004-TT110015VP	2
4	Elbow	003-SE14SQ	3	Tip-Blue	004-TT11003VP	2
5	Straight fitting	003-A1414	6			
6	Hose	002-9016	6			
7	Hose clamp	003-9002	9			
8	Tee	003-TT14SQ	3			
9	Check valve	004-1207VB	3			
10	Straight fitting	003-A1414VB	3			
11	Lynch pin	008-4576	2			
12	Nozzle body	004-4722	6			
13	Nozzle cap	004-4723	9			
14	Tip strainer	004-1203-100	6			
NP	Star wheel spacer	001-6707E	2			
NP	Not pictured					



## 4542B Installation Kit

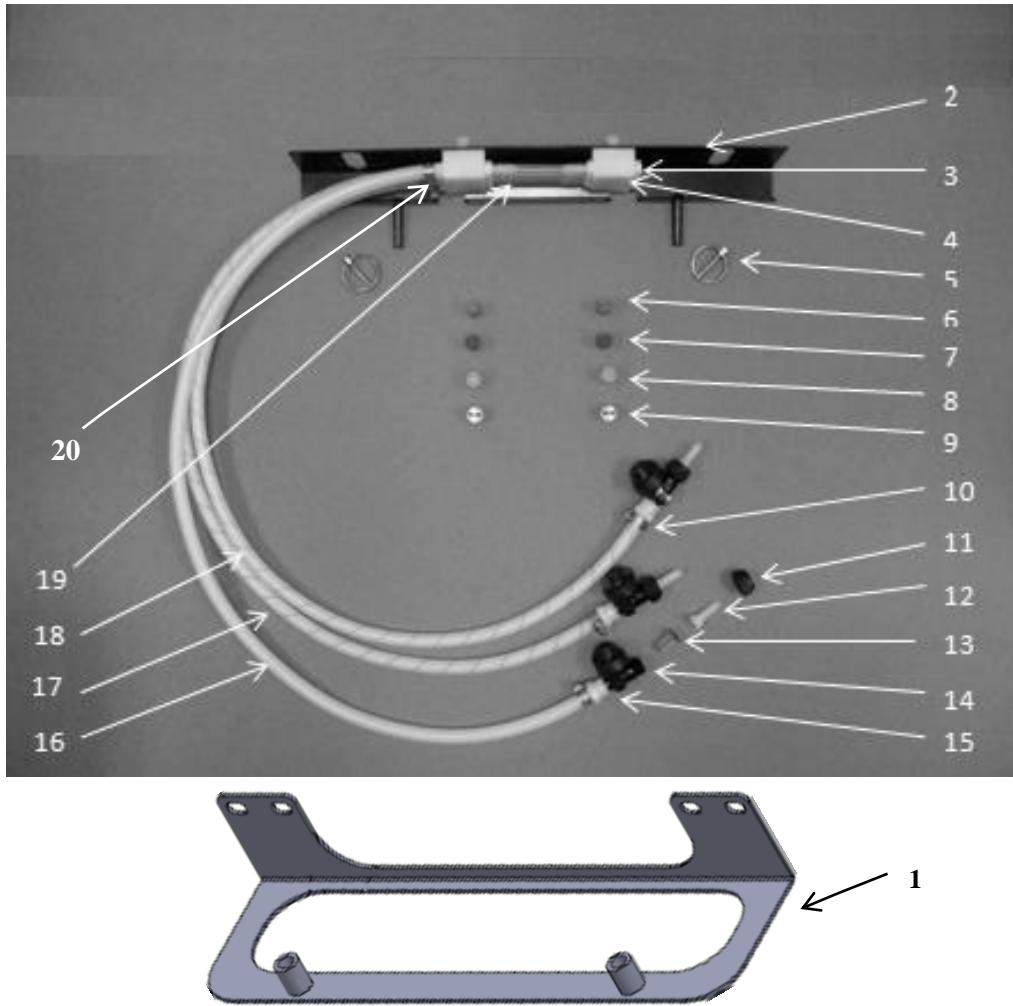

<u>Ref</u>	<u>Description</u>	<u>Part Number</u>	<u>Qty</u>	<u>Ref</u>	<u>Description</u>	<u>Part Number</u>	<u>Qty</u>
1	Holder	001-4435NAX	1	11	Cap	004-4723	3
2	Shield	001-4435NSX	1	12	Fitting	003-A1414VB	3
3	Fitting	003-F14	3	13	Strainer	004-1203-100	3
4	Manifold Block	001-4435NSB	2	14	Check Valve	004-1207VB	3
5	Lynch Pin	008-4576	2	15	Fitting	003-A1414F	3
6	Tip-Red	004-T8003-PT	2	16	Clear Tubing-1/4"	002-9016	3ft
7	Tip-Brown	004-T80015-PT	2	17	Blue Stripe Tubing	002-9016B	3ft
8	Tip-Pink	004-T8001-PT	2	18	Green Stripe Tubing	002-9016G	3ft
9	Tip-Stainless	004-T800067-SS	2	19	EVA-1/4"	002-9006	2ft
10	Hose Clamp	003-9002	15	20	Fitting	003-A1414	9
				NP	Mini Plano Box	008-9001	1
				NP	EOB Bracket	001-4648K	1

## 4544B Installation Kit

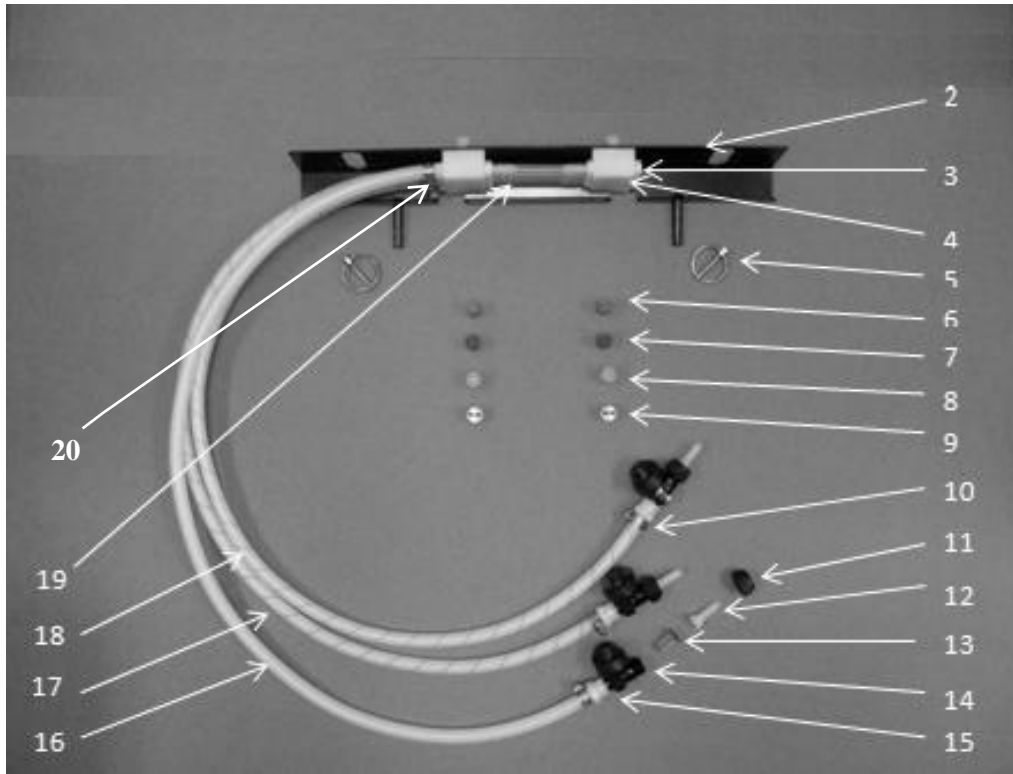

<u>Ref</u>	<u>Description</u>	<u>Part Number</u>	<u>Qty</u>	<u>Ref</u>	<u>Description</u>	<u>Part Number</u>	<u>Qty</u>
1	Holder	001-4435U	1	11	Cap	004-4723	3
2	Shield	001-4435NSX	1	12	Fitting	003-A1414VB	3
3	Fitting	003-F14	3	13	Strainer	004-1203-100	3
4	Manifold Block	001-4435NSB	2	14	Check Valve	004-1207VB	3
5	Lynch Pin	008-4576	2	15	Fitting	003-A1414F	3
6	Tip-Red	004-T8003-PT	2	16	Clear Tubing-1/4"	002-9016	3ft
7	Tip-Brown	004-T80015-PT	2	17	Blue Stripe Tubing	002-9016B	3ft
8	Tip-Pink	004-T8001-PT	2	18	Green Stripe Tubing	002-9016G	3ft
9	Tip-Stainless	004-T800067-SS	2	19	EVA-1/4"	002-9006	1ft
10	Hose Clamp	003-9002	15	20	Fitting	003-A1414	9
				NP	Mini Plano Box	008-9001	1

## **Harvest Tec LLC. Warranty and Liability Agreement**

Harvest Tec, LLC. will repair or replace components that are found to be defective within 12 months from the date of manufacture. Under no circumstances does this warranty cover any components which in the opinion of Harvest Tec, LLC. have been subjected to negligent use, misuse, alteration, accident, or if repairs have been made with parts other than those manufactured and obtainable from Harvest Tec, LLC.

Our obligation under this warranty is limited to repairing or replacing free of charge to the original purchaser any part that in our judgment shows evidence of defective or improper workmanship, provided the part is returned to Harvest Tec, LLC. within 30 days of the failure. If it is determined that a non-Harvest Tec branded hay preservative has been used inside the Harvest Tec applicator system where the failure occurred, then Harvest Tec reserves the right to deny the warranty request at their discretion. Parts must be returned through the selling dealer and distributor, transportation charges prepaid.

This warranty shall not be interpreted to render Harvest Tec, LLC. liable for injury or damages of any kind, direct, consequential, or contingent, to persons or property. Furthermore, this warranty does not extend to loss of crop, losses caused by delays or any expense prospective profits or for any other reason. Harvest Tec, LLC. shall not be liable for any recovery greater in amount than the cost or repair of defects in workmanship.

There are no warranties, either expressed or implied, of merchantability or fitness for particular purpose intended or fitness for any other reason.

This warranty cannot guarantee that existing conditions beyond the control of Harvest Tec, LLC. will not affect our ability to obtain materials or manufacture necessary replacement parts.

Harvest Tec, LLC. reserves the right to make design changes, improve design, or change specifications, at any time without any contingent obligation to purchasers of machines and parts previously sold.

Revised 5/22

**HARVEST TEC, LLC.**  
**P.O. BOX 63**  
**2821 HARVEY STREET**  
**HUDSON, WI 54016**  
PHONE: 715-386-9100  
1-800-635-7468  
FAX: 715-381-1792  
Email: [info@harvesttec.com](mailto:info@harvesttec.com)