

Operation Manual

***Model 431,434,440,441,442,445Z,448
25 & 55 Gallon Preservative Applicator***

HARVEST
**TEC** *Equipment and Products
for Quality Hay.™*

P.O. Box 63 • 2821 Harvey Street • Hudson, WI 54016
800-635-7468 • www.harvesttec.com

DECLARATION OF INCORPORATION



MANUFACTURER:

Harvest Tec LLC.
2821 Harvey St.
P.O. Box 63
Hudson, WI 54016, U.S.A.

REPRESENTATIVE ESTABLISHED IN COMMUNITY: Profitable Farming Company
Middle Barlington, Roborough
Winkleigh, Devon, EX19 8AG
ENGLAND

The person above certifies and declares that:

VIRTUAL MACHINE: Equipment mounted on a farm press and for the application of inoculants onto forage crops.

MODEL: 431-434-440-441-442-448-18-OPR Imp&Metric

BRAND: Harvest Tec

SERIAL NUMBER:

This application preservatives for hay Harvest Tec system meets the Directive 2006/42/EC of the European Parliament and the Council of 17 May 2006 and other applicable European Directives including Directive 2004/108/EC on the Electromagnetic compatibility.

The application of preservatives for hay Harvest Tec system will be turned on after being installed on a farm press has been declared in conformity with the Machinery Directive.

Person in the community authorized to provide information on the partly completed machinery and making this statement:

Richard Snell, President, Profitable Farming Company
Signed on May 21, 2011: Middle Barlington, Roborough
Winkleigh, Devon, EX19 8AG

Harvest Tec Electronic Kit Table of Contents

	<u>Page</u>
Model Reference	5
Introduction & Safety	6
Safety Sign Descriptions	7
Preparing the Applicator for Operation	8-9
Filling the tank	8-9
Model 434, 440, 442 & 448	8
Model 441	9
Operation of the main ball valve	9
Connecting the power harness	9
Operation of the 457 Control Box	10
Understanding and using the 457 Control Box	10
Message light	10
First Time and Annual Start Up	10-19
Field Operation	11
Calibration	11
Determining tons per hour for small square balers (two tie)	11
Determining tons per hour for small square balers (three tie)	12
Determining tons per hour for round balers	13
Determining the rate of chemical	14
Selecting tips and setting pressure for small square balers	14
Calibration reminders	14
Selecting tips and setting pressure for round balers	15
Calibration reminders	15
Calibration chart for one nozzle	16
Calibration chart for two nozzles	17
Calibration chart for John Deere 8 & 9 Series, 445Z for two nozzles	18
Calibration chart for three nozzles	19
Maintenance	20-22
Maintenance schedule	20
Filter bowl cleaning	20
Tip & tip screen cleaning	21
Tank lid cleaning	21
Dielectric grease connections	21
Rebuilding pump	21
Battery connection	21
Miscellaneous maintenance	22
Winter Storage	22
Troubleshooting Checks	23
Parts Breakdown	24-63
Model 431 base kit	24
Model 434 base kit	25
Model 440 base kit	26
Model 441 base kit	27
Model 442 base kit	28
Model 445Z base kit	29-30
Model 448 base kit	31
Model 457 control box	32
Drain fill kit (models 434, 440, 442 & 448 only)	32
Model Specific Installation Kits	33-63
Install kit 442-SO	33
Install kit 4400C	34

Table of Contents (continued)

Install kit 4409	35
Install kit 4410	36
Install kit 4415	37
Install kit 4415-SO	38
Install kit 4416	39
Install kit 4481	40
Install kit 4482	41
Install kit 4483	42
Install kit 4484	43
Install kit 4485	44
Install kit 4486	45
Install kit 4502	46
Install kit 4503	47
Install kit 4504	48
Install kit 4505	49
Install kit 4506	50
Install kit 4507	51
Install kit 4508	52
Install kit 4512	53
Install kit 4513	54
Install kit 4516	55
Install kit 4517	56
Install Kit 445Z (4516-SO)	57
Install kit 4523	58
Install kit 4524	59
Install kit 4526	60
Install kit 4538	61
Install kit 4546	62
Install kit 4547	63
Notes	64-66
Warranty Statement	67

Model Reference

Baler Make	Baler Model	Model Number	Installation Kit	Tank Size
Case IH	SBX530 - SBX550 & SB531 – SB551 square balers	440	4415-SO	55 gallon
Case IH	Four foot RBX & RB round balers	442	442-SO	25 gallon
Case IH	Five foot RBX & RB round balers	442	442-SO	55 gallon
Case IH	SBX 520 square baler	441	4409	25 gallon
Case IH	SBX530 - SBX550 & SB531 – SB551 square balers	441	4415	25 gallon
Case IH	All inline balers	441	4485	55 gallon
Case IH	2002 and older round balers	441	4484	25 gallon
Challenger	RB34 – RB56	441	4484	25 gallon
Challenger	RB 46 & 56	448	4508	55 gallon
Challenger	453, 463 & 563	448	4524	55 gallon
Freeman	330, 370, 380 & 385	448	4506	55 gallon
John Deere	All square balers	441	4410	25 gallon
John Deere	582 & 854	448	4503	55 gallon
John Deere	5, 6 & 7 series	441	4483	25 gallon
John Deere	5, 6 & 7 series	448	4504	55 gallon
John Deere	8 & 9 series	441	4516	25 gallon
John Deere	8 & 9 series	448	4517	55 gallon
John Deere	410-510 & 430-530 round balers	441	4484	25 gallon
Krone	All Krone round balers	441	4484	25 gallon
Kubota	BV4160, BV4180, BV5160	441	4481	25 gallon
New Holland	4 foot BR round balers	442	442-SO	25 gallon
New Holland	5 foot BR round balers	442	442-SO	55 gallon
New Holland	570 - 580 & BC5060-BC5080 square balers	440	4415-SO	55 gallon
New Holland	200 & 300 series, 565 square balers	441	4409	25 gallon
New Holland	570 - 580 & BC5060-BC5080 square balers	441	4415	25 gallon
New Holland	640-688 round balers	441	4486	25 gallon
New Holland	630-638 round balers	441	4484	25 gallon
New Holland	BB 900 & 585	448	4507	55 gallon
Massey Ferguson	All inline two tie balers	434	4416	55 gallon
Massey Ferguson	All inline three tie balers	448	4502	55 gallon
Massey Ferguson	800-900 series round balers & 5446-5556 & 2646-2766	448	4508	55 gallon
Massey Ferguson	2846-2856A	448	4524	55 gallon
Massey Ferguson	4100 Series	431	4523	20 gallon
McHale	V660 & F540 - F560 round balers	448	4526	55 gallon
Vermeer	640 & 605 M & Super M	448	4505	55 gallon
Vermeer	Rebel series	441	4484	25 gallon
Vermeer	404, 504 & 604 Pro	431	4523	20 gallon
Vermeer	ZR5 Baler	445Z	4516-SO	55 gallon
Other	Small square balers	441	4409	25 gallon
Other	Round balers	441	4484	25 gallon

Introduction

Congratulations on and thank you for purchasing a Harvest Tec Model 440, 441, 442 & 448 Applicator. This applicator is designed to apply a buffered propionic acid on to the forage crop as it is being baled. The applicator is designed to allow the operator to adjust the rate of preservative on the go for changing moisture and baler throughput. This manual will take you through the steps of operation of the applicator and also point out all safety precautions that need to be made while using the applicator.

Read this manual carefully to learn how to operate the equipment correctly. Failure to do this can result in personal injury or equipment malfunction. If you are unsure about operating the system after consulting this manual, contact your local authorized dealership for additional assistance. If you are in need of parts for the system please see the parts breakdown in the back of this manual and contact your local authorized dealer to order the parts. This applicator is designed to apply Harvest Tec buffered propionic acid.

Right and Left sides are determined by facing in the direction of forward travel.

Safety

Carefully read all the safety signs in this manual and on the applicator before use. Keep signs clean and in good working order. Replace missing or damaged safety signs. Replacement signs are available from your local authorized dealer. See your installation manual for under the replacement parts section for the correct part numbers.

Keep your applicator in proper working condition. Unauthorized modifications to the applicator may impair the function and/or safety of the machine.

Carefully read and understand all of the baler safety signs before installing or servicing the baler. Always use the supplied safety equipment on the baler to service the applicator.

Safety Sign Descriptions

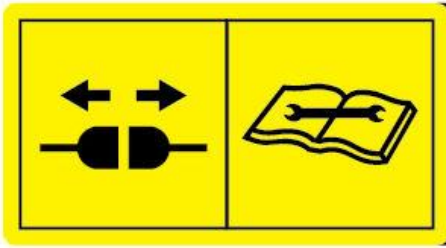

Number 1

Spraying hazard. Disconnect power before servicing the applicator

Part no. DCL-8003



Number 2

Use caution when working around chemicals. **Wear all protective equipment according to the label of the product.**

Part no. DCL-8001



Number 3

Read and understand the operator's manual before using or working around the equipment.

Part no. DCL-8000

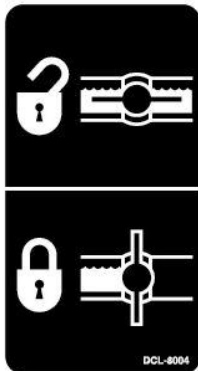

Number 4

Open (unlocked) and closed (locked) position of the ball valve.

Part no. DCL-8004

Preparing the Applicator for Operation

After the applicator has been installed on the baler, follow the below steps to prepare for operating the applicator both safely and correctly.

Filling the tank:

Model 431, 434, 440, 442 & 448

Read the label of the product being filled into the tank to determine what individual protective measures need to be taken. Locate the drain/fill line on the baler. Open the cam-couplers (A) and remove the protective plug (B). Insert the male coupler (found on transfer pump) into the female cam and close the cams (A). To open the ball valve (C) turn the handle so it is vertical. After the ball valve has been turned on switch the pump to the On position. Monitor the level on the tank visually and shut off the pump before over filling. Once the pump is turned off, close the ball valve and remove the male coupler. The handle of the ball valve (C) will be horizontal when closed. Reinstall the protective plug and close the cams. The Harvest Tec model 9212 transfer pump is recommended for this process.

Water is recommended for first time and annual start up procedures.



Drain/Fill line on the baler

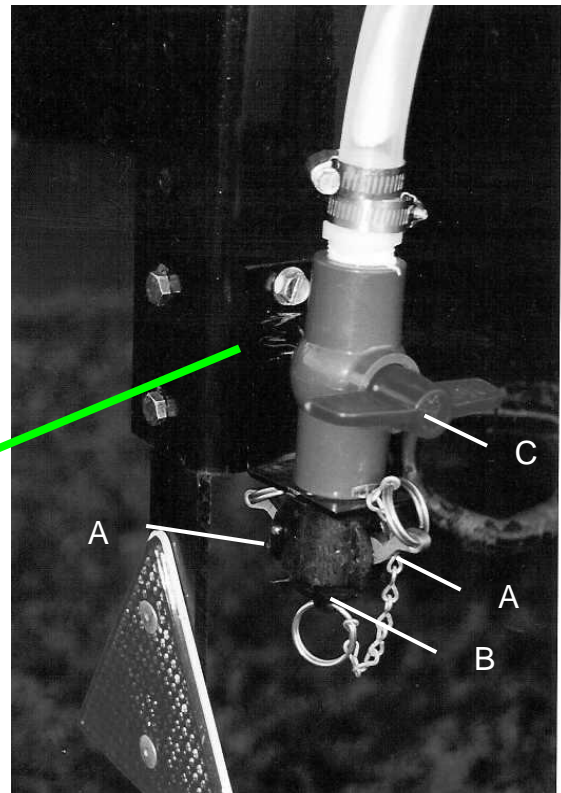

Enlarged view of the drain/fill line valve and cam-coupler assembly.

Filling the Tank

Model 431 & 441

Read the label of the product being filled into the tank to determine what individual protective measures need to be taken. Clean the tank lid area and unscrew the lid. Transfer product from the container into the tank.

Water is recommended for first time and annual start up procedures.

Operation of the main ball valve

The ball valve should be closed at all times when the applicator is not being used. The valve should also be closed when any service work is being done to the baler or applicator.

The valve is located next to the pump and by the applicator tank. The arrow below points at the valve.

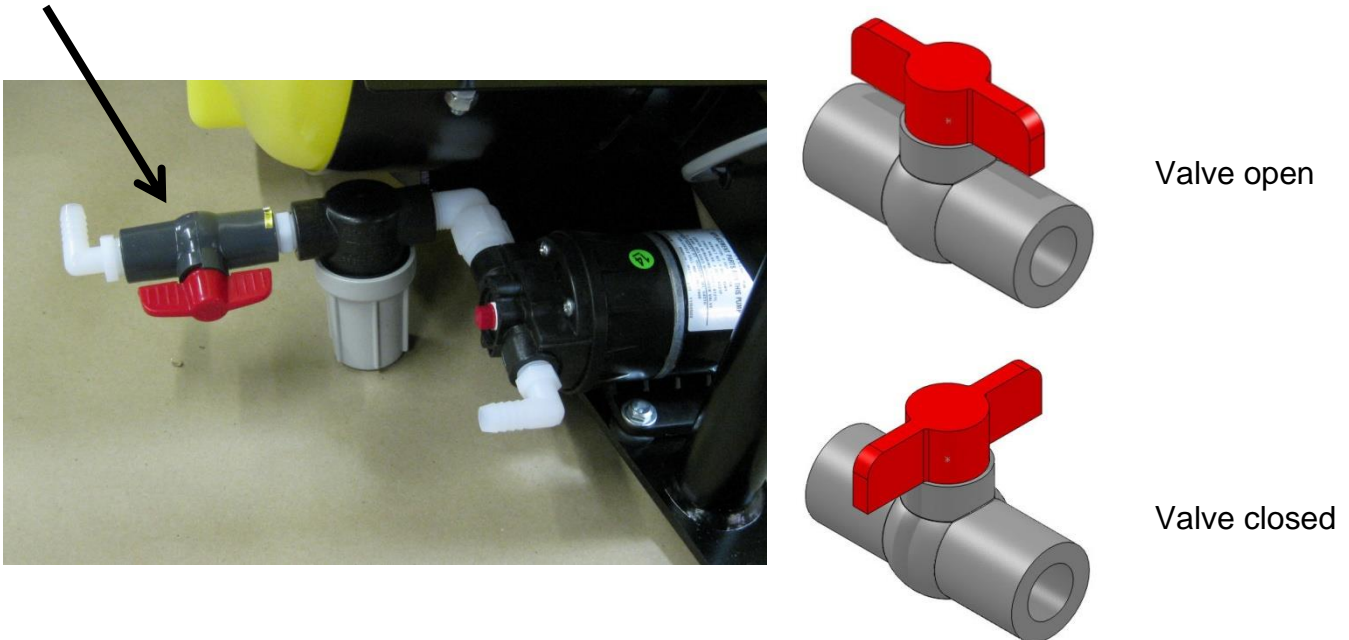

Connecting the power harness

The power harness that supplies power from the tractor battery to the applicator pump has a disconnect at the hitch. Connect the two together for operation. Always disconnect before servicing the applicator or baler.

Operation of the 457 Control Box

Understanding and using the 457 Control Box

The model 457 control box is pictured below. The toggle switch (A) is used to supply and cut off power to the pump. With the switch in down (shown) the power is off. Lift the switch up to supply power. The dial (B) is used to adjust the pressure to the tips when power is applied. Use the numbers on the dial only as reference. The PSI on the gauge determines the exact flow. Apply the correct rate decal found with your manual to the front of the control box. The message light (C) will always be illuminated when the power is on. If the light ever blinks during operation please reference the manual section "Message light".

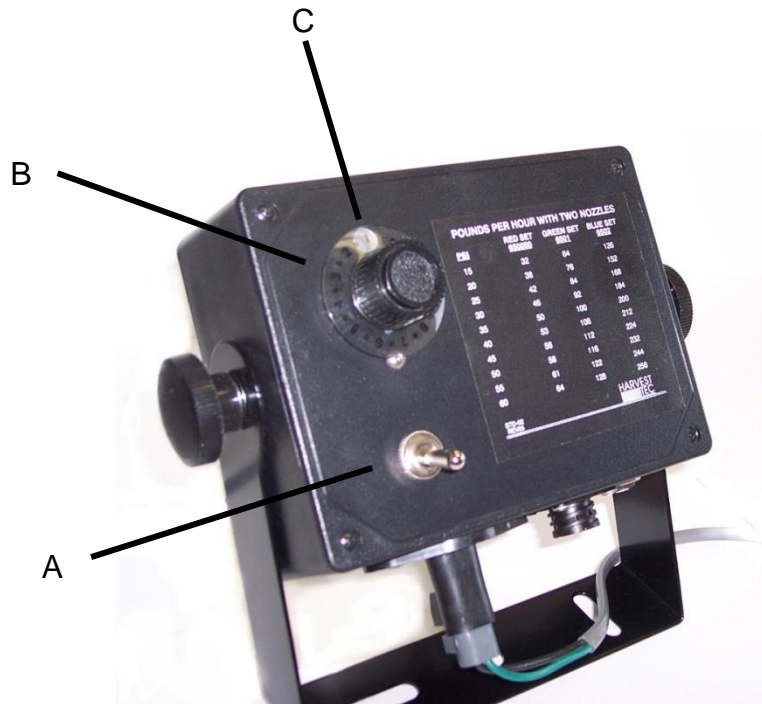

Message Light

The LED under the speed dial will be steady on when the applicator is running under normal situations. If the light blinks on and off, use the information noted below to decipher the message.

Slow steady on and off blink: The system is attached to hay indicators (474A) or a foot switch. This message means that the pump is paused. The light will come on constant once the baler is back in the windrow.

Two quick blinks: The pump motor or pump harness is shorted.

Three quick blinks: Pump motor is over the current limit (10 amps).

Four quick blinks: Power is under current from a bad connection.

The control box must have the on/off switch toggled to clear the message after the fault has been fixed to clear.

First Time and Annual Start Up

After familiarizing yourself with the model 457 control box, fill the tank with 5 gallons of water. Turn on the power to the pump by pushing the toggle switch up. You might hear the buzzing of the motor. Turn the dial on the control box until the pressure gauge starts to climb. By turning the dial clockwise the pressure will go up. By turning the dial counter clockwise the pressure will decrease. With the applicator spraying at about 30 PSI, look for leaks at all the hose connections and fittings. When you are comfortable with the operation of the controls you can set the applicator to apply the amount of chemical you would like it to put on.

Field Operation

Calibration

There are three things that you need to know when calibrating your applicator. First you need know how many tons per hour you bale. Second you need to know the rate, or how many pounds of product to apply for a given tons per hour. Finally you need to know what tips to use and at what pressure to set the gauge.

Determining tons per hour for small square balers (two tie)

1. Bale for three minutes.
2. Count the number of bales made in those three minutes.
3. Weigh several bales to determine the average weight.
4. Use the bale rate chart on the following page to determine the tons you are baling per hour.

Example: You baled 11 bales in three minutes. After weighing some of the bales you found the average bale weight to be 55 lbs. Using the following chart cross reference 11 bales and 55lbs and you will find the rate to be 6.0 tons per hour.

CONVENTIONAL BALE RATE CHART (TONS PER HOUR)

BALES MADE IN 3 MINUTES	WEIGHT PER BALE								
	40#	45#	50#	55#	60#	65#	70#	75#	80#
9	3.6	4.0	4.5	5.0	5.4	5.8	6.3	6.7	7.2
10	4.0	4.0	5.0	5.5	6.0	6.5	7.0	7.5	8.0
11	4.4	5.0	5.5	6.0	6.6	7.1	7.7	8.2	8.8
12	4.8	5.4	6.0	6.6	7.2	7.8	8.4	9.0	9.6
13	5.2	5.8	6.5	7.1	7.8	8.4	9.1	9.7	10.4
14	5.6	6.3	7.0	7.7	8.4	9.1	9.8	10.5	11.2
15	6.0	6.7	7.5	8.2	9.0	9.7	10.7	11.2	12.0
16	6.4	7.2	8.0	8.8	9.6	10.4	11.2	12.0	12.8
17	6.8	7.6	8.5	9.3	10.2	11.0	11.9	12.7	13.6
18	7.2	8.1	9.0	9.9	10.8	11.7	12.6	13.5	14.4
19	7.6	8.5	9.5	10.4	11.4	12.3	13.3	14.2	15.2
20	8.0	9.0	10.0	11.0	12.0	13.0	14.0	15.0	16.0

Determining tons per hour for small square balers (three tie)

1. Bale for three minutes.
2. Count the number of bales made in those three minutes.
3. Weigh several bales to determine the average weight.
4. Use the bale rate chart on the following page to determine the tons you are baling per hour.

Example: You baled 11 bales in three minutes. After weighing some of the bales you found the average bale weight to be 90 lbs. Using the following chart cross reference 11 bales and 90lbs and you will find the rate to be 9.9 tons/hr.

Bales Made in Three Minutes	Three Tie Bale Rate Chart (Tons per Hour)								
	Weight per Baler								
	70	75	80	85	90	100	110	120	130
6	4.2	4.5	4.8	5.1	5.4	6.0	6.6	7.2	7.8
7	4.9	5.3	5.6	6.0	6.3	7.0	7.7	8.4	9.1
8	5.6	6.0	6.4	6.8	7.2	8.0	8.8	9.6	10.4
9	6.3	6.8	7.2	7.7	8.1	9.0	9.9	10.8	11.7
10	7.0	7.5	8.0	8.5	9.0	10.0	11.0	12.0	13.0
11	7.7	8.3	8.8	9.4	9.9	11.0	12.1	13.2	14.3
12	8.4	9.0	9.6	10.2	10.8	12.0	13.2	14.4	15.6
13	9.1	9.8	10.4	11.1	11.7	13.0	14.3	15.6	16.9
14	9.8	10.5	11.2	11.9	12.6	14.0	15.4	16.8	18.2
15	10.5	11.3	12.0	12.8	13.5	15.0	16.5	18.0	19.5
16	11.2	12.0	12.8	13.6	14.4	16.0	17.6	19.2	20.8
17	11.9	12.8	13.6	14.5	15.3	17.0	18.7	20.4	22.1
18	12.6	13.5	14.4	15.3	16.2	18.0	19.8	21.6	23.4
19	13.3	14.3	15.2	16.2	17.1	19.0	20.9	22.8	24.7
20	14.0	15.0	16.0	17.0	18.0	20.0	22.0	24.0	26.0
21	14.7	15.8	16.8	17.9	18.9	21.0	23.1	25.2	27.3
22	15.4	16.5	17.6	18.7	19.8	22.0	24.2	26.4	28.6
23	16.1	17.3	18.4	19.6	20.7	23.0	25.3	27.6	29.9
24	16.8	18.0	19.2	20.4	21.6	24.0	26.4	28.8	31.2
25	17.5	18.8	20.0	21.3	22.5	25.0	27.5	30.0	32.5
26	18.2	19.5	20.8	22.1	23.4	26.0	28.6	31.2	33.8
27	18.9	20.3	21.6	23.0	24.3	27.0	29.7	32.4	35.1
28	19.6	21.0	22.4	23.8	25.2	28.0	30.8	33.6	36.4
29	20.3	21.8	23.2	24.7	26.1	29.0	31.9	34.8	37.7
30	21.0	22.5	24.0	25.5	27.0	30.0	33.0	36.0	39.0
31	21.7	23.3	24.8	26.4	27.9	31.0	34.1	37.2	40.3
32	22.4	24.0	25.6	27.2	28.8	32.0	35.2	38.4	41.6
33	23.1	24.8	26.4	28.1	29.7	33.0	36.3	39.6	42.9
34	23.8	25.5	27.2	28.9	30.6	34.0	37.4	40.8	44.2
35	24.5	26.3	28.0	29.8	31.5	35.0	38.5	42.0	45.5

Determining tons per hour for round balers

1. Time 3 bales and average the time it takes to make a bale.
2. Estimate the weight of the bale.
3. Use the bale rate chart below to determine the tons you are baling per hour.

Example: You made 3 round bales and it took you an average of 2 minutes a piece to bale each of them. Your baler's operator manual tells you that an average bale made by your machine weighs 1000lb. (Remember if the hay is dry it will weigh less and if the hay is wet it will weigh more.) Using the chart below, cross-reference 2 minutes with 1000lb. and you will come up with 15 ton per hour.

Average time to make a bale (min.)	Round Baler (Tons per Hour)								
	Weight per Baler								
	600	800	1000	1200	1400	1600	1800	2000	2200
0.5	36.0	48.0	60.0	72.0	84.0	96.0	108.0	120.0	132.0
1	18.0	24.0	30.0	36.0	42.0	48.0	54.0	60.0	66.0
1.5	12.0	16.0	20.0	24.0	28.0	32.0	36.0	40.0	44.0
2	9.0	12.0	15.0	18.0	21.0	24.0	27.0	30.0	33.0
2.5	7.2	9.6	12.0	14.4	16.8	19.2	21.6	24.0	26.4
3	6.0	8.0	10.0	12.0	14.0	16.0	18.0	20.0	22.0
3.5	5.1	6.9	8.6	10.3	12.0	13.7	15.4	17.1	18.9
4	4.5	6.0	7.5	9.0	10.5	12.0	13.5	15.0	16.5
4.5	4.0	5.3	6.7	8.0	9.3	10.7	12.0	13.3	14.7
5	3.6	4.8	6.0	7.2	8.4	9.6	10.8	12.0	13.2
5.5	3.3	4.4	5.5	6.5	7.6	8.7	9.8	10.9	12.0
6	3.0	4.0	5.0	6.0	7.0	8.0	9.0	10.0	11.0
6.5	2.8	3.7	4.6	5.5	6.5	7.4	8.3	9.2	10.2
7	2.6	3.4	4.3	5.1	6.0	6.9	7.7	8.6	9.4
7.5	2.4	3.2	4.0	4.8	5.6	6.4	7.2	8.0	8.8
8	2.3	3.0	3.8	4.5	5.3	6.0	6.8	7.5	8.3
8.5	2.1	2.8	3.5	4.2	4.9	5.6	6.4	7.1	7.8
9	2.0	2.7	3.3	4.0	4.7	5.3	6.0	6.7	7.3
9.5	1.9	2.5	3.2	3.8	4.4	5.1	5.7	6.3	6.9
10	1.8	2.4	3.0	3.6	4.2	4.8	5.4	6.0	6.6

Determining the rate of chemical

The number of pounds of chemical required to be applied to a given ton of hay, depends on the moisture and the type of chemical used. The moisture of the hay is important in determining how much chemical to use. The wetter the hay the more product needed, the dryer the hay the less product is needed. By knowing the moisture, you can make sure you are treating the hay correctly. Under applying will save money but spoilage most likely occurs. Over applying will waste money however, the hay will be saved. Some chemicals require more or less to treat the same amount of hay. To find the exact number of pounds required, for a given hay moisture, refer to the label on the drum or contact the manufacture. Harvest Tec applicators come with low, medium, and high sets of tips. If your chemical requires rates other than what these tips deliver you will need to purchase them through your dealer.

Selecting tips and setting pressure for two and three tie small square balers

Once you have determined your tons per hour and the amount of chemical needed for the moisture you are applying at, you can select your tips and determine your gauge settings.

1. Multiply the tons per hour by the amount of chemical required for the moisture you are applying at. This sum will give you the application rate.
2. Select the proper set of tips from the application rate chart and install them. (Pg.19-20)
3. For the tips you have selected, you will need to keep the gauge at the recommended PSI to achieve the proper application rate.
4. Set the pressure by adjusting the dial on the control box and by reading the pressure of the gauge to match the desired rates. The numbers on the dial are for reference only. Rate is determined by watching the pressure gauge.

Example: You are baling at 12.5 tons per hour with your conventional square baler. The moisture t you are baling at requires you to apply 8 pounds per ton. Multiply the 12.5 tons x 8lbs. = 100lbs. per hour. Using the chart, lbs/hr with two nozzles, found on page 22 and 23 of this manual, you will notice the medium or pink set of tips at 35 PSI will give you that output.

Calibration reminders

*Watch the pressure gauge, as the setting will vary with tractor's electrical output, temperature and other factors.

*Check your application rate by measuring product used against actual tons baled.

REMEMBER, ONLY YOU CAN CONTROL HOW MUCH PRODUCT IS APPLIED AND THAT WILL DETERMINE IF YOUR HAY WILL KEEP!!!

Selecting tips and setting pressure for round balers

Once you have determined your tons per hour and the amount of chemical needed for the moisture you are applying at, you can select your tips and determine your gauge settings.

1. Multiply the tons per hour by the amount of chemical required for the moisture you are applying at. This sum will give you the application rate.
2. Select the proper set of tips from the application rate chart and install them. (Pg.21)
3. For the tips you have selected, you will need to keep the gauge at the recommended PSI to achieve the proper application rate.
4. Set the pressure by adjusting the dial on the control box and by reading the pressure of the gauge to match the desired rates. The numbers on the dial are for reference only. Rate is determined by watching the pressure gauge.

Example: You are baling at 22 tons per hour with your round baler. The moisture you are baling at requires you to apply 8 pounds per ton. Multiply the 22 tons x 8lbs. = 176lbs. per hour. Using the chart, lbs/hr with three nozzles, found on page 24 of this manual, you will notice the green set of tips at 35 PSI will give you that output.

Calibration reminders

*Watch the pressure gauge, as the setting will vary with tractor's electrical output, temperature and other factors.

*Check your application rate by measuring product used against actual tons baled.

REMEMBER, ONLY YOU CAN CONTROL HOW MUCH PRODUCT IS APPLIED AND THAT WILL DETERMINE IF YOUR HAY WILL KEEP!!!

GENERAL CALIBRATION CHART FOR ONE NOZZLE

Use the following chart for install kit 4415 & 4415-SO

POUNDS PER HOUR WITH ONE NOZZLE

PSI	INCLUDED IN KIT			
	<i>Blue</i>	LOW <i>Orange</i>	MEDIUM <i>Blue</i>	HIGH <i>Yellow</i>
	TX-SS-4	TX-SS-6	TX-SS-12	TX-SS-26
15	21 (9.5L)	32 (14.4L)	64 (28.8L)	105 (47.3L)
20	25 (11.2L)	38 (17.1L)	76 (34.2L)	120 (54L)
25	28 (12.6L)	42 (19L)	84 (37.8L)	135 (60.8L)
30	30 (13.5L)	46 (20.7L)	92 (41.4L)	145 (65.3L)
35	33 (14.5L)	50 (22.5L)	100 (45L)	165 (74.3L)
40	35 (15.8L)	53 (23.9L)	106 (47.7L)	174 (78.3L)
45	37 (16.7L)	56 (25.2L)	112 (50.4L)	185 (83.3L)
50	38 (17.1L)	58 (26.1L)	116 (52.2L)	195 (87.8L)
55	40 (18L)	61 (27.5L)	122 (54.9L)	200 (90L)
60	42 (19L)	64 (28.8L)	128 (57.6L)	210 (94.5L)

GALLONS PER HOUR WITH ONE NOZZLE

PSI	INCLUDED IN KIT			
	<i>Blue</i>	LOW <i>Orange</i>	MEDIUM <i>Blue</i>	HIGH <i>Yellow</i>
	TX-SS-4	TX-SS-6	TX-SS-12	TX-SS-26
15	2.4 (9.1L)	3.6 (13.6L)	7.2 (27.2L)	11.9 (45L)
20	2.6 (9.8L)	4.2 (15.9L)	8.6 (32.5L)	13.6 (51.4L)
25	3.2 (12.1L)	4.6 (17.4L)	9.4 (35.5L)	15.3 (57.8L)
30	3.4 (12.9L)	5.2 (19.7L)	10.4 (39.3L)	16.4 (62L)
35	3.8 (14.4L)	5.6 (21.2L)	11.2 (42.3L)	18.7 (70.7L)
40	4.0 (15.1L)	6.0 (22.7L)	12.0 (45.4L)	19.7 (74.5L)
45	4.2 (15.9L)	6.2 (23.4L)	12.8 (48.4L)	21.0 (79.4L)
50	4.4 (16.7L)	6.6 (24.9L)	13.4 (50.7L)	22.1 (83.5L)
55	4.6 (17.4L)	7.0 (26.5L)	14.0 (52.9L)	22.7 (85.8L)
60	4.8 (18.2L)	7.2 (27.2L)	14.8 (55.9L)	23.8 (90L)

GENERAL CALIBRATION CHART FOR TWO NOZZLES

Use the following chart for install kits 4409, 4410, 4416, 4482, 4485, 4502, 4506, 4507, & 4546

POUNDS PER HOUR WITH TWO NOZZLES

	INCLUDED IN KIT				
	<i>Silver</i> T650033-SS	LOW <i>Silver</i> T650050-SS	MEDIUM <i>Pink/Gray</i> T6501-PT	HIGH <i>Orange/Gray</i> T6502-PT	
PSI					
15	21 (9.5L)	32 (14.4L)	64 (28.8L)	128 (57.6L)	192 (86.4L)
20	25 (11.2L)	38 (17.1L)	76 (34.2L)	152 (68.L)	228 (102.6L)
25	28 (12.6L)	42 (19L)	84 (37.8L)	168 (75.6L)	252 (113.4L)
30	30 (13.5L)	46 (20.7L)	92 (41.4L)	184 (82.8L)	276 (124.2L)
35	33 (14.5L)	50 (22.5L)	100 (45L)	200 (90L)	300 (135L)
40	35 (15.8L)	53 (23.9L)	106 (47.7L)	212 (95.4L)	318 (143.1L)
45	37 (16.7L)	56 (25.2L)	112 (50.4L)	224 (100.8L)	336 (151.2L)
50	38 (17.1L)	58 (26.1L)	116 (52.2L)	232 (104.4L)	348 (156.6L)
55	40 (18L)	61 (27.5L)	122 (54.9L)	244 (109.8L)	366 (164.7L)
60	42 (19L)	64 (28.8L)	128 (57.6L)	256 (115.2L)	384 (172.8L)

GALLONS PER HOUR WITH TWO NOZZLES

	INCLUDED IN KIT				
	<i>Silver</i> T650033-SS	<i>Silver</i> T650050-SS	<i>Pink/Gray</i> T6501-PT	<i>Orange/Gray</i> T6502-PT	
PSI					
15	2.4 (9.1L)	3.6 (13.6L)	7.2 (27.2L)	14.4 (54.4L)	21.6 (81.6L)
20	2.6 (9.8L)	4.2 (15.9L)	8.6 (32.5L)	17.2 (65L)	25.8 (97.5L)
25	3.2 (12.1L)	4.6 (17.4L)	9.4 (35.5L)	18.8 (71.1L)	28.2 (106.6L)
30	3.4 (12.9L)	5.2 (19.7L)	10.4 (39.3L)	20.8 (78.6L)	31.2 (117.9L)
35	3.8 (14.4L)	5.6 (21.2L)	11.2 (42.3L)	22.4 (84.7L)	33.6 (127L)
40	4.0 (15.1L)	6.0 (22.7L)	12.0 (45.4L)	24.0 (90.7L)	36.0 (136.1L)
45	4.2 (15.9L)	6.2 (23.4L)	12.8 (48.4L)	25.6 (96.8L)	38.4 (145.2L)
50	4.4 (16.7L)	6.6 (24.9L)	13.4 (50.7L)	26.8 (101.3L)	40.2 (152L)
55	4.6 (17.4L)	7.0 (26.5L)	14.0 (52.9L)	28.0 (105.8L)	42.0 (158.8L)
60	4.8 (18.2L)	7.2 (27.2L)	14.8 (55.9L)	29.6 (111.9L)	44.4 (167.8L)

CALIBRATION CHART FOR JOHN DEERE 8 & 9 SERIES, VERMEER 445Z

Use the following chart for install kits 4516, 4517, 445Z Baler

POUNDS PER HOUR WITH TWO NOZZLES

	Yellow 800067	INCLUDED IN KIT			Black XR11001
		Red XR11001	Green XR11002	Blue XR11003	
PSI					
15	53 (23.9L)	64 (28.8L)	112 (50.4L)	192 (86.4L)	320 (144L)
20	63 (28.4L)	76 (34.2L)	133 (59.9L)	228 (102.6L)	380 (171L)
25	70 (31.5L)	84 (37.8L)	147 (66.2L)	252 (113.4L)	420 (189L)
30	77 (34.7L)	92 (41.4L)	161 (72.5L)	276 (124.2L)	460 (207L)
35	84 (37.8L)	100 (45L)	175 (78.8L)	300 (135L)	N/A
40	89 (40.1L)	106 (47.7L)	186 (83.7L)	318 (143.1L)	N/A
45	94 (42.3L)	112 (50.4L)	196 (88.2L)	336 (151.2L)	N/A
50	97 (43.7L)	116 (52.2L)	203 (91.4L)	348 (156.6L)	N/A
55	102 (45.9L)	122 (54.9L)	214 (96.3L)	366 (164.7)	N/A
60	107 (128L)	128 (57.6L)	224 (100.8L)	384 (172.8L)	N/A

GALLONS PER HOUR WITH TWO NOZZLES

	Yellow 800067	INCLUDED IN KIT			Black XR11005
		Red XR11001	Green XR11002	Blue XR11003	
PSI					
15	5.2 (19.7L)	7.3 (27.6L)	12.9 (48.8L)	22.0 (83.2L)	31.9 (120.6L)
20	5.6 (21.2L)	8.4 (31.8L)	15.1 (57.1L)	24.1 (91.1L)	42.2 (159.5L)
25	6.3 (23.8L)	9.5 (35.9L)	16.7 (63.1L)	28.3 (107L)	47.3 (178.8L)
30	7.0 (26.5L)	10.6 (40.1L)	18.6 (70.3L)	31.0 (117.2L)	52.2 (197.3L)
35	7.5 (28.4L)	11.3 (42.7)	19.7 (74.5L)	33.5 (126.6L)	N/A
40	8.0 (30.2L)	12.0 (45.4L)	21.0 (79.4L)	36.0 (136.1L)	N/A
45	8.4 (31.8L)	12.6 (47.6L)	22.3 (84.3L)	38.3 (144.8L)	N/A
50	8.9 (33.6L)	13.2 (49.9L)	23.6 (89.2L)	40.7 (153.8L)	N/A
55	9.3 (35.2L)	13.8 (52.2L)	24.5 (92.6L)	42.5 (160.7L)	N/A
60	9.7 (36.7L)	14.4 (54.4L)	25.6 (96.8L)	44.4 (167.8L)	N/A

GENERAL CALIBRATION CHART FOR THREE NOZZLES

Use the following chart for all install kits 442-SO, 4483, 4484, 4486, 4503, 4504, 4505, 4508, 4516, 4517, 4523, 4524, and 4400C

POUNDS PER HOUR WITH THREE NOZZLES

	Yellow 650067 650033	INCLUDED IN KIT			Black XR11004 6503	CENTER OUTSIDE
		Red XR11001 650050	Green XR110015 6501	Blue XR11002 6502		
		PSI				
15	53 (23.9L)	64 (28.8L)	112 (50.4L)	192 (86.4L)	320 (144L)	
20	63 (28.4L)	76 (34.2L)	133 (59.9L)	228 (102.6L)	380 (171L)	
25	70 (31.5L)	84 (37.8L)	147 (66.2L)	252 (113.4L)	420 (189L)	
30	77 (34.7L)	92 (41.4L)	161 (72.5L)	276 (124.2L)	460 (207L)	
35	84 (37.8L)	100 (45L)	175 (78.8L)	300 (135L)	N/A	
40	89 (40.1L)	106 (47.7L)	186 (83.7L)	318 (143.1L)	N/A	
45	94 (42.3L)	112 (50.4L)	196 (88.2L)	336 (151.2L)	N/A	
50	97 (43.7L)	116 (52.2L)	203 (91.4L)	348 (156.6L)	N/A	
55	102 (45.9L)	122 (54.9L)	214 (96.3L)	366 (164.7)	N/A	
60	107 (128L)	128 (57.6L)	224 (100.8L)	384 (172.8L)	N/A	

GALLONS PER HOUR WITH THREE NOZZLES

	Yellow 650067 650033	INCLUDED IN KIT			Black XR11004 6503	CENTER OUTSIDE
		Red XR11001 650050	Green XR110015 6501	Blue XR11002 6502		
		PSI				
15	5.2 (19.7L)	7.3 (27.6L)	12.9 (48.8L)	22.0 (83.2L)	31.9 (120.6L)	
20	5.6 (21.2L)	8.4 (31.8L)	15.1 (57.1L)	24.1 (91.1L)	42.2 (159.5L)	
25	6.3 (23.8L)	9.5 (35.9L)	16.7 (63.1L)	28.3 (107L)	47.3 (178.8L)	
30	7.0 (26.5L)	10.6 (40.1L)	18.6 (70.3L)	31.0 (117.2L)	52.2 (197.3L)	
35	7.5 (28.4L)	11.3 (42.7)	19.7 (74.5L)	33.5 (126.6L)	N/A	
40	8.0 (30.2L)	12.0 (45.4L)	21.0 (79.4L)	36.0 (136.1L)	N/A	
45	8.4 (31.8L)	12.6 (47.6L)	22.3 (84.3L)	38.3 (144.8L)	N/A	
50	8.9 (33.6L)	13.2 (49.9L)	23.6 (89.2L)	40.7 (153.8L)	N/A	
55	9.3 (35.2L)	13.8 (52.2L)	24.5 (92.6L)	42.5 (160.7L)	N/A	
60	9.7 (36.7L)	14.4 (54.4L)	25.6 (96.8L)	44.4 (167.8L)	N/A	

Maintenance

- If you are unsure how to perform any of the maintenance steps have your local authorized dealer perform the tasks.

Maintenance Schedule

	Daily	10 hrs	400 hrs	Weekly	Monthly	Season
Filter bowl cleaning		X				X
Tips & tip screen cleaning		X				X
Tank lid cleaning		X				X
Dielectric grease connections					X	X
Rebuild pump			X			
Battery connections				X		X
Visually inspect hoses				X		X

Filter bowl cleaning

Before cleaning the filter bowl all personal protective equipment must be worn (Face shield or goggles, chemically resistant apron, boots, and gloves).

Verify that the ball valve located next to the pump is turned off. Locate the filter bowl on the side of the pump manifold (A). Unscrew the bottom section of the filter bowl and remove the strainer. (B) Clean off any debris and soak in warm water with a mild soap if necessary. Once the screen is clean reinstall by following the directions in reverse.

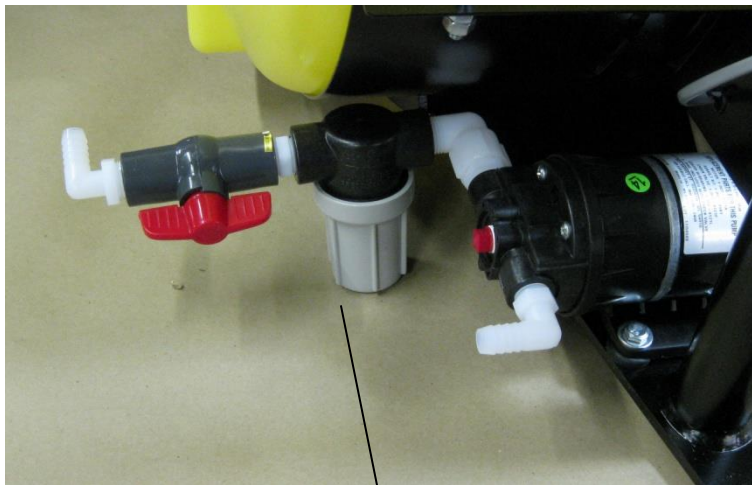

A



B

Tips & tip screen cleaning:

Before cleaning the tips and screens all personal protective equipment must be worn (Face shield or goggles, chemically resistant apron, boots, and gloves).

Verify that the ball valve located next to the pump is turned off. Disconnect spray shield from hangers if possible or remove tips in place. Remove the tip, and screen. Some models may require a wrench to remove. Clean off any debris and soak tip and screen in warm water with a mild soap if necessary. Once the tips and screens are cleaned reinstall by following the directions in reverse.

Tank lid cleaning

Before cleaning the tank lid all personal protective equipment must be worn (Face shield or goggles, chemically resistant apron, boots, and gloves).

The tank lid is located on the top of the tank. Use the supplied handle on the tank to secure your person and use the other hand to remove any debris from the top of the tank. Unscrew the tank lid and bring down ground level. Use compressed air clean out the tank screen (D). If the screen cannot be thoroughly cleaned with compressed air, replace fitting (005-9022B3). Once the screen is cleaned reinstall the cover.

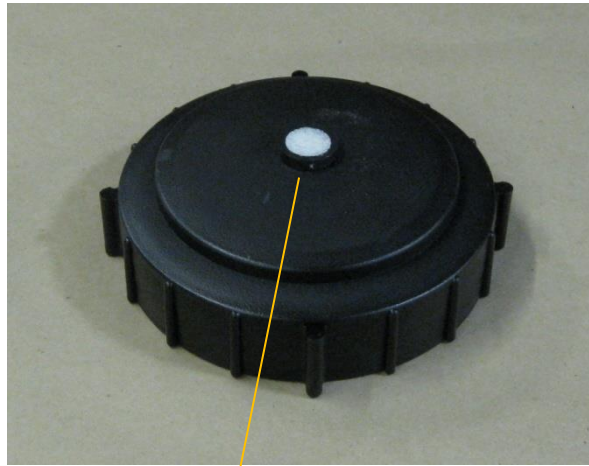

D

Dielectric grease connections

Disconnect all harnesses on the applicator, clean the connections, and repack with dielectric grease.

Rebuild pump

If the pump is not working up to specifications a pump rebuild kit may fix the problems.

Verify that the ball valve is turned off. Before working around the pump all personal protective equipment must be worn (Face shield or goggles, chemically resistant apron, boots, and gloves). Disconnect all pump fittings and remove pump from saddle. Follow rebuild instructions supplied with pump rebuild kit. Reinstall after rebuild is complete.

Battery connections

Follow the batteries safety warnings and clean the battery connections. If the connections cannot be cleaned, replace harness.

Miscellaneous maintenance:

1. Depending on the product being used, the system may need to be flushed with water at a regular interval (consult with manufacturer of the chemical.) If Harvest Tec product is being used, flushing is not necessary.
2. Although the pump can run dry, extended operation of a dry pump will increase wear. Watch the preservative level in the tank.
3. If you are using bacterial inoculants, flush your system daily after every use.

Winter Storage

1. Thoroughly flush the system with water.
2. Remove the filter bowl and run dry until the water has cleared out of the intake side.
3. Remove the red plug from the bottom of the pump, drain, and run the pump for 30 seconds or until it is dry.
4. Drain all lines on the outlet side.
5. Never use oils or alcohol based anti-freeze in the system.
6. For spring start-up, if the pump is frozen, turn off the power immediately to avoid burning the motor out or blowing a fuse. The pump head can be disassembled and freed or rebuilt in most cases. Check the fuses after the pump has been freed.
7. Disconnect power from the Precision Information Processor.
8. Remove display from tractor and store in a warm, dry place.

Troubleshooting Checks

Problem	Possible cause	Solution
Pump will not run.	1. Circuit breaker tripped on electronic unit.	1. Check for short, low voltage, and reset breaker.
	2. Pump locked up.	2. Clean or rebuild pump if motor is OK.
	3. Damaged wire.	3. Repair damaged wire.
Pump runs but will not prime.	1. Air leak in intake.	1. Tighten fittings on intake side.
	2. Clogged intake.	2. Clean.
	3. Restricted outlet.	3. Check and clean tips.
	4. Check valve on outlet stuck closed.	4. Clean or repair check valve.
	5. Dirt inside pump.	5. Replace pump check valve.
	6. Vapor locked.	6. Loosen hose by check valve at gauge and bleed air.
Pump does not develop enough output.	1. Air leaks or clogs on inlet side.	1. Tighten or clean filter bowl assembly.
	2. Electronic box out of adjustment.	2. Refer to box adjustment page.
	3. Pump worn or dirty.	3. Rebuild pump.
	4. Low supply voltage. (Pump requires 12v minimum)	4. Check voltage at connection with voltmeter.
	5. Bad gauge.	5. Gauge should read less than 10 PSI when not in use. Also tips should lose spray pattern below 10 PSI. Check accuracy.
Pump output varies.	1. Clogged or restricted inlet.	1. Clean
	2. Worn pump parts.	2. Rebuild pump.
Message light blinks two times	1. Pump or wire harness shorted.	1. Check harness running to pump and verify no shorts or problems. 2. Check to see if pump motor is locked up. Repair or replace.
Message light blinks three times	1. Pump is drawing greater than 10 amps.	1. Check to see if motor is running correctly. Repair or replace.
Message light blinks four times	1. Undercurrent coming to control box.	1. Check all battery connections and connections running up to control box.

Parts Breakdowns for Base Kits

Model 431 Base Kit

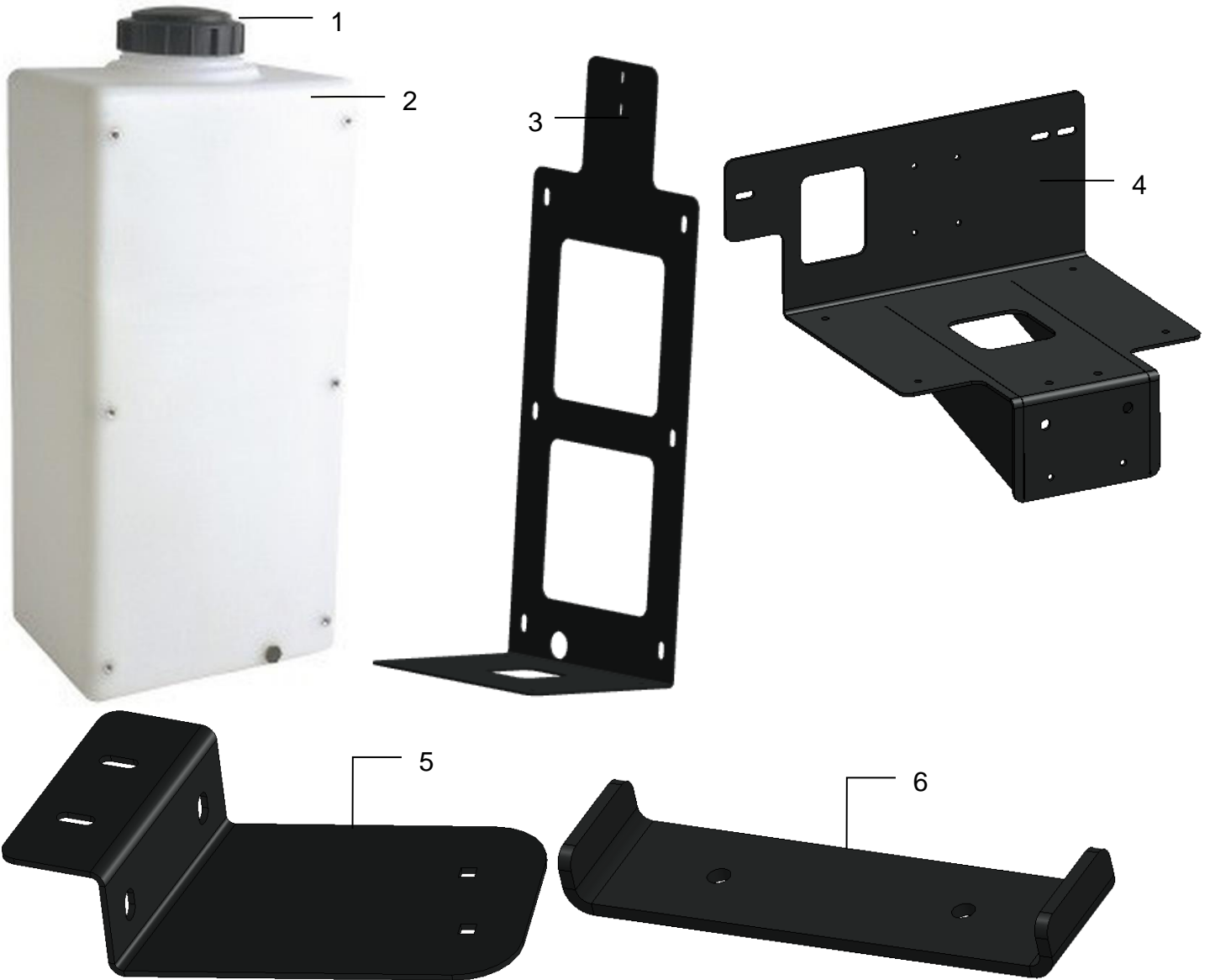

<u>Ref</u>	<u>Description</u>	<u>Part #</u>	<u>Qty</u>	<u>Ref</u>	<u>Description</u>	<u>Part #</u>	<u>Qty</u>
1	Tank Cap	005-9022C	1	8	Inside Reach Rod	001-4405	2
2	20 Gallon Tank	005-4705T	1	NP	3/4" Tank Fitting	005-9100	2
3	20 Gal Tank Bracket	001-4705A	1	NP	3/4" Street Fitting	003-SE34	1
4	20 Gal Tank Frame	001-4705B	1	NP	3/4" x 3/4" Elbow	003-EL3434	1
5	20 Gal Platform Bracket	001-4705C	1	NP	Cap Gasket (included)	005-9022CG	1
6	20 Gal Platform Standoff	001-4705D	1	NP	U-Bolt - Small	001-4714UBS	1
7	Outside Reach Rod	001-4404	2				
					Complete Kit	030-0431-TK	



Model 434 Base Kit

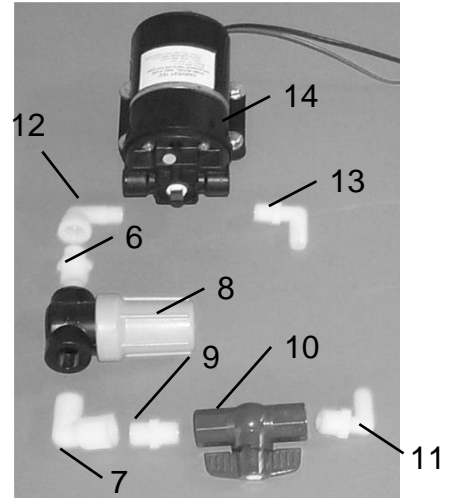
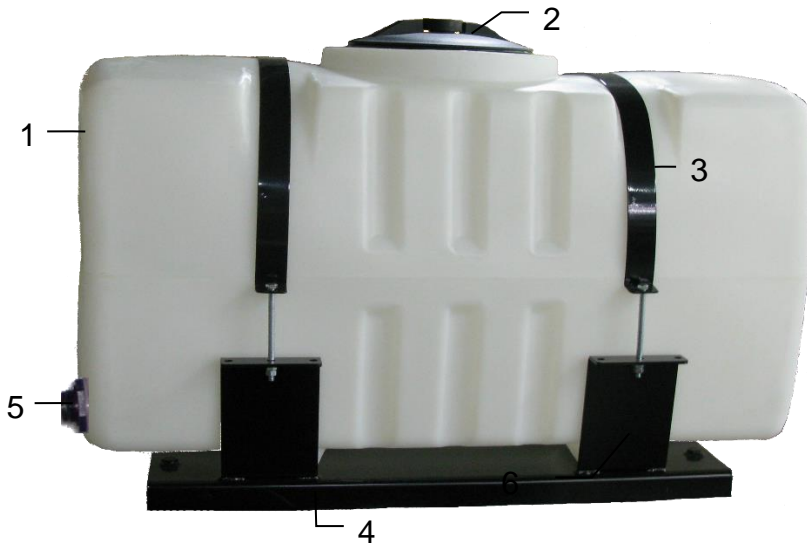

<u>Ref</u>	<u>Description</u>	<u>Part#</u>	<u>Qty</u>	<u>Ref</u>	<u>Description</u>	<u>Part#</u>	<u>Qty</u>
1	Tank	005-9203SQ	1	8	Filter bowl	002-4315-80	1
2	Tank lid	005-9022H	1	9	Nipple	003-M1212	1
3	Tank straps	001-4402	2	10	Ball valve	002-2212	1
4	Tank Saddle	001-4703X	1	11	Elbow	003-EL1212	1
5	Tank fitting	005-9100	2	12	Elbow	003-SE38	1
6	Nipple	003-M1238	1	13	Elbow	003-EL3812	1
7	Elbow	003-SE12	2	14	Pump	007-4120S	1

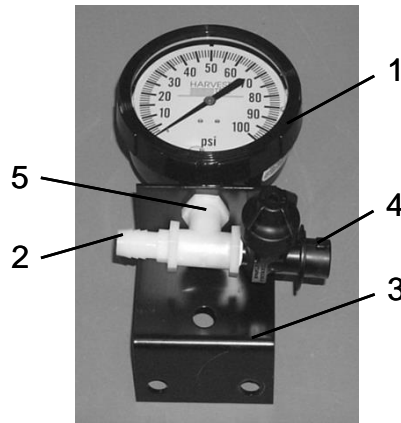

<u>Ref #</u>	<u>Description</u>	<u>Part #</u>	<u>Qty</u>	<u>Ref #</u>	<u>Description</u>	<u>Part #</u>	<u>Qty</u>
1	Gauge	002-2208Z	1	4	Check Valve	004-1207V	1
2	Straight Fitting	003-A1212	1	5	Tee	004-TT14	1
3	Gauge Bracket	001-4714	1				

Model 440 Base Kit

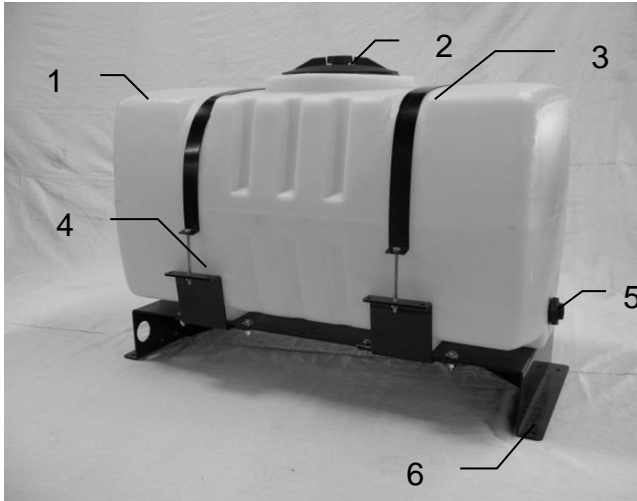

Gauge Assembly for 440

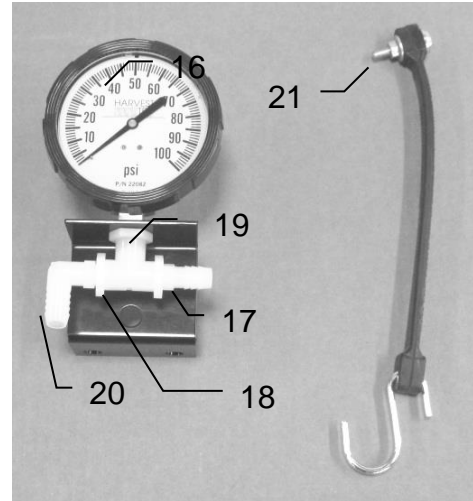

Parts Bag for 440

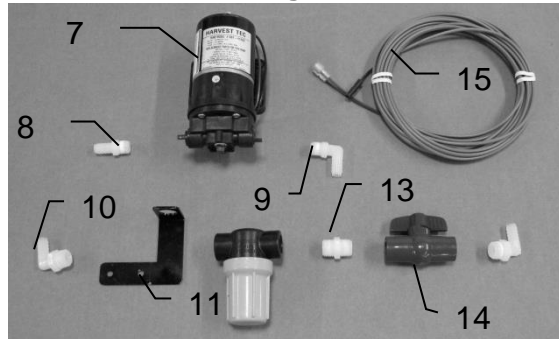

<u>Ref</u>	<u>Description</u>	<u>Part#</u>	<u>Qty</u>	<u>Ref</u>	<u>Description</u>	<u>Part#</u>	<u>Qty</u>
1	Tank	005-9203SQ	1	14	Ball valve	002-2212	1
2	Tank lid	005-9022G	1	15	Pump lead	006-4574	1
3	Tank straps	001-4402	2	16	Gauge	002-2208Z	1
4	Short strap base	001-4703CC	2	17	Straight fitting	003-A1412	2
NP	Long strap base	001-4703CD	2	18	Tee	003-TT14	1
5	Tank fitting	005-9100	2	19	Gauge bracket	001-4717	1
6	Tank saddle	001-4703C	1	20	Elbow	003-EL1412	1
7	Pump	007-4120S	1	21	Door latch	001-4703CL	1
8	Straight fitting	003-A3812	1	22	Pump lead	006-4583	1
9	Elbow	003-EL3812	1	NP	#6 Hose clamp	003-9003	7
10	Elbow	003-EL1212	2	NP	Screen-80 mesh	002-4315B	1
11	Filter bowl assembly	002-4315	1	NP	Filter bowl only	002-4315F	1
12	Filter holder	001-4703CH	1	NP	Filter bowl gasket	002-4315D	1
13	Nipple	003-M1212	1				
				NP	Not Pictured		

Model 441 Base Kit

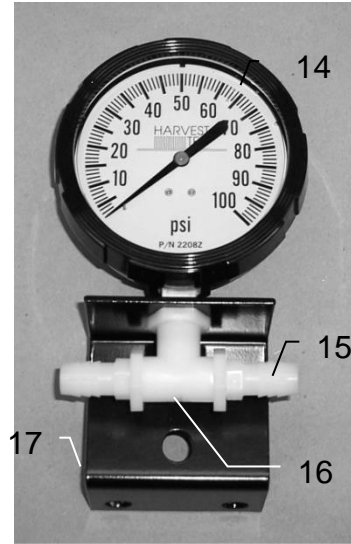
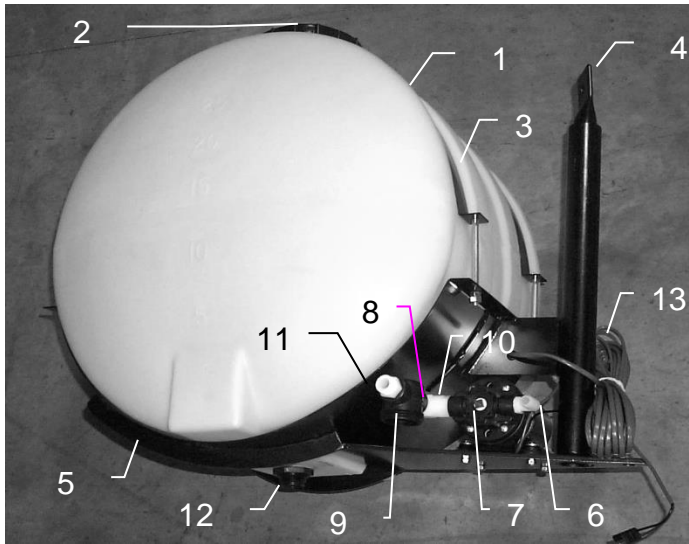

Gauge Assembly for 441

Parts Bag for 441

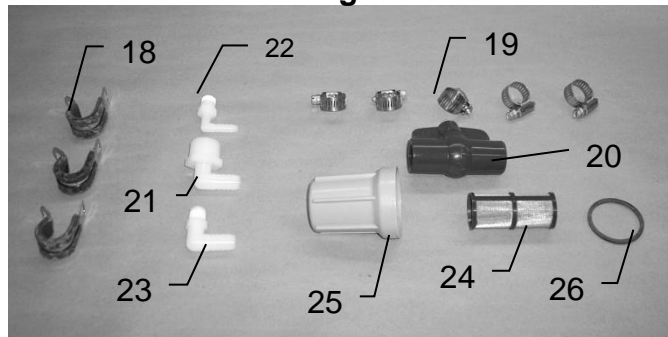

<u>Ref</u>	<u>Description</u>	<u>Part #</u>	<u>Qty</u>	<u>Ref</u>	<u>Description</u>	<u>Part #</u>	<u>Qty</u>
1	Tank-25 gallon	005-9022	1	14	Gauge	002-2208Z	1
2	Tank lid – 1999 or older	005-9022A	1	15	Straight fitting	003-A1412	2
	Tank lid – 2000 or newer	005-9022C					
3	Tank strap	001-4402	2	16	Tee	003-TT14	1
4	Stub pipe	001-4403	1	17	Gauge bracket	001-4717	1
5	Tank frame	001-4401	1	18	Jiffy clips	008-9010	3
6	Elbow	003-EL3812	1	19	#6 Hose clamp	003-9003	5
7	Pump	007-4120S	1	20	Ball valve-1/2"	002-2212	1
8	Elbow	003-SE12	1	21	Elbow	003-EL3412	1
9	Filter bowl assembly	002-4315	1	22	Elbow	003-EL1412	1
10	Nipple	003-M1238	1	23	Elbow	003-EL1212	1
11	Nipple	003-M1212	1	24	Screen-80 mesh	002-4315B	1
12	Tank fitting	005-9100	1	25	Filter bowl only	002-4315F	1
13	Pump lead	006-4574	1	26	Filter bowl gasket	002-4315D	1

Model 442 Base Kit

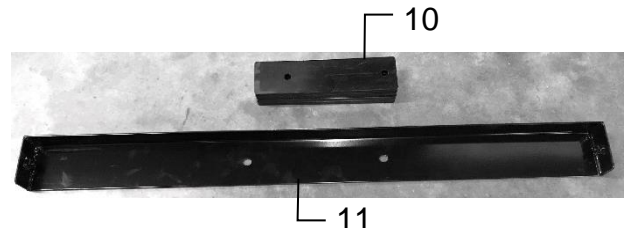

<u>Ref</u>	<u>Description</u>	<u>Part#</u>	<u>Qty</u>	<u>Ref</u>	<u>Description</u>	<u>Part#</u>	<u>Qty</u>
1	25 gallon tank	005-9022	1	8	Tank fitting	005-9100	1
2	25 gallon saddle	001-4442	1	9	Cross support (55 gallon only)	001-4445B	1
3	55 gallon tank	005-9203	1				
4	55 gallon saddle	001-4445A	1				
5	Tank strap	001-4402	2		<i>4' CNH Twine Only Balers</i>		
6	Tank lid	005-9022C	1	10	BR Spacer	001-4442S	4
7	Tank lid gasket	005-9022CG	1	11	4' Wide Shelf	001-4442B	1

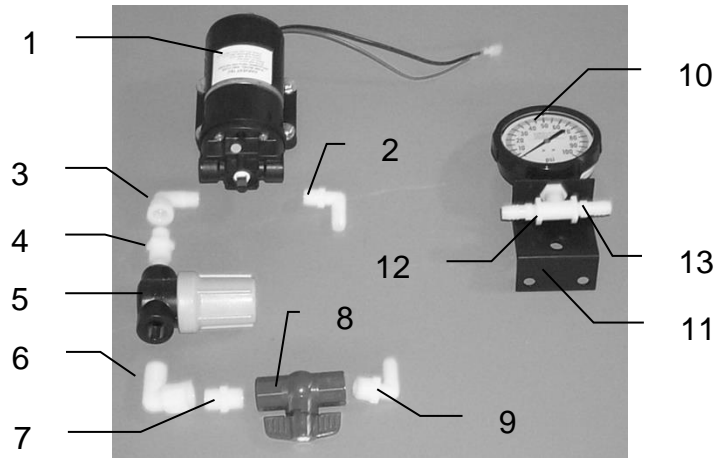

<u>Ref</u>	<u>Description</u>	<u>Part #</u>	<u>Qty</u>	<u>Ref</u>	<u>Description</u>	<u>Part #</u>	<u>Qty</u>
1	Pump	007-4120S	1	8	Ball valve	002-2212	1
2	Elbow fitting	003-EL3812	1	9	Elbow fitting	003-EL1212	1
3	Street elbow	003-SE38	1	10	Gauge	002-2208Z	1
4	Nipple fitting	003-M1238	1	11	Gauge bracket	001-4717	1
5	Filter bowl assembly	002-4315	1	12	Tee	003-TT14	1
6	Street elbow	003-SE12	1	13	Straight fitting	003-A1412	2
7	Nipple fitting	003-M1212	1				

Model 445Z Base Kit

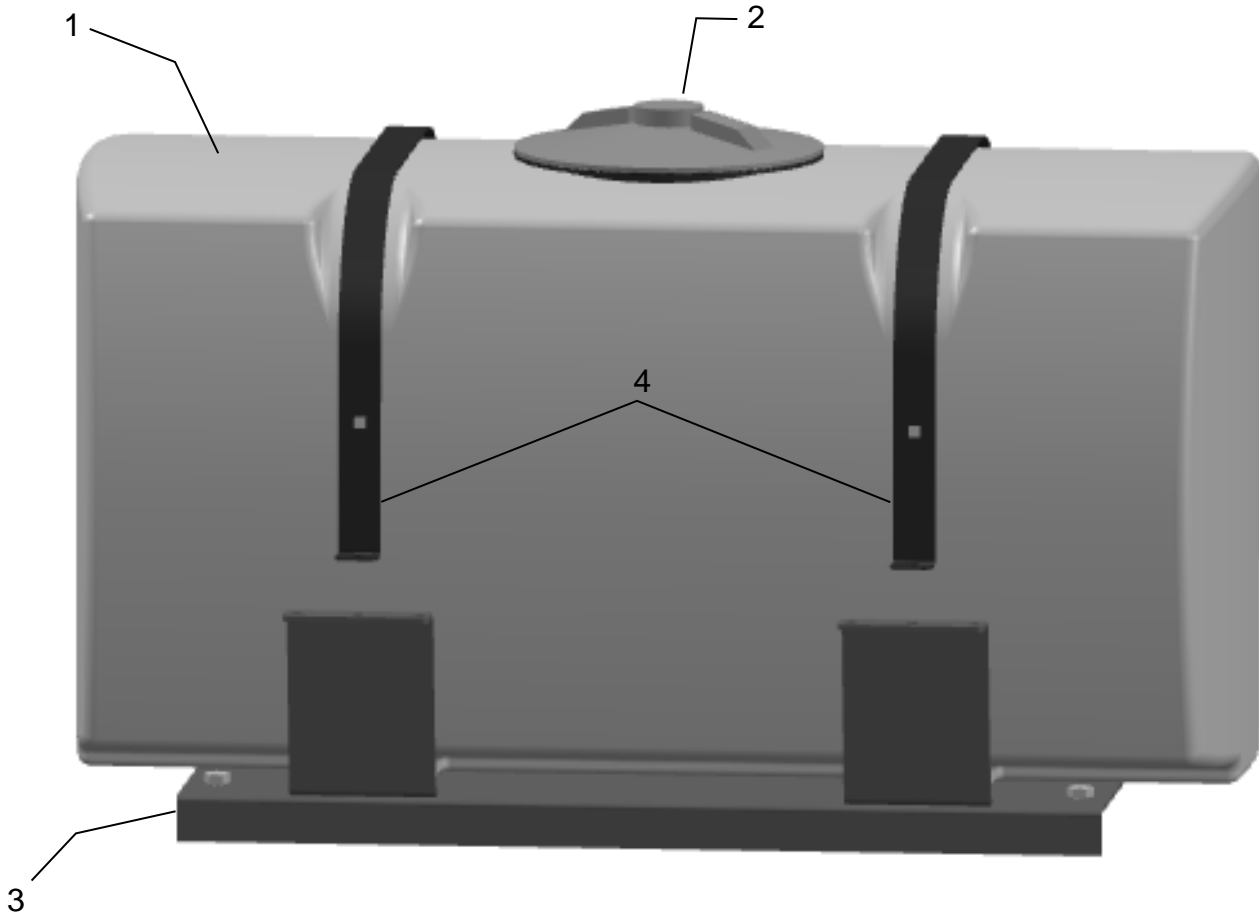

<u>Ref</u>	<u>Description</u>	<u>Part #</u>	<u>Qty</u>	<u>Ref</u>	<u>Description</u>	<u>Part #</u>	<u>Qty</u>
1	50 Gallon Tank	005-9203SQ	1	7	Side Rail Plate	001-4703ZR-E	4
2	Tank Cap, Gasket, & Breather	P05-9022HBG	1	8	Front Mount Support	001-4703ZR-D2	1
3	Tank Saddle	001-4703X	1	9	Front Mount Crossmember	001-4703ZR-D1	1
4	Tank Strap	001-4402	2	10	Long Side Rail	001-4703ZR-C	2
5	Tank Saddle Support	001-4703ZE-G	2	11	Mid Mount	001-4703ZR-B	1
6	Short Side Rail	001-4703ZR-F	2	12	Rear Mount	001-4703ZR-A	1
				NP	Hex Plug	003-F34	1
					Complete Kit	030-0445Z-TK	

Model 445Z Base Kit (continued)

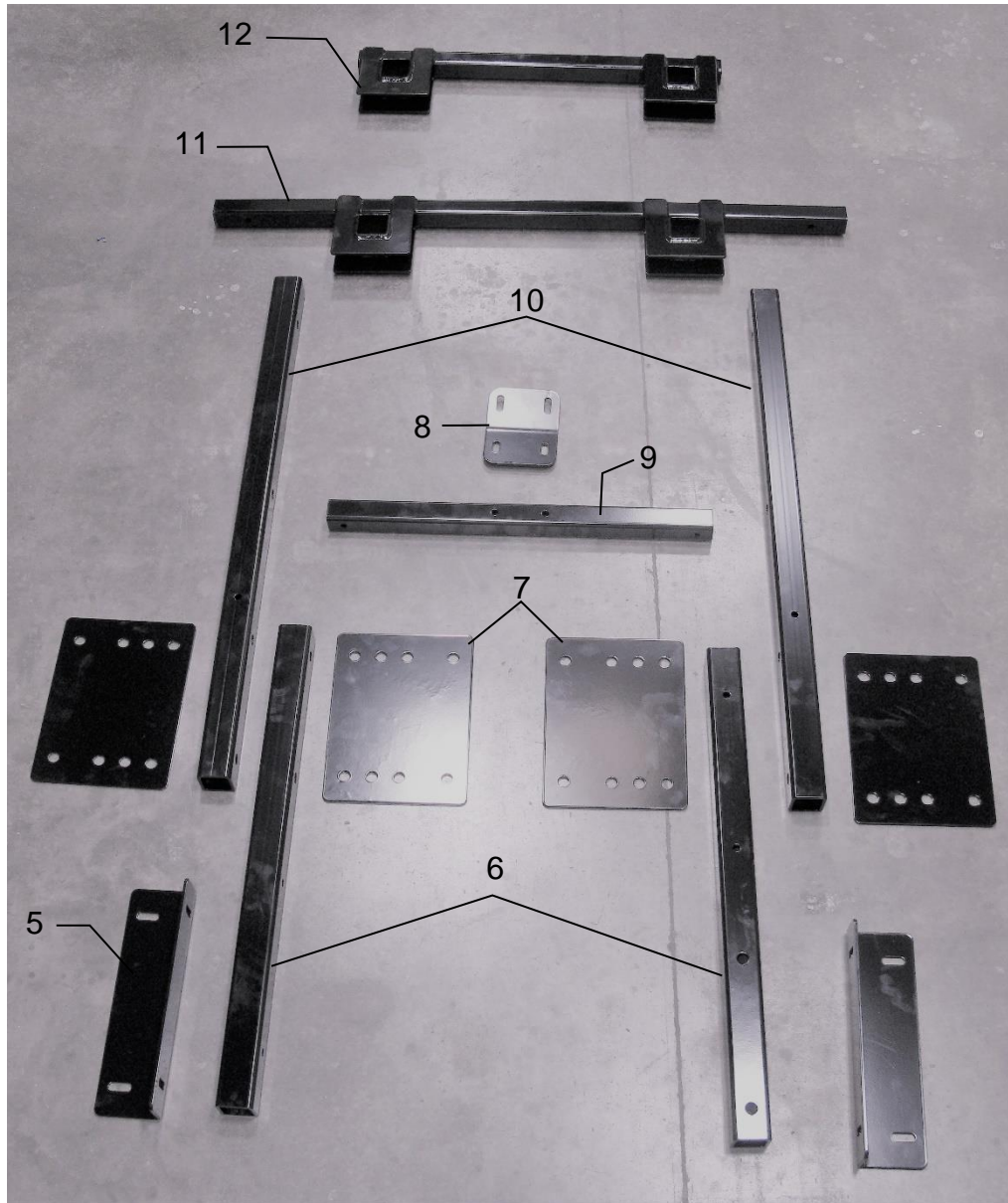

<u>Ref</u>	<u>Description</u>	<u>Part #</u>	<u>Qty</u>	<u>Ref</u>	<u>Description</u>	<u>Part #</u>	<u>Qty</u>
1	50 Gallon Tank	005-9203SQ	1	7	Side Rail Plate	001-4703ZR-E	4
2	Tank Cap, Gasket, & Breather	P05-9022HBG	1	8	Front Mount Support	001-4703ZR-D2	1
3	Tank Saddle	001-4703X	1	9	Front Mount Crossmember	001-4703ZR-D1	1
4	Tank Strap	001-4402	2	10	Long Side Rail	001-4703ZR-C	2
5	Tank Saddle Support	001-4703ZE-G	2	11	Mid Mount	001-4703ZR-B	1
6	Short Side Rail	001-4703ZR-F	2	12	Rear Mount	001-4703ZR-A	1
				NP	Hex Plug	003-F34	1
					Complete Kit	030-0445Z-TK	

Model 448 Base Kit

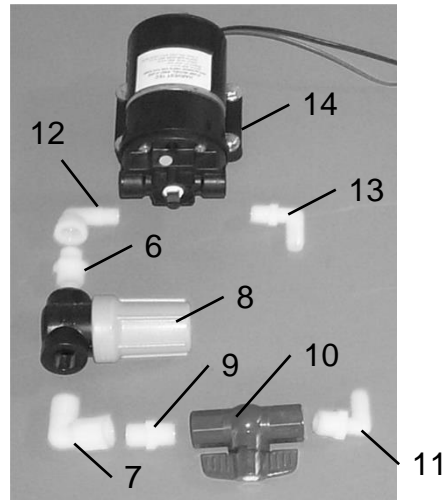
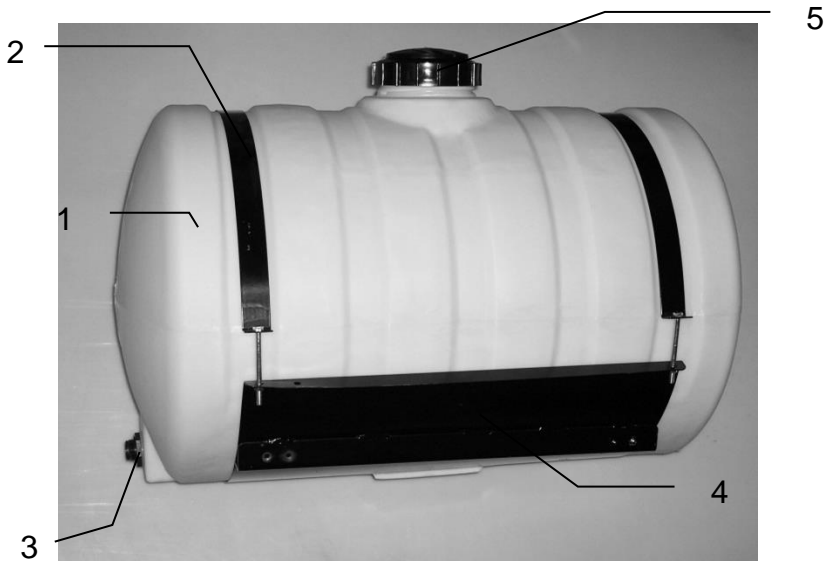

<u>Ref#</u>	<u>Description</u>	<u>Part #</u>	<u>Qty</u>	<u>Ref#</u>	<u>Description</u>	<u>Part #</u>	<u>Qty</u>
1	Tank	005-9203	1	8	Filter bowl	002-4315	1
2	Straps	001-4402	2	9	Nipple	003-M1212	1
3	Tank fitting	005-9100	2	10	Ball valve	002-2212	1
4	Saddle	001-4703	1	11	Elbow	003-EL1212	1
5	Tank cap	005-9022C	1	12	Elbow	003-SE38	1
5	Tank gasket	005-9022CG	1	13	Elbow	003-EL3812	1
6	Nipple	003-M1238	1	14	Pump	007-4120S	1
7	Elbow	003-SE12	2				

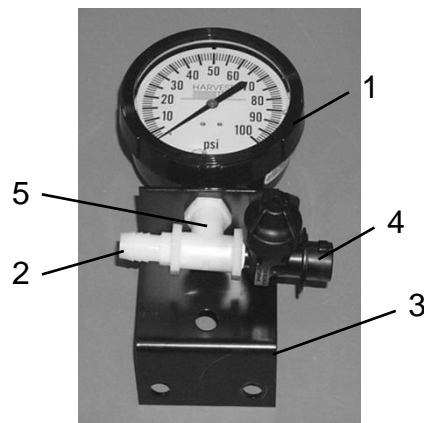

<u>Ref #</u>	<u>Description</u>	<u>Part #</u>	<u>Qty</u>	<u>Ref #</u>	<u>Description</u>	<u>Part #</u>	<u>Qty</u>
1	Gauge	002-2208Z	1	4	Check Valve	004-1207V	1
2	Straight Fitting	003-A1212	1	5	Tee	004-TT14	1
3	Gauge Bracket	001-4714	1				

Parts Breakdown for Control Box and Drain Fill Kit

Model 457 Control Box

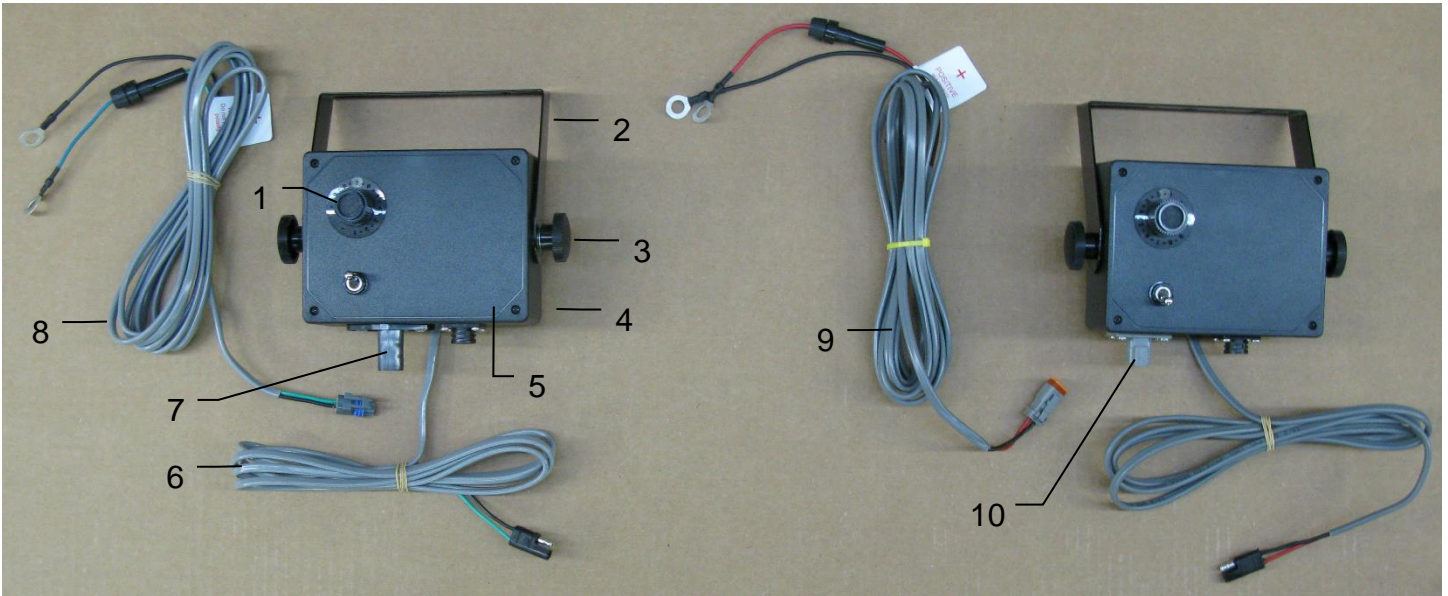

<u>Ref</u>	<u>Description</u>	<u>Part #</u>	<u>Qty</u>	<u>Ref</u>	<u>Description</u>	<u>Part #</u>	<u>Qty</u>
1	Speed dial	006-2022A	1	8	Power lead	006-4580C	1
2	U-bracket	001-2012E	1		Pre-Serial # 4549		
3	Control box knob	008-0923	2	9	Power lead	006-4580M	1
4	Control box enclosure	006-2015A	1		After Serial # 4550		
5	Control box cover	006-2015B	1	10	Box Plug	006-4581M	1
6	Pump lead	006-4583	1		After Serial # 4550		
7	Box Plug	006-4581					
	Pre-Serial # 4549						

Parts breakdown for drain fill (models 431, 434, 440, 442 & 448 only)

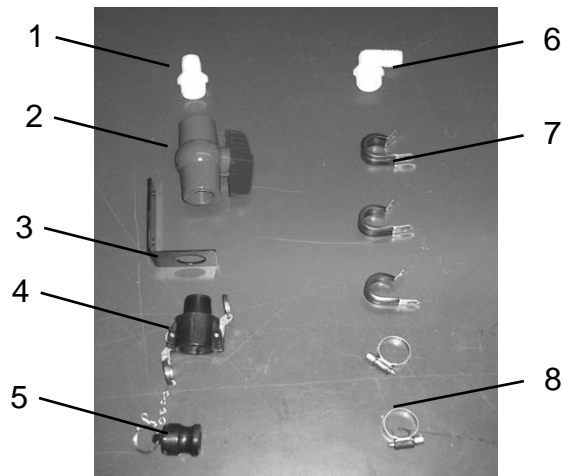

<u>Ref</u>	<u>Description</u>	<u>Part #</u>	<u>Qty</u>	<u>Ref</u>	<u>Description</u>	<u>Part #</u>	<u>Qty</u>
1	Straight fitting	003-A3434	1	5	Male coupler	002-2205G	1
2	Ball valve	002-2200	1	6	Elbow	003-EL3434	1
3	Valve holder	001-6702H	1	7	Jiffy clip	008-9010	1
4	Female coupler	002-2204A	1	8	Hose clamp	002-9004	2

Parts Breakdowns for Model Specific Installation Kits

Harvest Tec Model 442-SO Installation Kit

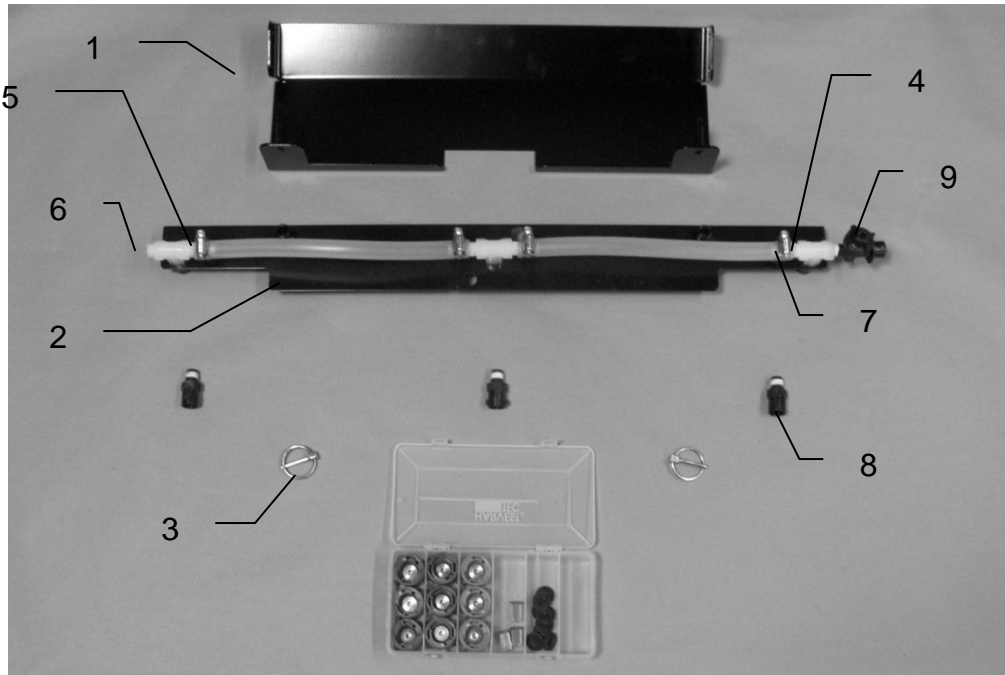

<u>Ref</u>	<u>Description</u>	<u>Part #</u>	<u>Qty</u>	<u>Description</u>	<u>Part #</u>	<u>Qty</u>
				Tip Kit complete	030-9002	1
1	Shield bracket	001-4810BRH	1	Tip Kit Includes:		
2	Spray shield	001-4810B	1	Plastic Box	008-9000	1
3	Lynch pin	008-4576	2	Red Cap	004-1207B	3
4	Tee	003-TT14	3	Outside Tip (Red Set)	004-650050-SS	2
5	Straight fitting	003-A1412	5	Inside Tip (Red Set)	004-XR11001VS	1
6	Plug	003-F14	1	Green Cap	004-1207A	3
7	Hose clamp	003-9003	5	Outside Tip (Green Set)	004-6501-SS	2
8	Male quick fitting	004-4710	3	Inside Tip (Green Set)	004-XR110015VS	1
9	Check valve	004-1207V	1	Blue Cap	004-1207C	3
				Outside Tip (Blue Set)	004-6502-SS	2
				Inside Tip (Blue Set)	004-XR11002VS	1
				Tip strainer	004-1203-100	3
				Washer	004-1207W	9

Harvest Tec Model 4400C Installation Kit

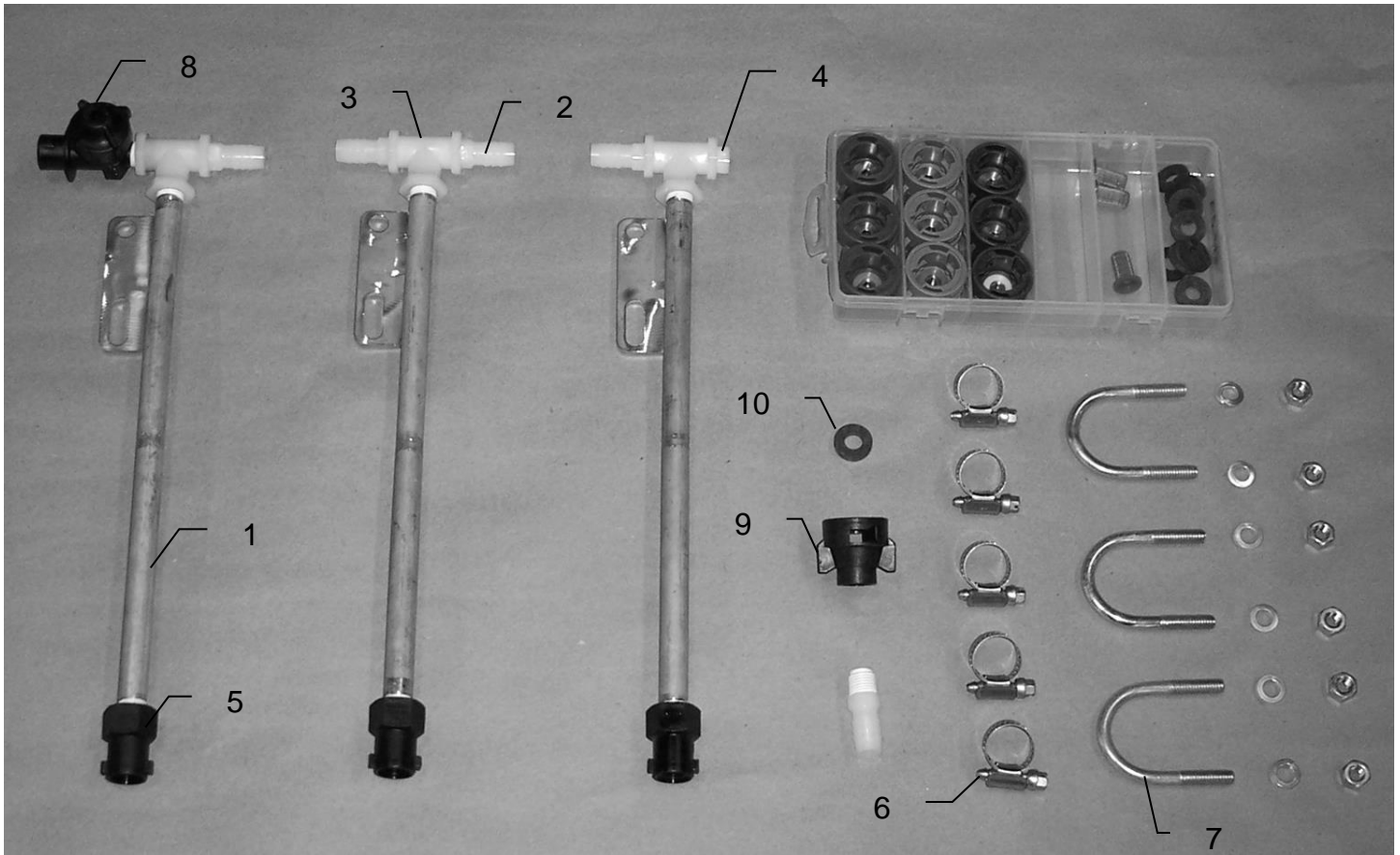

<u>Ref</u>	<u>Description</u>	<u>Part#</u>	<u>Qty</u>	<u>Description</u>	<u>Part#</u>	<u>Qty</u>
1	Nozzle tube	001-4714	3	Tip Kit (Complete)	030-9002	1
2	Straight fitting	003-A1412	5	Tip Kit Includes:		
3	Tee	003-TT14	3	Plastic Box	008-9000	1
4	Plug	003-F14	1	Red Cap	004-1207B	3
5	Nozzle Body	004-1207G	3	Outside Tip (Red Set)	004-650050-SS	2
6	Hose clamp	003-9003	5	Inside Tip (Red Set)	004-XR11001VS	1
7	U-Bolt	001-4714UBS	3	Green Cap	004-1207A	3
8	Check valve	004-1207V	1	Outside Tip (Green Set)	004-6501-SS	2
9	Female disconnect	004-1207H	1	Inside Tip (Green Set)	004-XR110015VS	1
10	Washer	004-1207W	1	Blue Cap	004-1207C	3
				Outside Tip (Blue Set)	004-6502-SS	2
				Inside Tip (Blue Set)	004-XR11002VS	1
				Washer	004-1207W	9
				Tip Strainer	004-1203-100	3

Harvest Tec Model 4409 Installation Kit

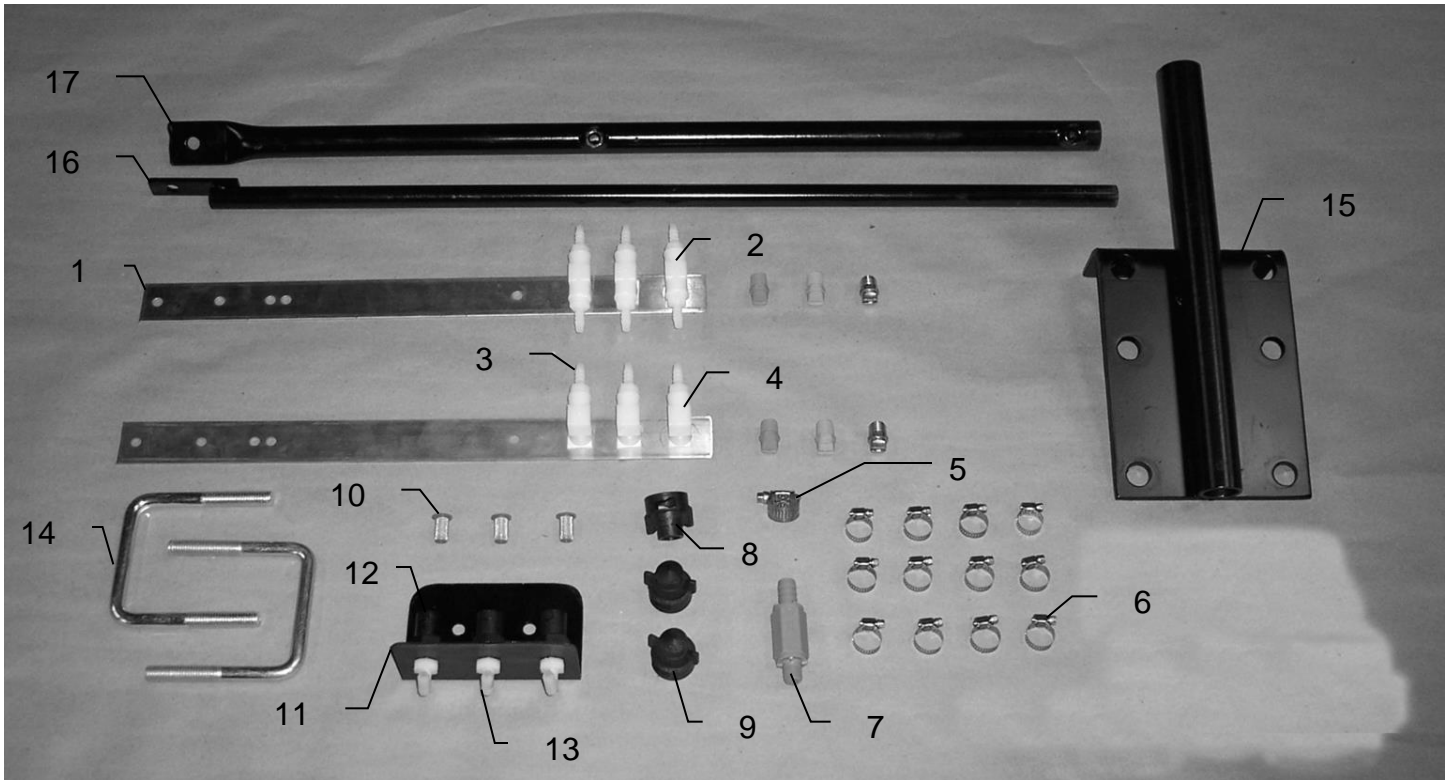

<u>Ref</u>	<u>Description</u>	<u>Part#</u>	<u>Qty</u>	<u>Description</u>	<u>Part#</u>	<u>Qty</u>
1	Nozzle strap	001-4215	2	Tip – Silver	004-T650050-SS	2
2	Tee	003-TT14SQ	3	Tip – Pink	004-T6501-PT	2
3	Straight fitting	003-A1414	9	Tip – Red	004-T6502-PT	2
4	Elbow	003-SE14F	3	Washer	004-1207W	3
5	Hose clamp	003-9003	1	Hose	002-9016	9 ft.
6	Hose clamp	003-9002	12			
7	Check valve	002-4564X	1			
8	Female disconnect	004-1207H	1			
9	Shutoff cap	004-1207F	2			
10	Tip screen	004-1203-200	3			
11	Hose manifold	001-4720	1			
12	Female coupler	004-1207G	3			
13	Elbow	003-EL1414	3			
14	U bolt	001-4406A	2			
15	Mounting manifold	001-4406	1			
16	Inside reach rod	001-4405	1			
17	Outside reach rod	001-4404	1			

Model 4410 Installation Kit

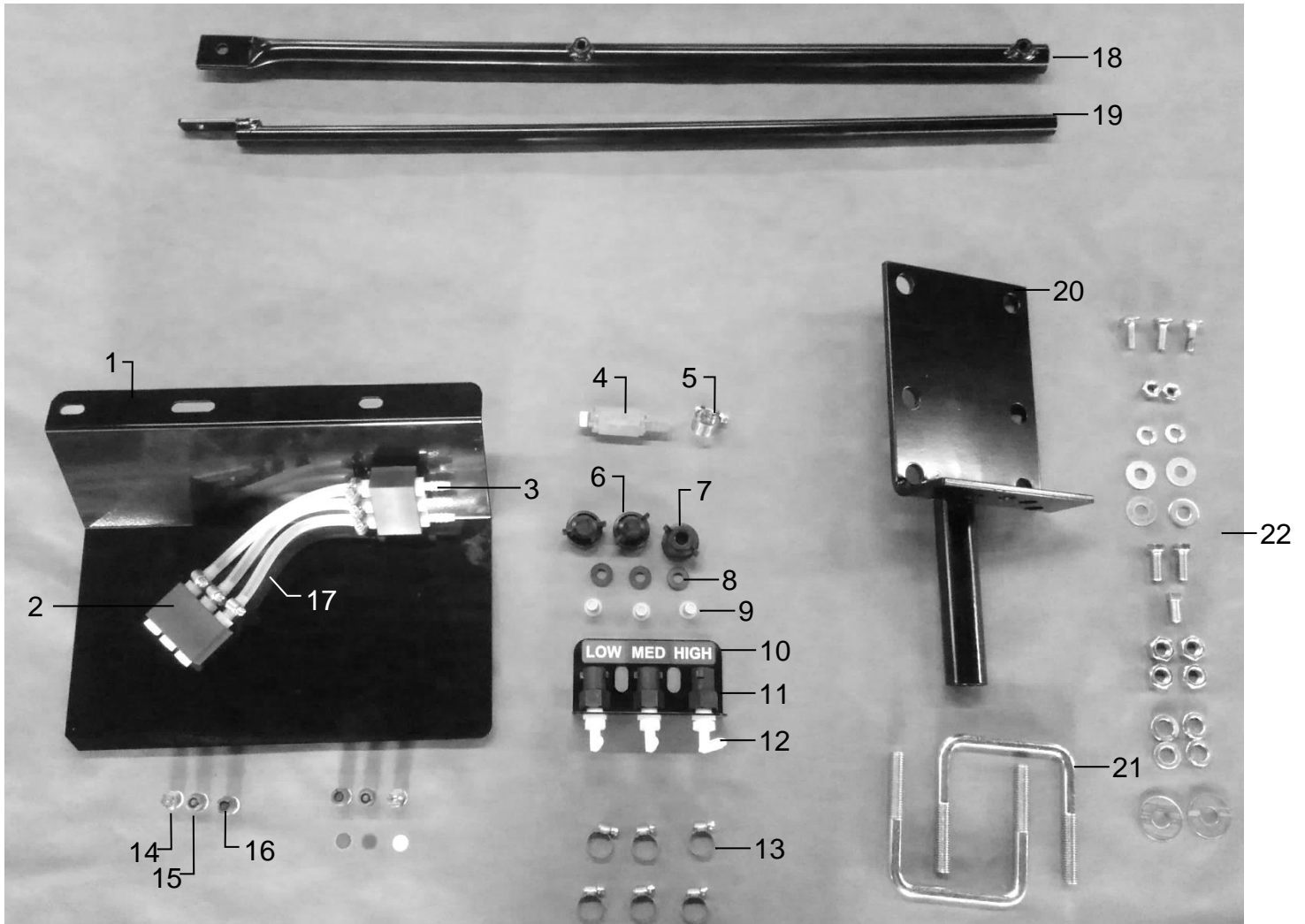

<u>Ref</u>	<u>Description</u>	<u>Part#</u>	<u>Qty</u>	<u>Description</u>	<u>Part#</u>	<u>Qty</u>	
1	Spray shield	001-4426A	1	13	Hose clamp	003-9002	12
2	Manifold Block	003-4435NSB	2	14	Tip – Silver	004-T650050-SS	2
3	Straight fitting	003-A1414	9	15	Tip – Pink / Grey	004-T6501-PT	2
4	Check valve	002-4564X	1	16	Tip – Red / Grey	004-T6502-PT	2
5	Hose clamp	003-9003	1	17	Hose	002-9016	9 ft.
6	Shutoff cap	004-1207F	2	18	Outside support rod	001-4404	1
7	Female discount	004-1207H	1	19	Inside support rod	001-4405	1
8	Washer	004-1207W	3	20	Mounting bracket	001-4406	1
9	Tip strainer	004-1203-200	3	21	U bolt	001-4406A	2
10	Hose manifold	001-4720	1	22	Mounting Hardware	Gen Hardware	
11	Female coupler	004-1207G	3				
12	Elbow	003-EL1414	3				
					Shield Only	030-4410-SO	
					(Ref 1-17)		

Harvest Tec Model 4415 Installation Kit

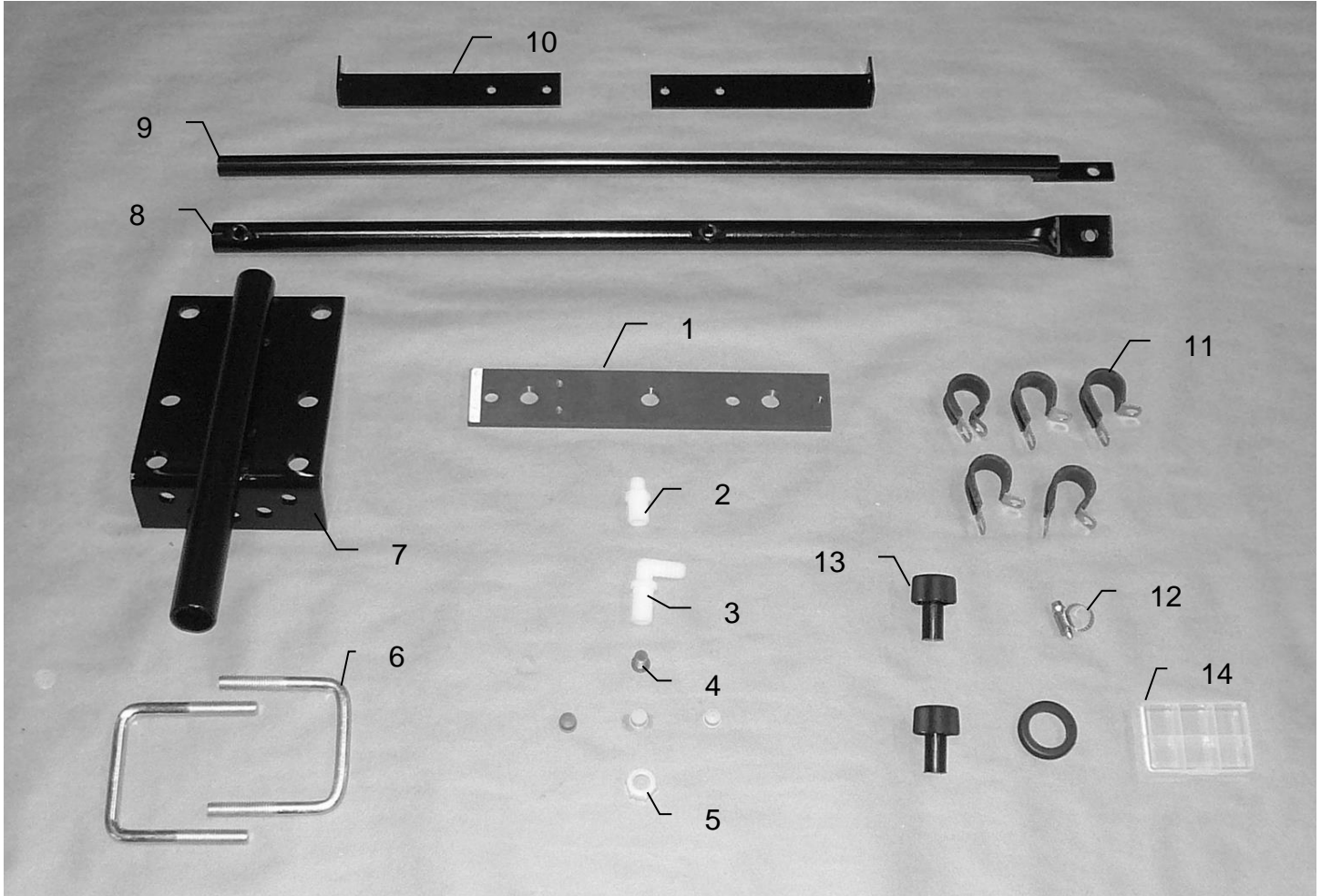

<u>Ref</u>	<u>Description</u>	<u>Part#</u>	<u>Qty</u>	<u>Description</u>	<u>Part#</u>	<u>Qty</u>
1	Spray shield	001-4425C	1	Tip – Orange	004-TX-SS-6	1
2	Drill guide	003-M3814NB	1	Tip – Blue	004-TX-SS-12	1
3	Elbow	003-EL3812NB	1	Tip - Yellow	004-TX-SS-26	1
4	Tip strainer	004-4213-100	1			
5	Nozzle cap	003-BC12	1			
6	U bolt	001-4406A	2			
7	Mounting bracket	001-4406	1			
8	Outside support rod	001-4404	1			
9	Inside support rod	001-4405	1			
10	Bracket	001-4425B	2			
11	Jiffy clip	008-9010	5			
12	Hose clamp	003-9003	1			
13	Knob	008-0925	2			
14	Tip box	008-9001	1			

Harvest Tec Model 4415-SO Installation Kit

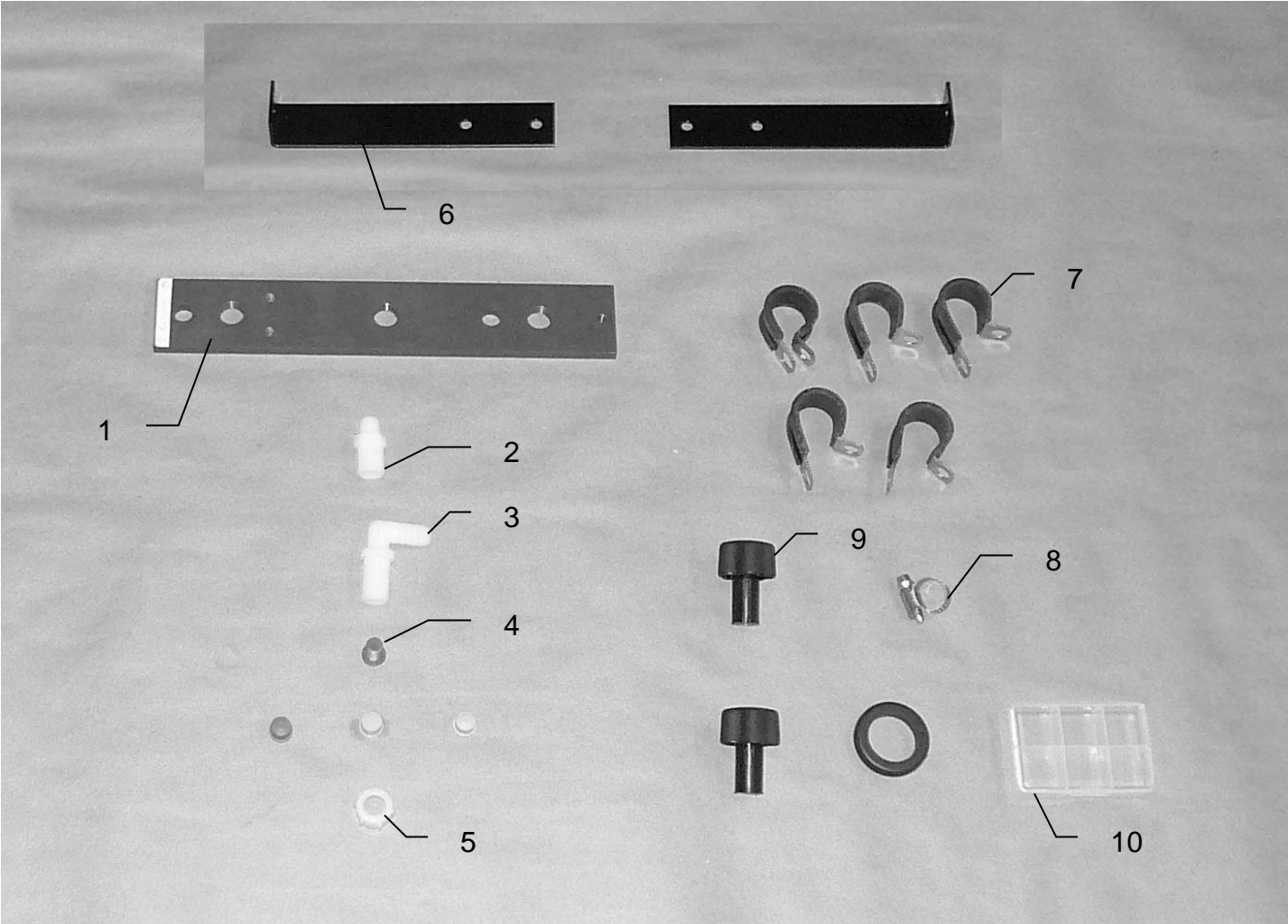

<u>Ref</u>	<u>Description</u>	<u>Part#</u>	<u>Qty</u>	<u>Description</u>	<u>Part#</u>	<u>Qty</u>
1	Spray shield	001-4425C	1	Tip – Orange	004-TX-SS-6	1
2	Drill guide	003-M3814NB	1	Tip – Blue	004-TX-SS-12	1
3	Elbow	003-EL3812NB	1	Tip – Yellow	004-TX-SS-26	1
4	Tip strainer	004-4213-100	1			
5	Nozzle cap	003-BC12	1			
6	Bracket	001-4425B	2			
7	Jiffy clip	008-9010	5			
8	Hose clamp	003-9003	1			
9	Knob	008-0925	2			
10	Tip box	009-9001	1			

Model 4416 Installation Kit

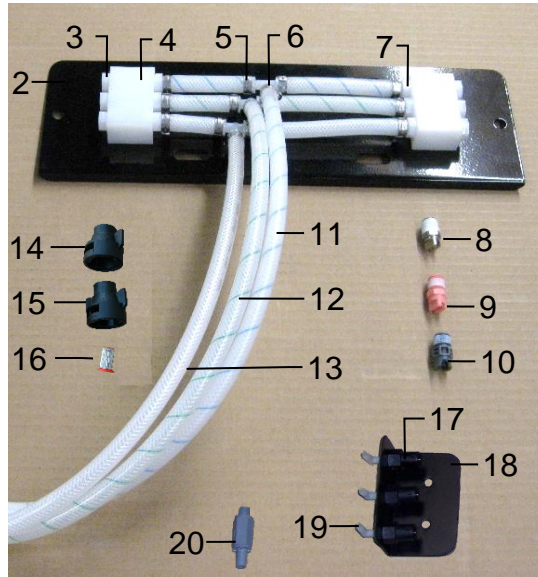
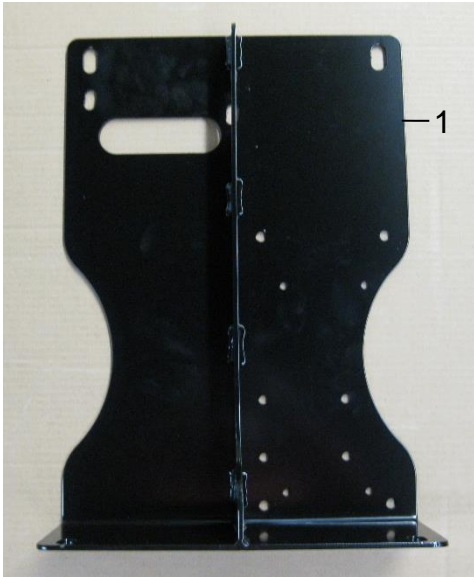

<u>Ref</u>	Description	Part #	<u>Qty</u>	<u>Ref</u>	Description	Part#	<u>Qty</u>
1	Saddle Legs	001-4703Q	2	14	1/4" Female Disconnect	004-1207H	1
2	Spray Shield	001-4424A2	1	15	Shut off cap	004-1207F	2
3	Plug	003-F14	6	16	Tip Strainer (200 mesh)	004-1203-200	3
4	Manifold Block	001-4435NSB	2	17	Female coupler	004-1207G	3
5	1/2" Oetiker Clamp	003-9008	15	18	Hose bracket	001-4720	1
6	1/4" Tee	003-T1414	3	19	Elbow	003-EL1414	6
7	1/4" Straight fitting	003-A1414	3	20	Check valve	002-4564X	1
8	Stainless Tip (small)	004-T650050-SS	2	21	Kicker Bracket	001-4703QC	1
9	Pink Tip (med)	004-T6501-PT	2	NP	Spray Shield Holders	001-4424B	2
10	Orange Tip (large)	004-T6502-PT	2	NP	Mini Hose Clamp	003-9002	3
11	1/4" Hose (green)	002-9016G	4	NP	Hose Clamp #6	003-9003	1
12	1/4" Hose (blue)	002-9016B	4				
13	1/4" Hose (clear)	002-9016	4				

Harvest Tec Model 4481 Installation Kit

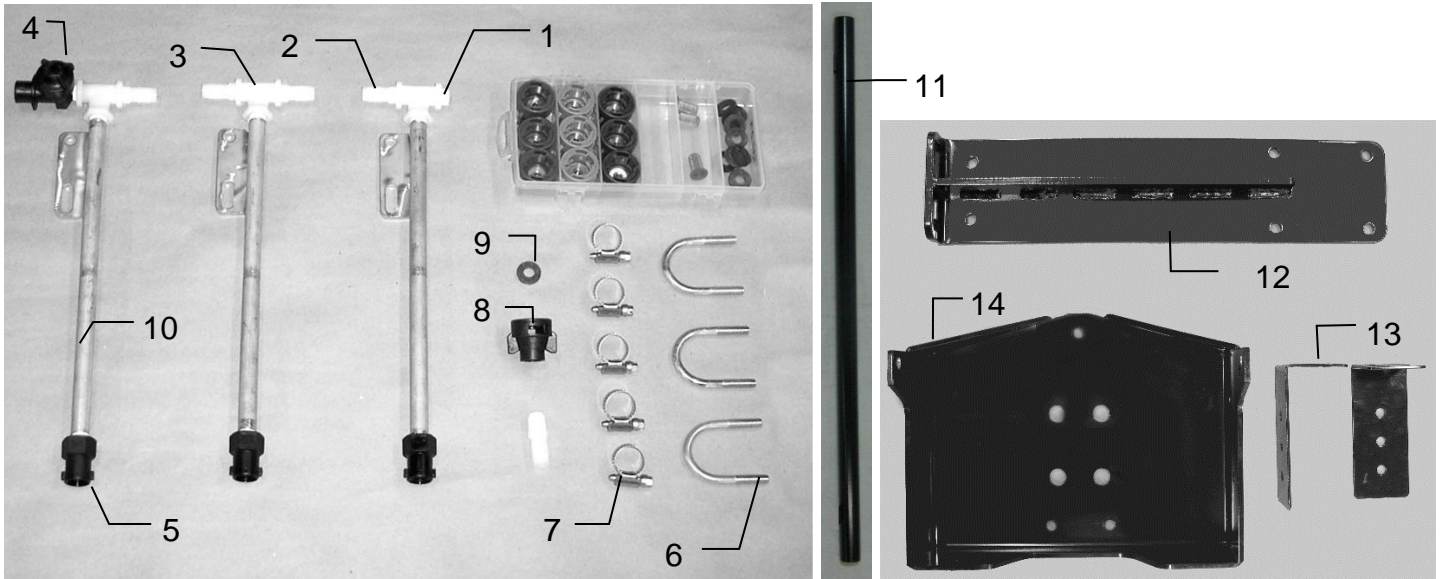

<u>Ref</u>	<u>Description</u>	<u>Part#</u>	<u>Qty</u>	<u>Description</u>	<u>Part#</u>	<u>Qty</u>
1	Plug	003-F14	1	Tip Kit (Complete)	030-9002	1
2	Straight fitting	003-A1412	5	Tip Kit Includes:		
3	Tee	003-TT14	3	Plastic Box	008-9000	1
4	Check valve	004-1207V	1	Red Cap	004-1207B	3
5	Female coupler	004-1207G	3	Outside Tip (Red Set)	004-650050-SS	2
6	U bolt	001-4714UBS	3	Inside Tip (Red Set)	004-XR11001VS	1
7	Hose clamp	003-9002	5	Green Cap	004-1207A	3
8	Female disconnect	004-1207H	1	Outside Tip (Green Set)	004-6501-SS	2
9	Washer	004-1207W	1	Inside Tip (Green Set)	004-XR110015VS	1
10	Nozzle tube	001-4714	3	Blue Cap	004-1207C	3
11	Nozzle holder	001-4703TP	1	Outside Tip (Blue Set)	004-6502-SS	2
12	Top Support	001-4704MK	1	Inside Tip (Blue Set)	004-XR11002VS	1
13	Pipe Holder	001-4703TH	2	Washer	004-1207W	9
14	Side Support	001-4704MAK	2	Tip Strainer	004-1203-100	3

Model 4482 Installation Kit

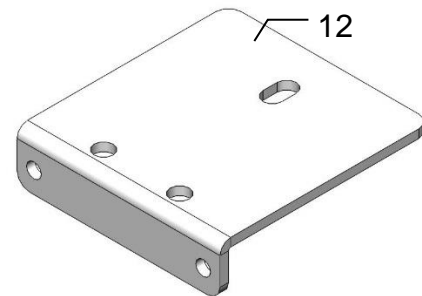
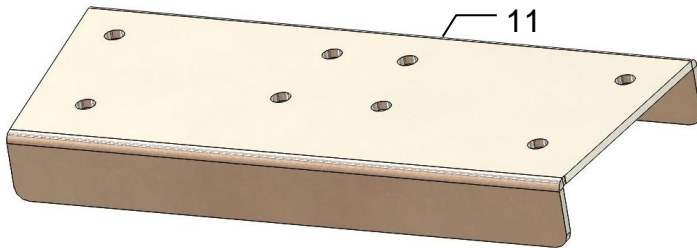
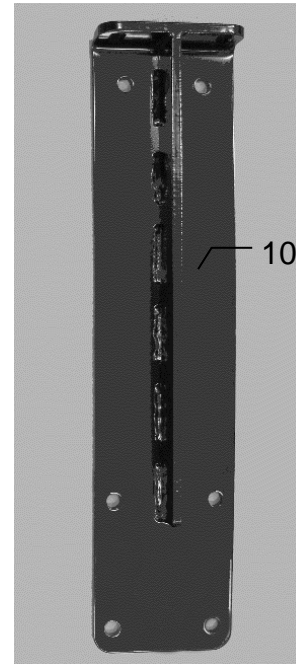
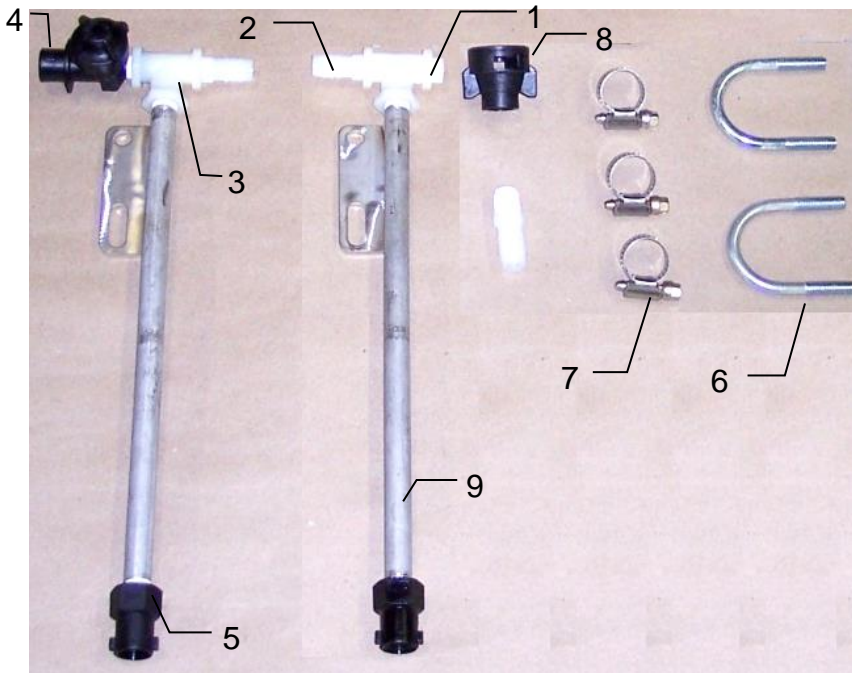

<u>Ref</u>	<u>Description</u>	<u>Part#</u>	<u>Qty</u>	<u>Ref</u>	<u>Description</u>	<u>Part#</u>	<u>Qty</u>
1	Plug	003-F14	1	NP	Red Cap	004-1207B	2
2	Straight fitting	003-A1412	3		Tip – Orange	004-XR11001VS	2
3	Tee	003-TT14	2		Green Cap	004-1207A	2
4	Check valve	004-1207V	1		Tip - Blue	004-XR11003VS	2
5	Female coupler	004-1207G	2		Blue Cap	004-1207C	2
6	U bolt	001-4714UBS	2		Tip-Yellow	004-XR11002VS	2
7	Hose clamp	003-9003	3		Tip Strainer	004-1203-100	2
8	Female disconnect	004-1207H	1				
9	Nozzle tube	001-4714	2				
10	Side Support Leg	001-4704MAK	2				
11	Top Tank Support	001-4704MRF	1				
12	Front Mounting Plate	001-4703VZ	1				

Harvest Tec Model 4483 Installation Kit

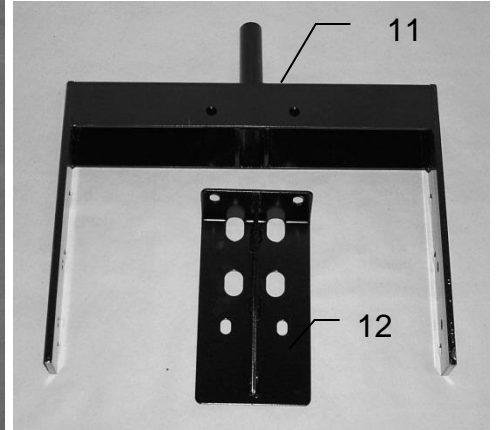
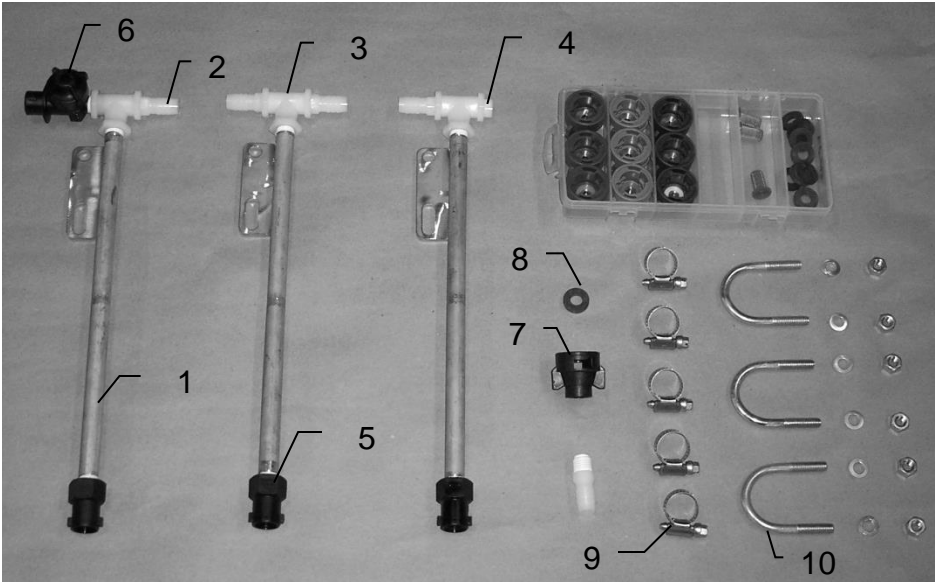

<u>Ref</u>	Description	Part #	<u>Qty</u>	Description	Part#	<u>Qty</u>
1	Nozzle tube	001-4714	3	Tip Kit (Complete)	030-9002	1
2	Straight fitting	003-A1412	5	Tip Kit Includes:		
3	Tee	003-TT14	3	Plastic Box	008-9000	1
4	Plug	003-F14	1	Red Cap	004-1207B	3
5	Nozzle Body	004-1207G	3	Outside Tip (Red Set)	004-650050-SS	2
6	Check valve	004-1207V	1	Inside Tip (Red Set)	004-XR11001VS	1
7	Female disconnect	004-1207H	1	Green Cap	004-1207A	3
8	Washer	004-1207W	1	Outside Tip (Green Set)	004-6501-SS	2
9	Hose clamp	003-9003	5	Inside Tip (Green Set)	004-XR110015VS	1
10	U-Bolt	001-4714UBS	3	Blue Cap	004-1207C	3
11	Mounting brkt	001-4411	1	Outside Tip (Blue Set)	004-6502-SS	2
12	Support bracket	001-4411A	1	Inside Tip (Blue Set)	004-XR11002VS	1
				Washer	004-1207W	9
				Tip Strainer	004-1203-100	3

Harvest Tec Model 4484 Installation Kit

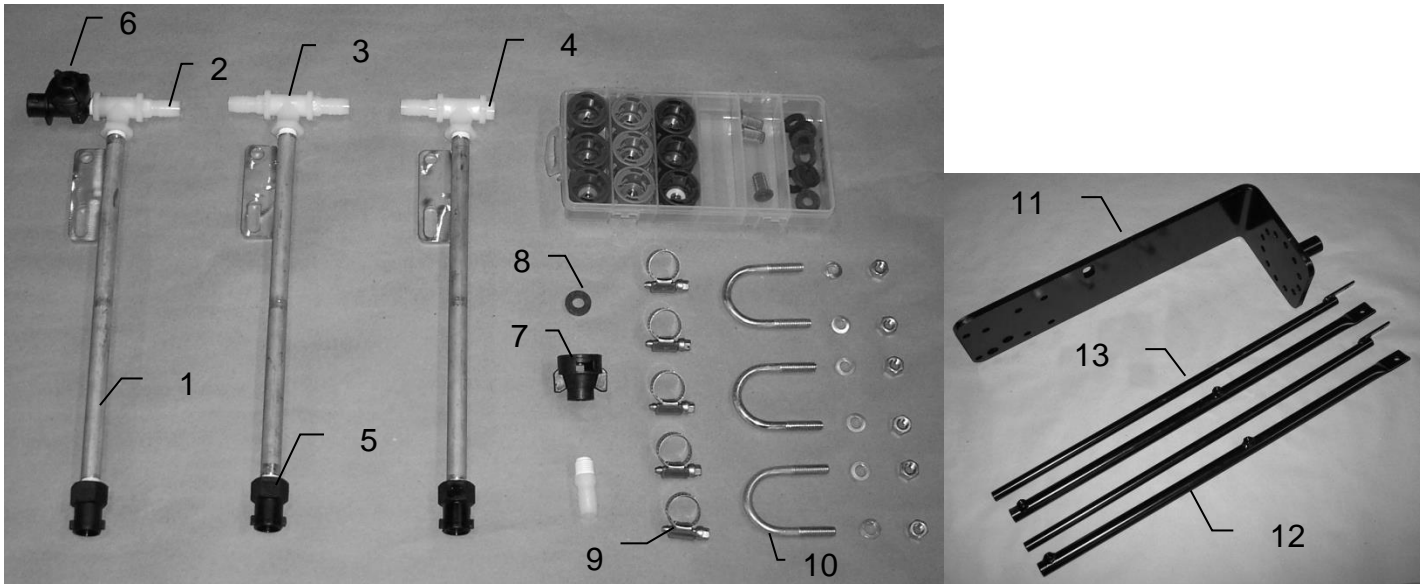

<u>Ref</u>	Description	Part #	<u>Qty</u>	Description	Part#	<u>Qty</u>
1	Nozzle tube	001-4714	3	Tip Kit (Complete)	030-9002	1
2	Straight fitting	003-A1412	5	Tip Kit Includes:		
3	Tee	003-TT14	3	Plastic Box	008-9000	1
4	Plug	003-F14	1	Red Cap	004-1207B	3
5	Nozzle Body	004-1207G	3	Outside Tip (Red Set)	004-650050-SS	2
6	Check valve	004-1207V	1	Inside Tip (Red Set)	004-XR11001VS	1
7	Female disconnect	004-1207H	1	Green Cap	004-1207A	3
8	Washer	004-1207W	1	Outside Tip (Green Set)	004-6501-SS	2
9	Hose clamp	003-9003	5	Inside Tip (Green Set)	004-XR110015VS	1
10	U-Bolt	001-4714UBS	3	Blue Cap	004-1207C	3
11	Mounting bracket	001-4418	1	Outside Tip (Blue Set)	004-6502-SS	2
12	Outside support rod	001-4404	2	Inside Tip (Blue Set)	004-XR11002VS	1
13	Inside support rod	001-4405	2	Washer	004-1207W	9
				Tip Strainer	004-1203-100	3

Harvest Tec Model 4485 Installation Kit

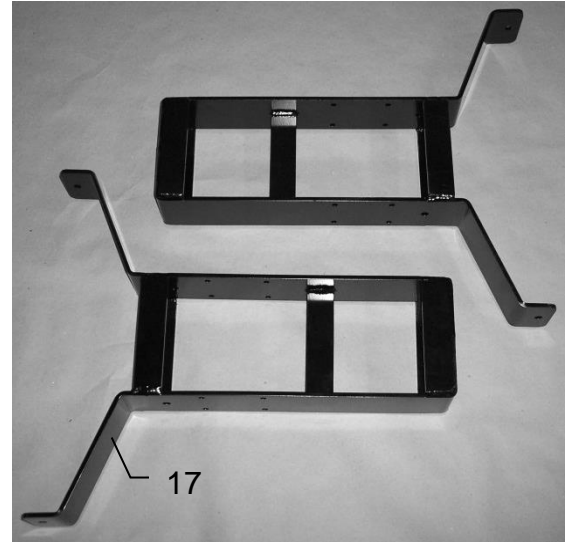
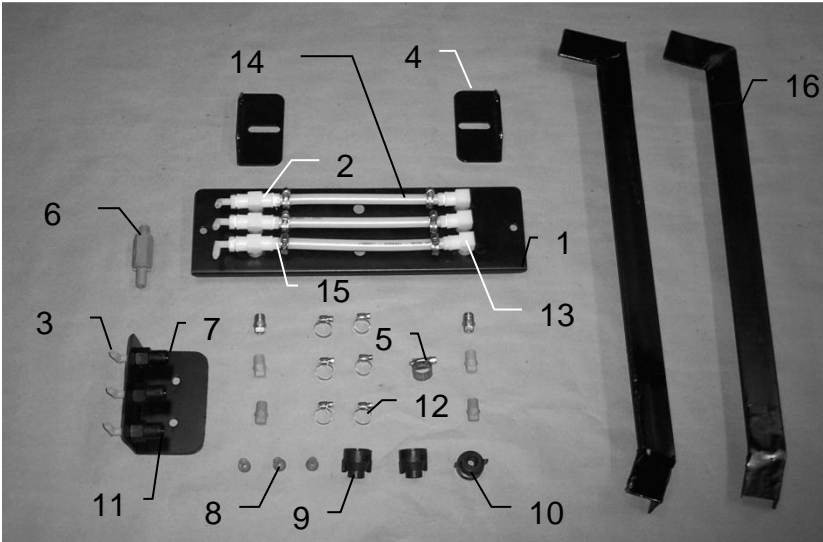

<u>Ref</u>	<u>Description</u>	<u>Part#</u>	<u>Qty</u>	<u>Ref</u>	<u>Description</u>	<u>Part#</u>	<u>Qty</u>
1	Spray shield	001-4424A	1	NP	Tip – Silver	004-T650050-SS	2
2	Tee	003-TT14SQ	3	NP	Tip – Pink	004-T6501-PT	2
3	Elbow	003-EL1414	6	NP	Tip – Red	004-T6502-PT	2
4	Shield holder	001-4424B	2	NP	Washer	004-1207W	3
5	Hose clamp	003-9003	1	NP	Not pictured		
6	Check valve	002-4564X	1				
7	Hose bracket	001-4720	1				
8	Tip strainer	004-1203-200	3				
9	Shutoff cap	004-1207F	2				
10	Female discount	004-1207H	1				
11	Female coupler	004-1207G	3				
12	Hose clamp	003-9002	12				
13	Elbow	003-SE14F	3				
14	Hose	002-9016	9 ft				
15	Straight fitting	003-A1414	3				
16	Leg supports	001-4424C	2				
17	Saddle leg	001-4703B	2				

Harvest Tec Model 4486 Installation Kit

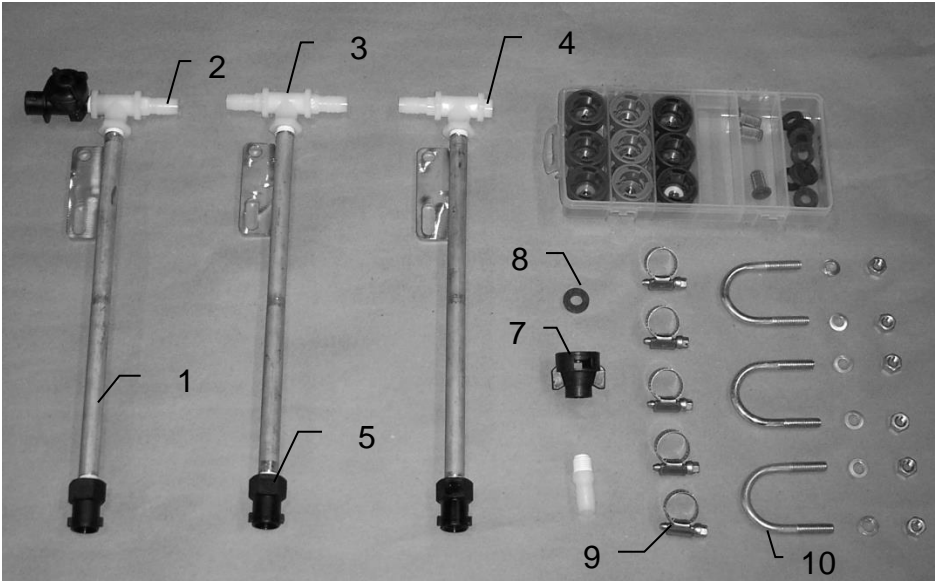

<u>Ref</u>	<u>Description</u>	<u>Part #</u>	<u>Qty</u>	<u>Description</u>	<u>Part #</u>	<u>Qty</u>
1	Nozzle tube	001-4714	3	Tip Kit (Complete)	030-9002	1
2	Straight fitting	003-A1412	5	Tip Kit Includes:		
3	Tee	003-TT14	3	Plastic Box	008-9000	1
4	Plug	003-F14	1	Red Cap	004-1207B	3
5	Nozzle Body	004-1207G	3	Outside Tip (Red Set)	004-650050-SS	2
6	Check valve	004-1207V	1	Inside Tip (Red Set)	004-XR11001VS	1
7	Female disconnect	004-1207H	1	Green Cap	004-1207A	3
8	Washer	004-1207W	1	Outside Tip (Green Set)	004-6501-SS	2
9	Hose clamp	003-9003	5	Inside Tip (Green Set)	004-XR110015VS	1
10	U-Bolt	001-4714UBS	3	Blue Cap	004-1207C	3
11	Mounting bracket	001-4420	1	Outside Tip (Blue Set)	004-6502-SS	2
12	Outside support rod	001-4404A	2	Inside Tip (Blue Set)	004-XR11002VS	1
13	Inside support rod	001-4405A	2	Washer	004-1207W	9
				Tip Strainer	004-1203-100	3

Harvest Tec Model 4502 Installation Kit

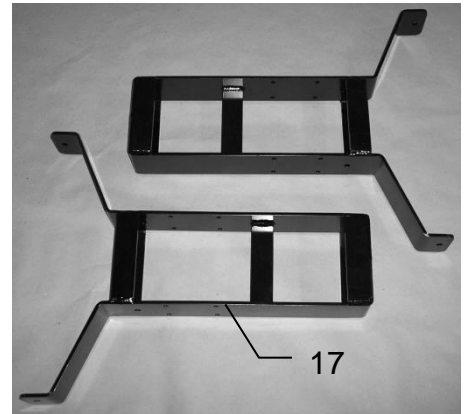
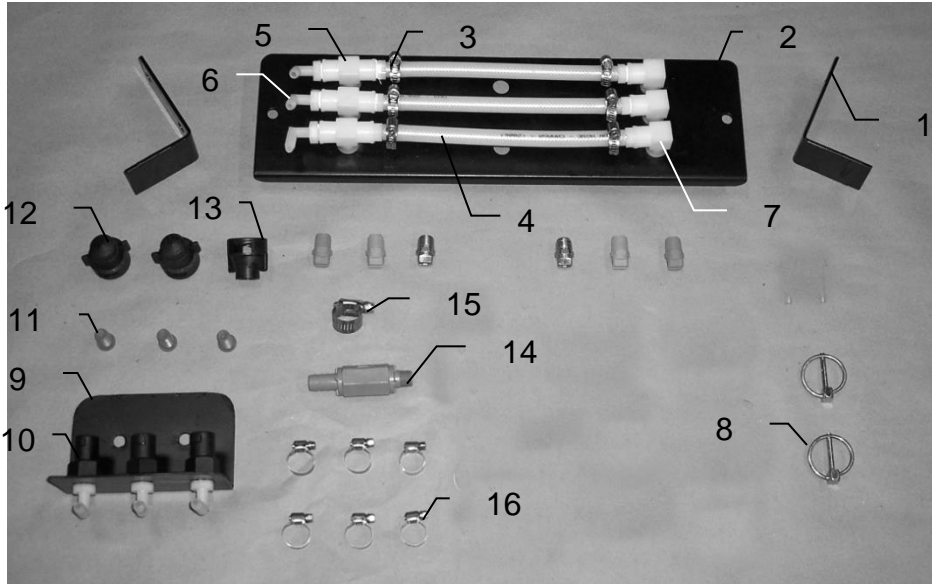

<u>Ref</u>	<u>Description</u>	<u>Part#</u>	<u>Qty</u>	<u>Ref</u>	<u>Description</u>	<u>Part#</u>	<u>Qty</u>
1	Shield holder	001-4703I	2	NP	Tip – Silver	004-T650050-SS	2
2	Spray shield	001-4703G	1	NP	Tip – Pink	004-T6501-PT	2
3	Straight fitting	003-A1414	6	NP	Tip – Red	004-T6502-PT	2
4	Hose	002-9016	9 ft	NP	Washer	004-1207W	3
5	Tee	003-TT14SQ	3	NP	Not pictured		
6	Elbow	003-EL1414	6				
7	Elbow	003-SE14F	3				
8	Lynch pin	008-4576	2				
9	Hose bracket	001-4720	1				
10	Female coupler	004-1207G	3				
11	Tip strainer	004-1203-200	3				
12	Shutoff cap	004-1207F	2				
13	Female disconnect	004-1207H	1				
14	Check valve	002-4564X	1				
15	Hose clamp	002-9003	1				
16	Hose clamp	003-9002	12				
17	Saddle leg	001-4703B	2				

Harvest Tec Model 4503 Installation Kit

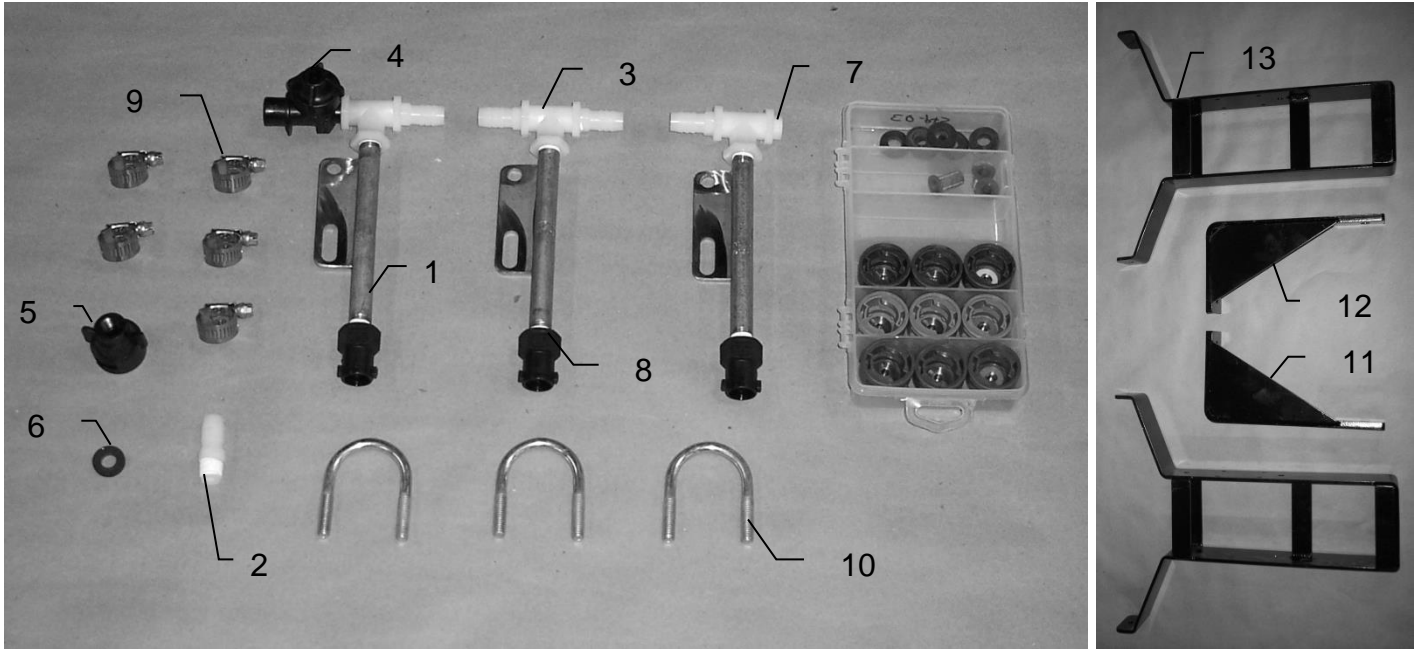

<u>Ref</u>	<u>Description</u>	<u>Part #</u>	<u>Qty</u>	<u>Description</u>	<u>Part#</u>	<u>Qty</u>
1	Nozzle tube	001-4714P	3	Tip Kit (Complete)	030-9002	1
2	Straight fitting	003-A1412	5	Tip Kit Includes:		
3	Tee	003-TT14	3	Plastic Box	008-9000	1
4	Check valve	004-1207V	1	Red Cap	004-1207B	3
5	Female disconnect	004-1207H	1	Outside Tip (Red Set)	004-650050-SS	2
6	Washer	004-1207W	1	Inside Tip (Red Set)	004-XR11001VS	1
7	Plug	003-F14	1	Green Cap	004-1207A	3
8	Nozzle Body	004-1207G	3	Outside Tip (Green Set)	004-6501-SS	2
9	Hose clamp	003-9003	5	Inside Tip (Green Set)	004-XR110015VS	1
10	U-Bolt	001-4714UBS	3	Blue Cap	004-1207C	3
11	Left mtg bracket	001-4703EL	1	Outside Tip (Blue Set)	004-6502-SS	2
12	Right mtg bracket	001-4703ER	1	Inside Tip (Blue Set)	004-XR11002VS	1
13	Saddle leg	001-4703B	2	Washer	004-1207W	9
NP	45 degree elbows	003-SE4514	3	Tip Strainer	004-1203-100	3
NP	Jack extension	001-4703EXT	1			

Harvest Tec Model 4504 Installation Kit

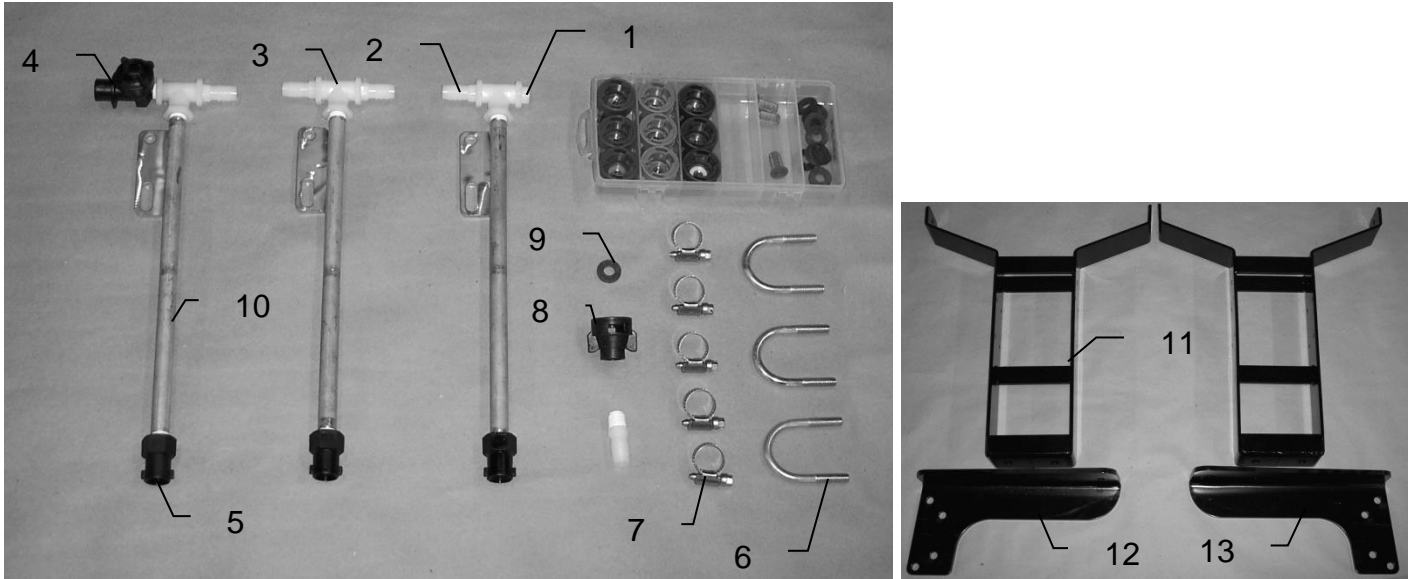

<u>Ref</u>	<u>Description</u>	<u>Part#</u>	<u>Qty</u>	<u>Description</u>	<u>Part#</u>	<u>Qty</u>
1	Plug	003-F14	1	Tip Kit (Complete)	030-9002	1
2	Straight fitting	003-A1412	5	Tip Kit Includes:		
3	Tee	003-TT14	3	Plastic Box	008-9000	1
4	Check valve	004-1207V	1	Red Cap	004-1207B	3
5	Female coupler	004-1207G	3	Outside Tip (Red Set)	004-650050-SS	2
6	U bolt	001-4714UBS	3	Inside Tip (Red Set)	004-XR11001VS	1
7	Hose clamp	003-9002	5	Green Cap	004-1207A	3
8	Female disconnect	004-1207H	1	Outside Tip (Green Set)	004-6501-SS	2
9	Washer	004-1207W	1	Inside Tip (Green Set)	004-XR110015VS	1
10	Nozzle tube	001-4714	3	Blue Cap	004-1207C	3
11	Saddle leg	001-4703B	2	Outside Tip (Blue Set)	004-6502-SS	2
12	Left mtg bracket	001-4703DL	1	Inside Tip (Blue Set)	004-XR11002VS	1
13	Right mtg bracket	001-4703DR	1	Washer	004-1207W	9
				Tip Strainer	004-1203-100	3

Harvest Tec Model 4505 Installation Kit

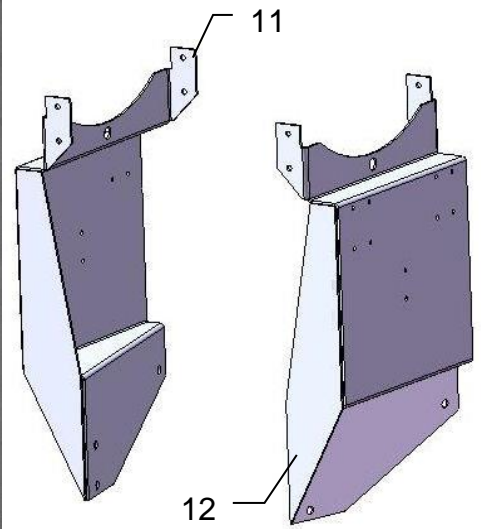
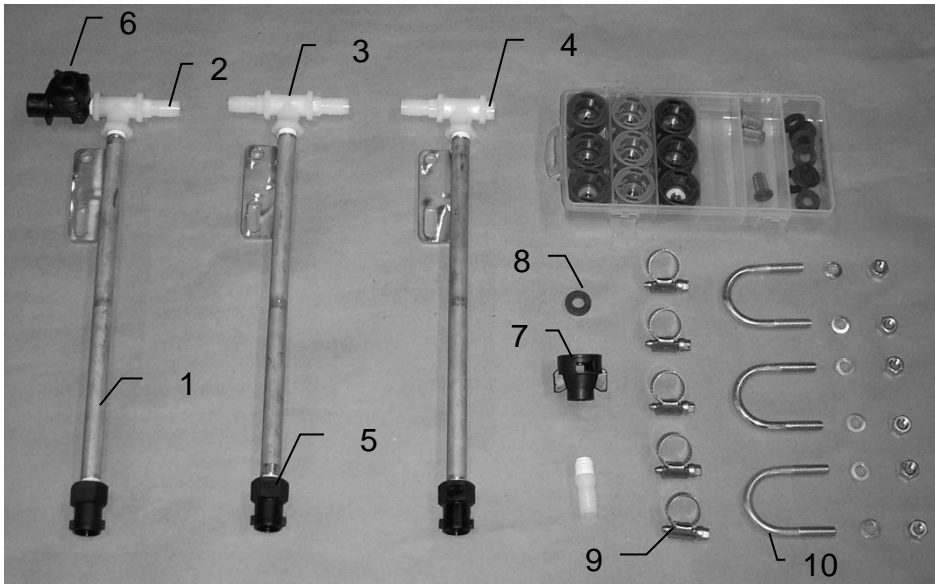

<u>Ref</u>	<u>Description</u>	<u>Part #</u>	<u>Qty</u>	<u>Description</u>	<u>Part#</u>	<u>Qty</u>
1	Nozzle tube	001-4714	3	Tip Kit (Complete)	030-9002	1
2	Straight fitting	003-A1412	5	Tip Kit Includes:		
3	Tee	003-TT14	3	Plastic Box	008-9000	1
4	Plug	003-F14	1	Red Cap	004-1207B	3
5	Nozzle Body	004-1207G	3	Outside Tip (Red Set)	004-650050-SS	2
6	Check valve	004-1207V	1	Inside Tip (Red Set)	004-XR11001VS	1
7	Female disconnect	004-1207H	1	Green Cap	004-1207A	3
8	Washer	004-1207W	1	Outside Tip (Green Set)	004-6501-SS	2
9	Hose clamp	003-9003	5	Inside Tip (Green Set)	004-XR110015VS	1
10	U-Bolt	001-4714UBS	3	Blue Cap	004-1207C	3
11	Left Leg	001-4703FL	1	Outside Tip (Blue Set)	004-6502-SS	2
12	Right Leg	001-4703FR	1	Inside Tip (Blue Set)	004-XR11002VS	1
				Washer	004-1207W	9
				Tip Strainer	004-1203-100	3

Harvest Tec Model 4506 Installation Kit

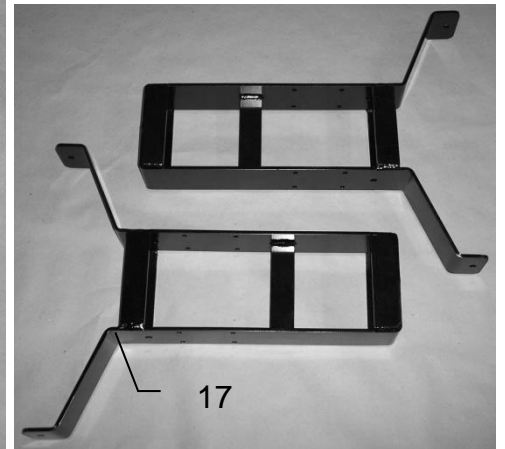
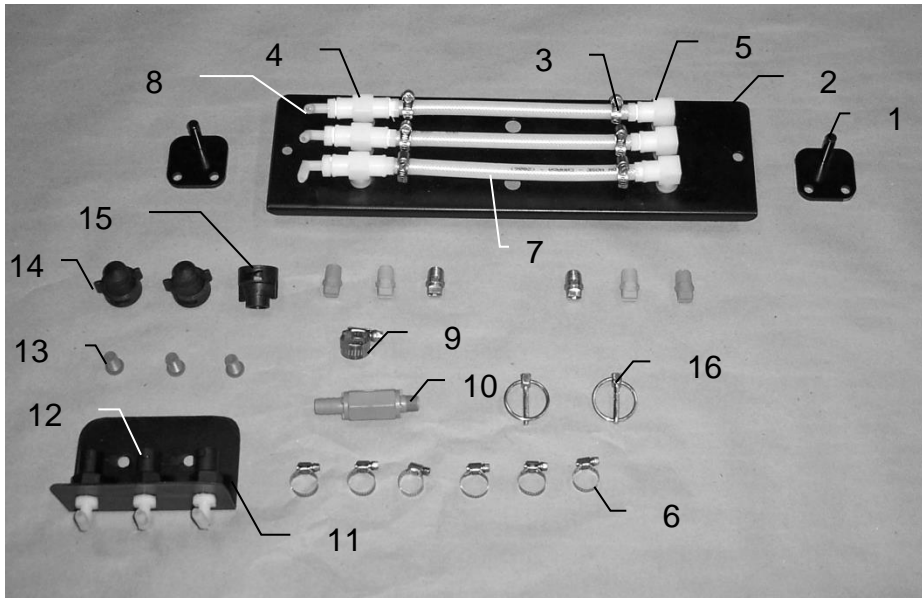

<u>Ref</u>	<u>Description</u>	<u>Part#</u>	<u>Qty</u>	<u>Ref</u>	<u>Description</u>	<u>Part#</u>	<u>Qty</u>
1	Shield holder	001-4703H	2	NP	Tip – Silver	004-T650050-SS	2
2	Spray shield	001-4703G	1	NP	Tip – Pink	004-T6501-PT	2
3	Straight fitting	003-A1414	6	NP	Tip – Red	004-T6502-PT	2
4	Tee	003-TT14SQ	3	NP	Washer	004-1207W	3
5	Elbow	003-SE14F	3	NP	Not pictured		
6	Hose clamp	003-9002	12				
7	Hose	002-9016	6				
8	Elbow	003-EL1414	6				
9	Hose clamp	003-9003	1				
10	Check valve	002-4564X	1				
11	Hose bracket	001-4720	1				
12	Female coupler	004-1207G	3				
13	Tip strainer	004-1203-200	3				
14	Shutoff cap	004-1207F	2				
15	Female disconnect	004-1207H	1				
16	Lynch pin	008-4576	2				
17	Saddle leg	001-4703B	2				

Harvest Tec Model 4507 Installation Kit

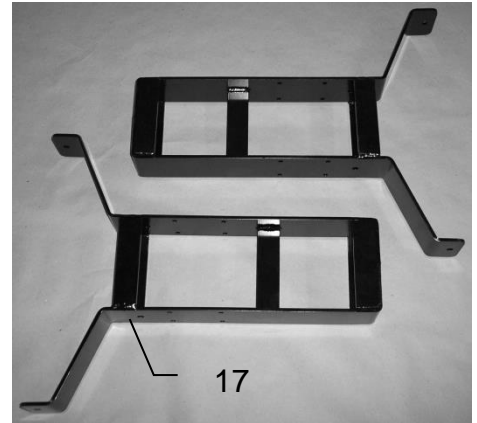
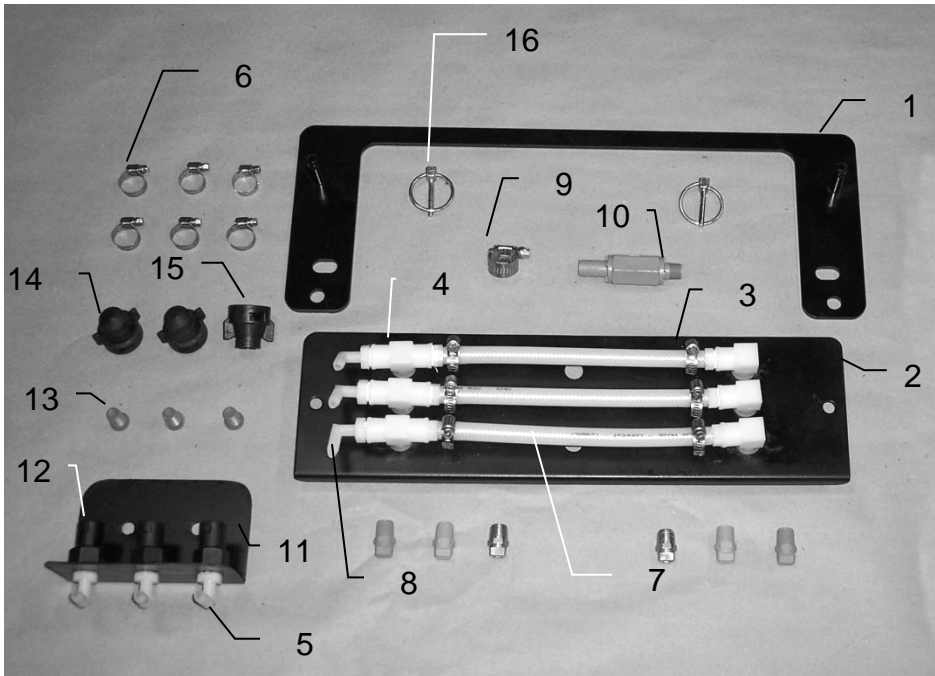

<u>Ref</u>	<u>Description</u>	<u>Part#</u>	<u>Qty</u>	<u>Ref</u>	<u>Description</u>	<u>Part#</u>	<u>Qty</u>
1	Shield holder	001-4703J	1	NP	Tip – Silver	004-T650050-SS	2
2	Spray shield	001-4703G	1	NP	Tip – Pink	004-T6501-PT	2
3	Straight fitting	003-A1414	6	NP	Tip – Red	004-T6502-PT	2
4	Tee	003-TT14SQ	3	NP	Washer	004-1207W	3
5	Elbow	003-SE14F	3	NP	Not pictured		
6	Hose clamp	003-9002	12				
7	Hose	002-9016	9 ft				
8	Elbow	003-EL1414	6				
9	Hose clamp	003-9003	1				
10	Check valve	002-4564X	1				
11	Hose bracket	001-4720	1				
12	Female coupler	004-1207G	3				
13	Tip strainer	004-1203-200	3				
14	Shutoff cap	004-1207F	2				
15	Female disconnect	004-1207H	1				
16	Lynch pin	008-4576	2				
17	Saddle leg	001-4703B	2				

Harvest Tec Model 4508 Installation Kit

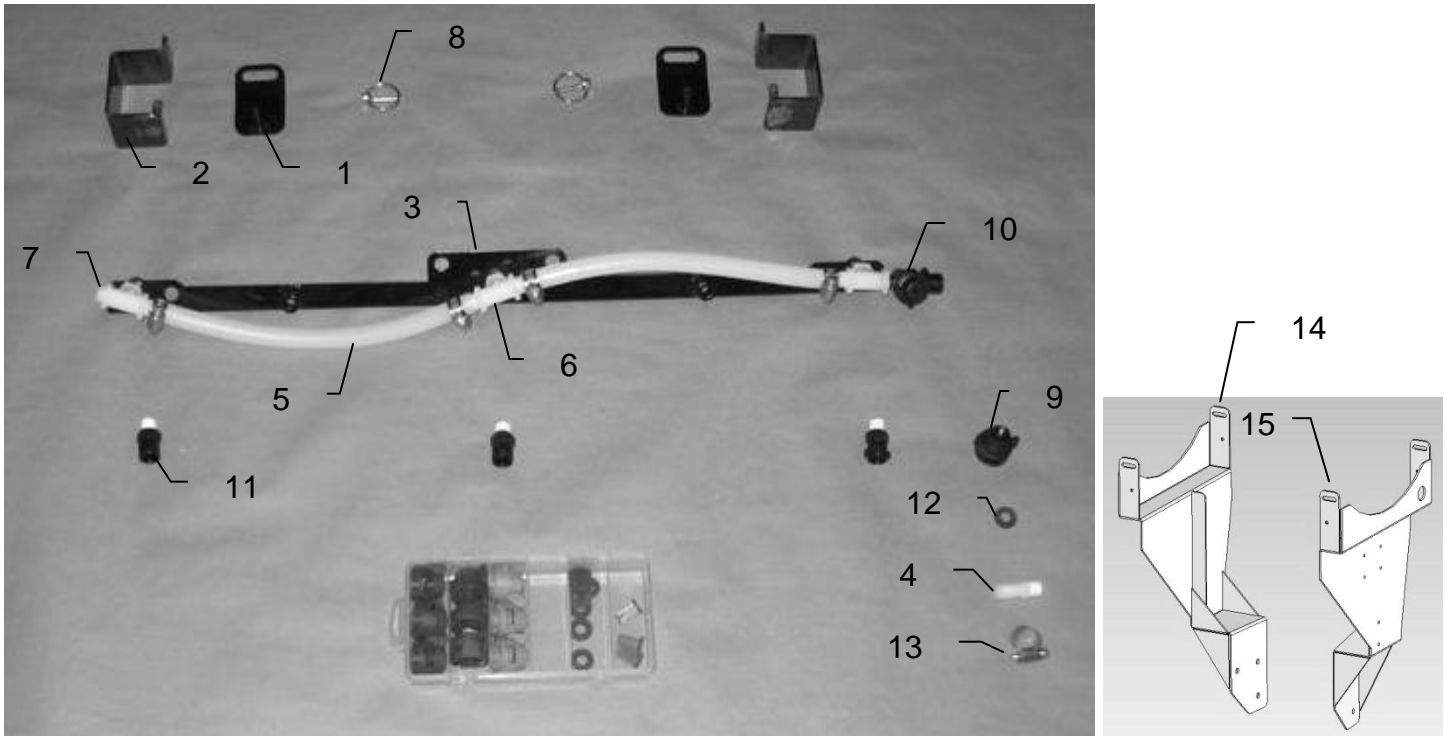

<u>Ref</u>	<u>Description</u>	<u>Part#</u>	<u>Qty</u>	<u>Description</u>	<u>Part#</u>	<u>Qty</u>
1	Shield holder	001-4703JB	2	Tip Kit (Complete)	030-9002	1
2	Shield holder	001-4703JC	2	Tip Kit Includes:		
3	Spray shield	001-4703GR	1	Plastic Box	008-9000	1
4	Straight fitting	003-A1412	5	Red Cap	004-1207B	3
5	Hose	002-9001	2	Outside Tip (Red Set)	004-650050-SS	2
6	Tee	003-TT14	3	Inside Tip (Red Set)	004-XR11001VS	1
7	Plug	003-F14	1	Green Cap	004-1207A	3
8	Lynch pin	008-4576	2	Outside Tip (Green Set)	004-6501-SS	2
9	Female disconnect	004-1207H	1	Inside Tip (Green Set)	004-XR110015VS	1
10	Check valve	004-1207V	1	Blue Cap	004-1207C	3
11	Nozzle body	004-4710	3	Outside Tip (Blue Set)	004-6502-SS	2
12	Washer	004-1207W	1	Inside Tip (Blue Set)	004-XR11002VS	1
13	Hose clamp	003-9003	5	Washer	004-1207W	9
14	Right leg	001-4703K	1	Tip Strainer	004-1203-100	3
15	Left leg	001-4703L	1			

Harvest Tec Model 4512 installation kit

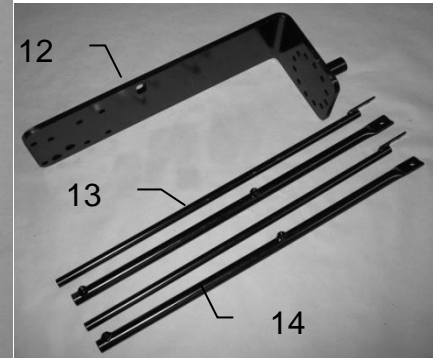
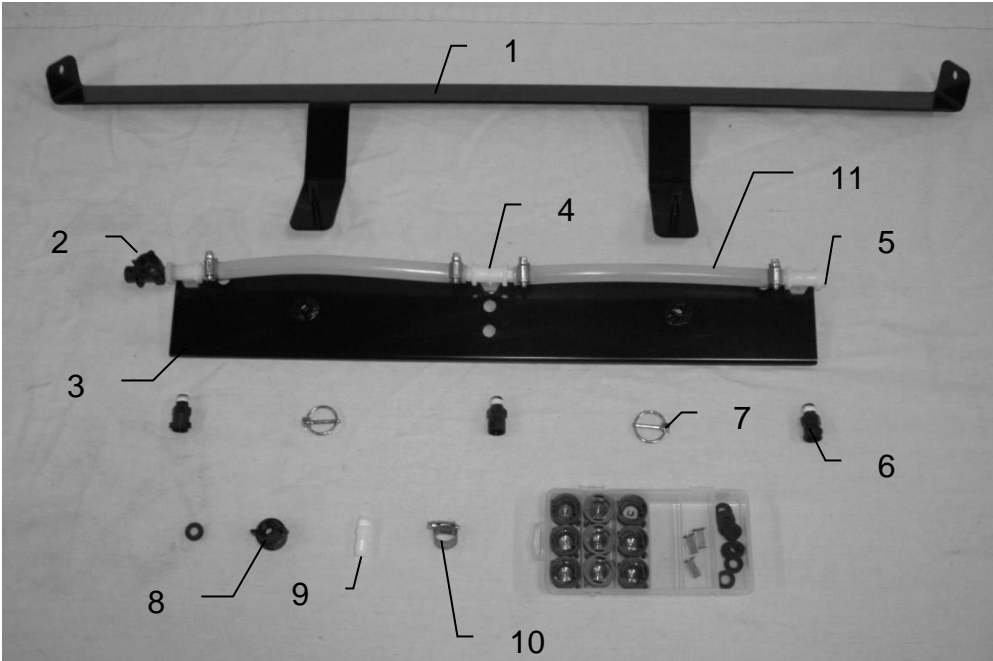

<u>Ref</u>	<u>Description</u>	<u>Part #</u>	<u>Qty</u>	<u>Description</u>	<u>Part #</u>	<u>Qty</u>
1	Shield holder	001-4704E	1	Tip Kit (Complete)	030-9002	1
2	Check valve	004-1207V	1	Plastic Box	008-9000	1
3	Spray shield	001-4703GR	1	Red Cap	004-1207B	3
4	Tee	003-TT14	3	Outside Tip (Red Set)	004-650050-SS	2
5	Plug	003-F14	1	Inside Tip (Red Set)	004-XR11001VS	1
6	Nozzle body	004-4710	3	Green Cap	004-1207A	3
7	Lynch pin	008-4576	2	Outside Tip (Green Set)	004-6501-SS	2
8	Female disconnect	004-1207H	1	Inside Tip (Green Set)	004-XR110015VS	1
9	Straight fitting	003-A1412	5	Blue Cap	004-1207C	3
10	Hose clamp	003-9003	5	Outside Tip (Blue Set)	004-6502-SS	2
11	Hose	002-9001	2	Inside Tip (Blue Set)	004-XR11002VS	1
12	Mounting bracket	001-4418	1	Tip strainer	004-1203-100	3
13	Inside support rod	001-4405	2	Washer	004-1207W	9
14	Outside support rod	001-4404	2			

Harvest Tec Model 4513 installation

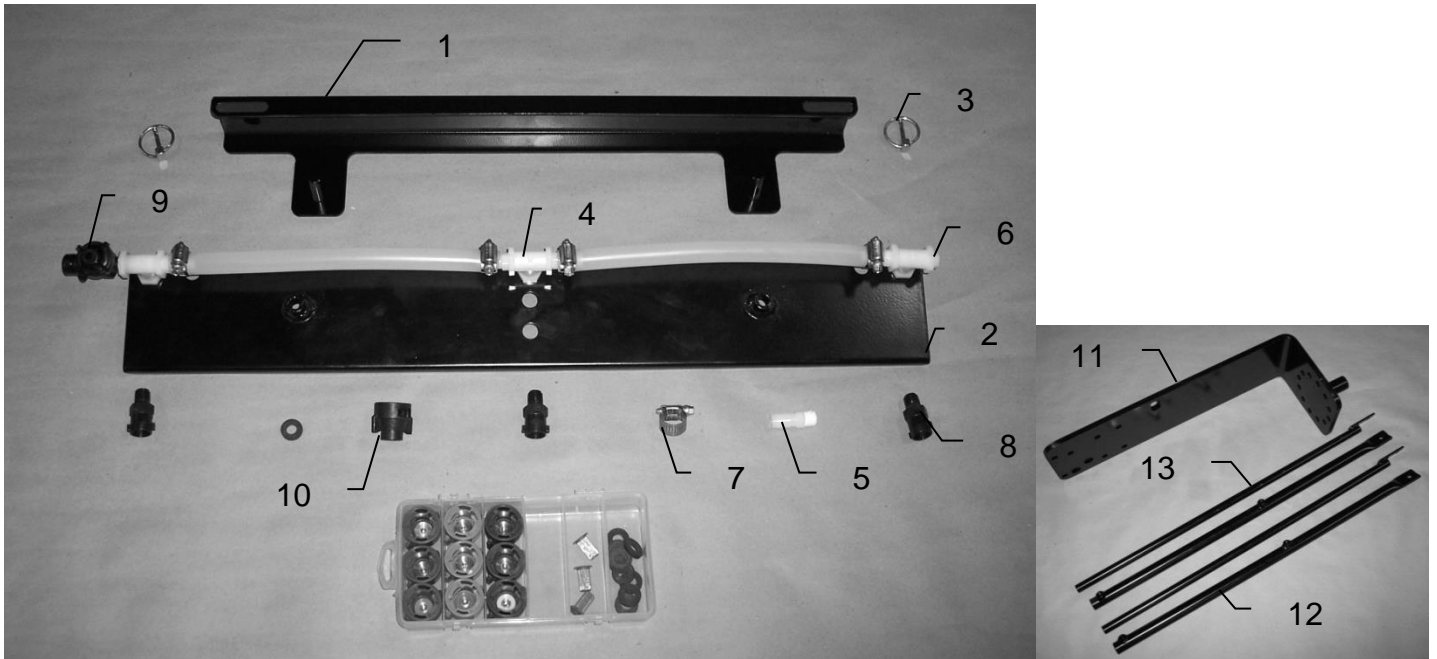

<u>Ref</u>	<u>Description</u>	<u>Part #</u>	<u>Qty</u>	<u>Description</u>	<u>Part #</u>	<u>Qty</u>
1	Shield bracket	001-4704D	1	Tip Kit (Complete)	030-9002	1
2	Spray shield	001-4703GR	1	Plastic Box	008-9000	1
3	Lynch pin	008-4576	2	Red Cap	004-1207B	3
4	Tee	003-TT14	3	Outside Tip (Red Set)	004-650050-SS	2
5	Straight fitting	003-A1412	5	Inside Tip (Red Set)	004-XR11001VS	1
6	Plug	003-F14	1	Green Cap	004-1207A	3
7	Hose clamp	003-9003	5	Outside Tip (Green Set)	004-6501-SS	2
8	Male quick fitting	004-4710	3	Inside Tip (Green Set)	004-XR110015VS	1
9	Check valve	004-1207V	1	Blue Cap	004-1207C	3
10	Female disconnect	004-1207H	1	Outside Tip (Blue Set)	004-6502-SS	2
11	Mounting bracket	001-4418	1	Inside Tip (Blue Set)	004-XR11002VS	1
12	Outside support rod	001-4404	2	Tip strainer	004-1203-100	3
13	Inside support rod	001-4405	2	Washer	004-1207W	9

Model 4516 Installation Kit John Deere 8 & 9 Series Balers

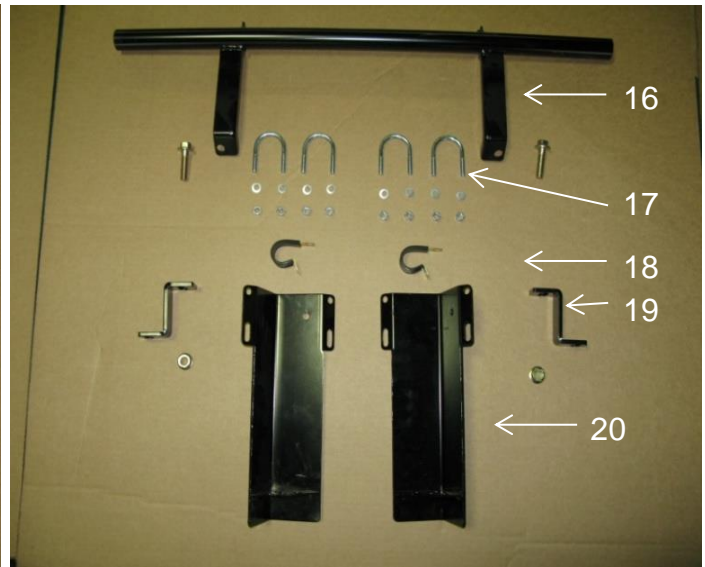
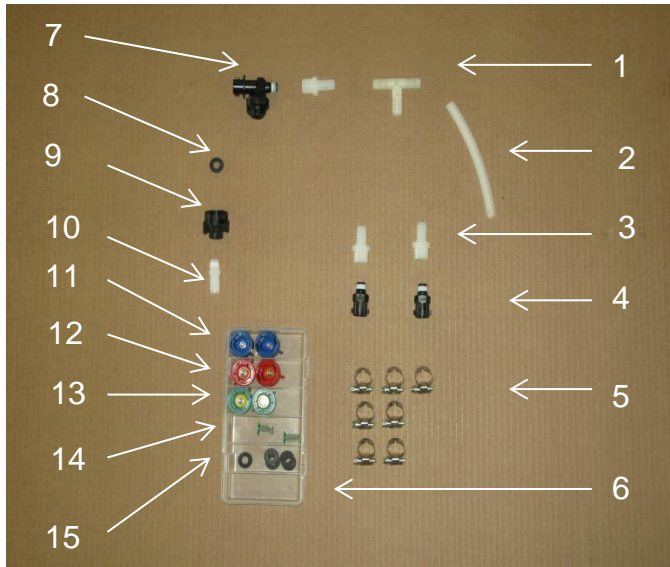

<u>Ref</u>	<u>Description</u>	<u>Part #</u>	<u>Qty</u>	<u>Ref</u>	<u>Description</u>	<u>Part #</u>	<u>Qty</u>
1	Tee	003-T1212	1	14	Strainer	004-1203-100	2
2	Hose	002-9001	4 ft	15	Rubber Washer	004-1207W	6
3	Fitting	003-A1412F	3	16	Nozzle Holder	001-4703R	1
4	Fitting	004-4710	2	17	5/16" U-bolt	001-4714UBS	4
5	Hose Clamps	003-9003	7	18	Jiffy Clips	008-9009	2
6	PLANO BOX	008-9000	1	19	Spacer	001-4703NS	2
7	Check Valve	004-1207V	1	20	Nozzle Mount	001-4714J	2
8	Rubber Washer	004-1207W	6	21	Mounting Bracket	001-4411	1
9	Coupler	004-1207H	1	22	Support	001-4411A	1
10	Fitting	003-A1412	1				
11	Cap-blue	004-1207C	2	11a	TIP-Blue	004-XR11003VS	2
12	Cap-red	004-1207B	2	12a	TIP-Orange	004-XR11001VS	2
13	Cap-green	004-1207A	2	13a	TIP-Yellow	004-XR11002VS	2

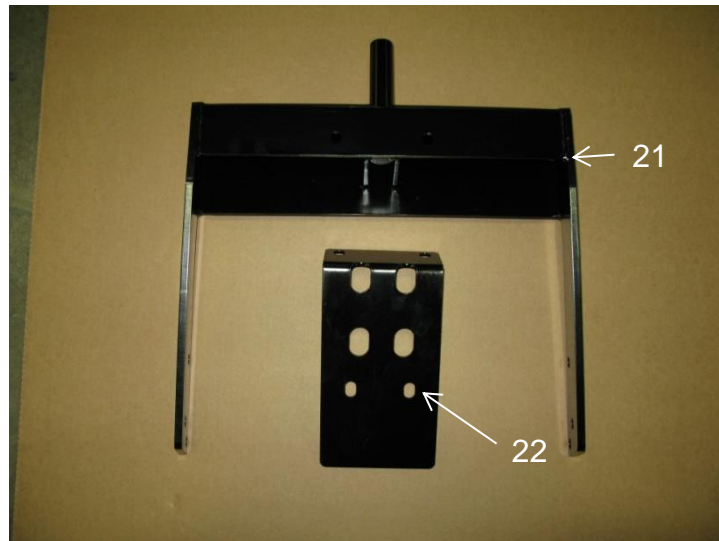

Model 4517 Installation Kit John Deere 8 & 9 Series Balers

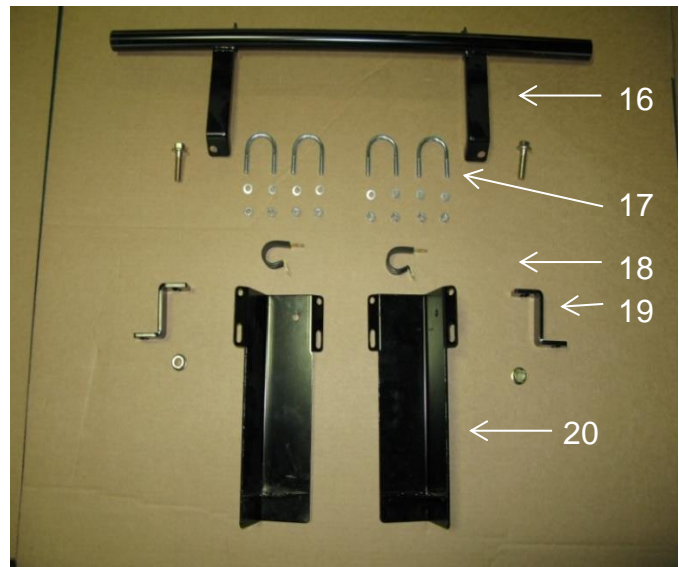
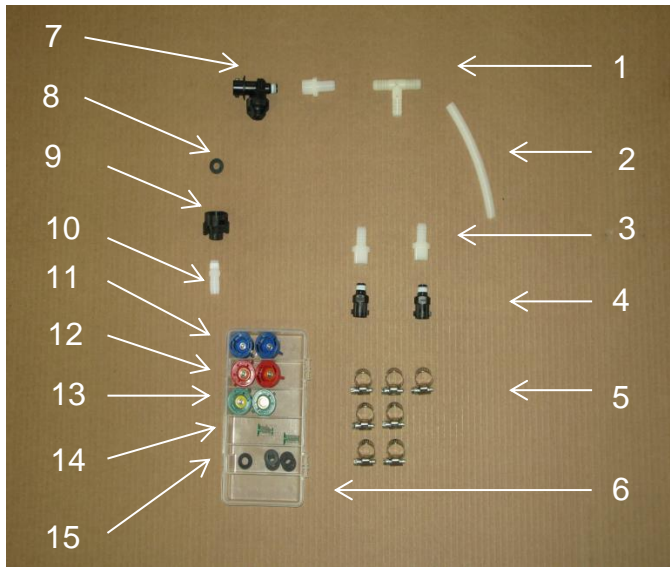

<u>Ref</u>	<u>Description</u>	<u>Part #</u>	<u>Qty</u>	<u>Ref</u>	<u>Description</u>	<u>Part #</u>	<u>Qty</u>
1	Tee	003-T1212	1	14	Strainer	004-1203-100	2
2	Hose	002-9001	4 ft	15	Rubber Washer	004-1207W	6
3	Fitting	003-A1412F	3	16	Nozzle Holder	001-4703R	1
4	Fitting	004-4710	2	17	5/16" U-bolt	001-4714UBS	4
5	Hose Clamps	003-9003	7	18	Jiffy Clips	008-9009	2
6	PLANO BOX	008-9000	1	19	Spacer	001-4703NS	2
7	Check Valve	004-1207V	1	20	Nozzle Mount	001-4714J	2
8	Rubber Washer	004-1207W	6	21	Saddle Leg	001-4703B	2
9	Coupler	004-1207H	1	22	Right Bracket	001-4703DR	1
10	Fitting	003-A1412	1	23	Left Bracket	001-4703DL	1
11	Cap-blue	004-1207C	2	11a	TIP-Blue	004-XR11003VS	2
12	Cap-red	004-1207B	2	12a	TIP-Orange	004-XR11001VS	2
13	Cap-green	004-1207A	2	13a	TIP-Yellow	004-XR11002VS	2

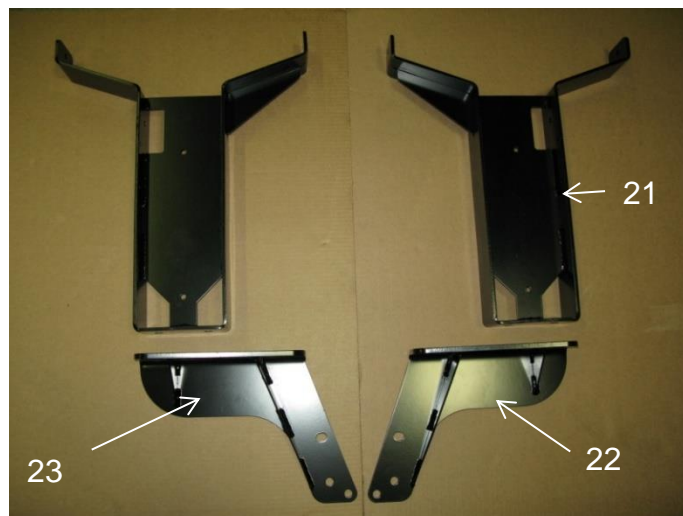

445Z Spray Shield (4516-SO)

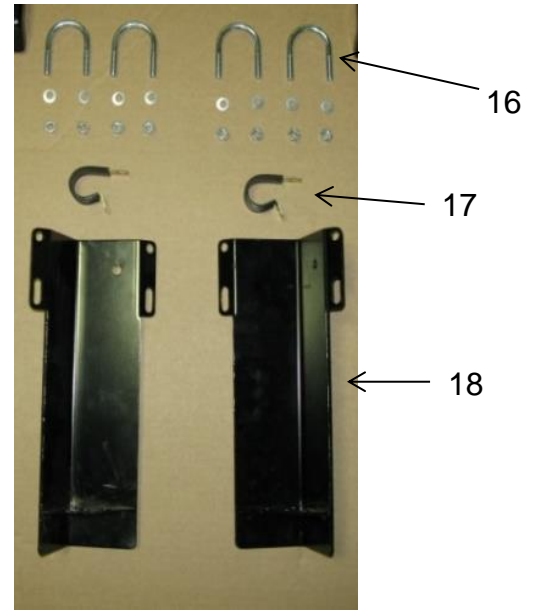
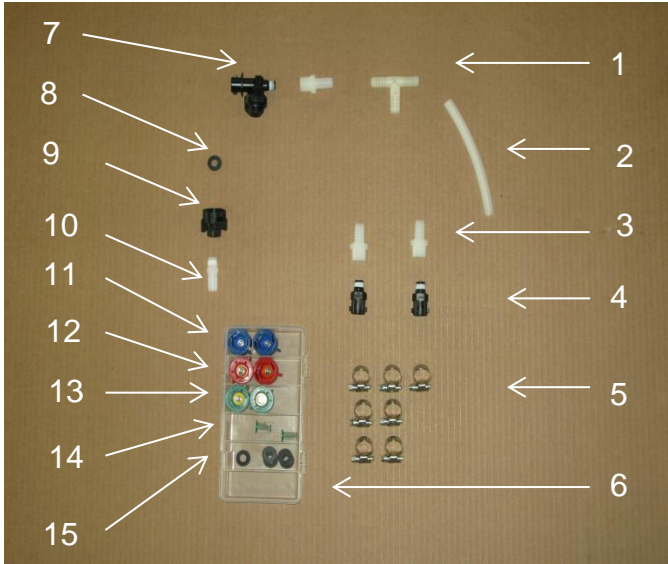

<u>Ref</u>	<u>Description</u>	<u>Part #</u>	<u>Qty</u>	<u>Ref</u>	<u>Description</u>	<u>Part #</u>	<u>Qty</u>
1	Tee	003-T1212	1	14	Strainer	004-1203-100	2
2	Hose	002-9001	4 ft	15	Rubber Washer	004-1207W	6
3	Fitting	003-A1412F	3	16	5/16" U-bolt	001-4714UBS	4
4	Fitting	004-4710	2	17	Jiffy Clips	008-9009	2
5	Hose Clamps	003-9003	7	18	Nozzle Mount	001-4714J	2
6	PLANO BOX	008-9000	1				
7	Check Valve	004-1207V	1	11a	TIP-Blue	004-XR11003VS	2
8	Rubber Washer	004-1207W	6	12a	TIP-Orange	004-XR11001VS	2
9	Coupler	004-1207H	1	13a	TIP-Yellow	004-XR11002VS	2
10	Fitting	003-A1412	1				
11	Cap-blue	004-1207C	2				
12	Cap-red	004-1207B	2				
13	Cap-green	004-1207A	2				

Harvest Tec Model 4523 installation kit

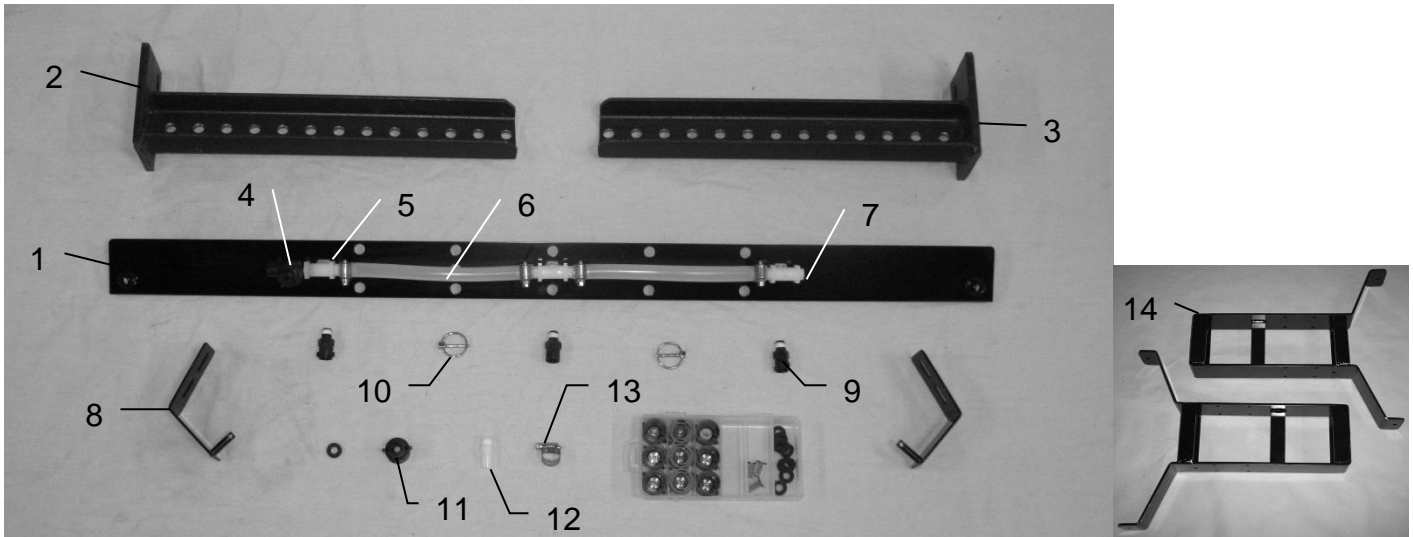

<u>Ref</u>	<u>Description</u>	<u>Part #</u>	<u>Qty</u>	<u>Description</u>	<u>Part #</u>	<u>Qty</u>
1	Spray shield	001-4704G	1	Tip Kit (Complete)	030-9002	1
2	Support leg right	001-4704JR	1	Tip Kit Includes:		
3	Support leg left	001-4704JL	1	Plastic Box	008-9000	1
4	Check valve	004-1207V	1	Red Cap	004-1207B	3
5	Tee	003-TT14	3	Outside Tip (Red Set)	004-650050-SS	2
6	Hose	002-9001	2	Inside Tip (Red Set)	004-XR11001VS	1
7	Plug	003-F14	1	Green Cap	004-1207A	3
8	Shield hanger	001-4704H	2	Outside Tip (Green Set)	004-6501-SS	2
9	Nozzle body	004-4710	3	Inside Tip (Green Set)	004-XR110015VS	1
10	Lynch pin	008-4576	2	Blue Cap	004-1207C	3
11	Coupler	004-1207H	1	Outside Tip (Blue Set)	004-6502-SS	2
12	Straight fitting	003-A1412	5	Inside Tip (Blue Set)	004-XR11002VS	1
13	Hose clamp	003-9003	5	Washer	004-1207W	9
14	Saddle legs	004-4703B	2	Tip Strainer	004-1203-100	3

Harvest Tec Model 4524 Installation Kit

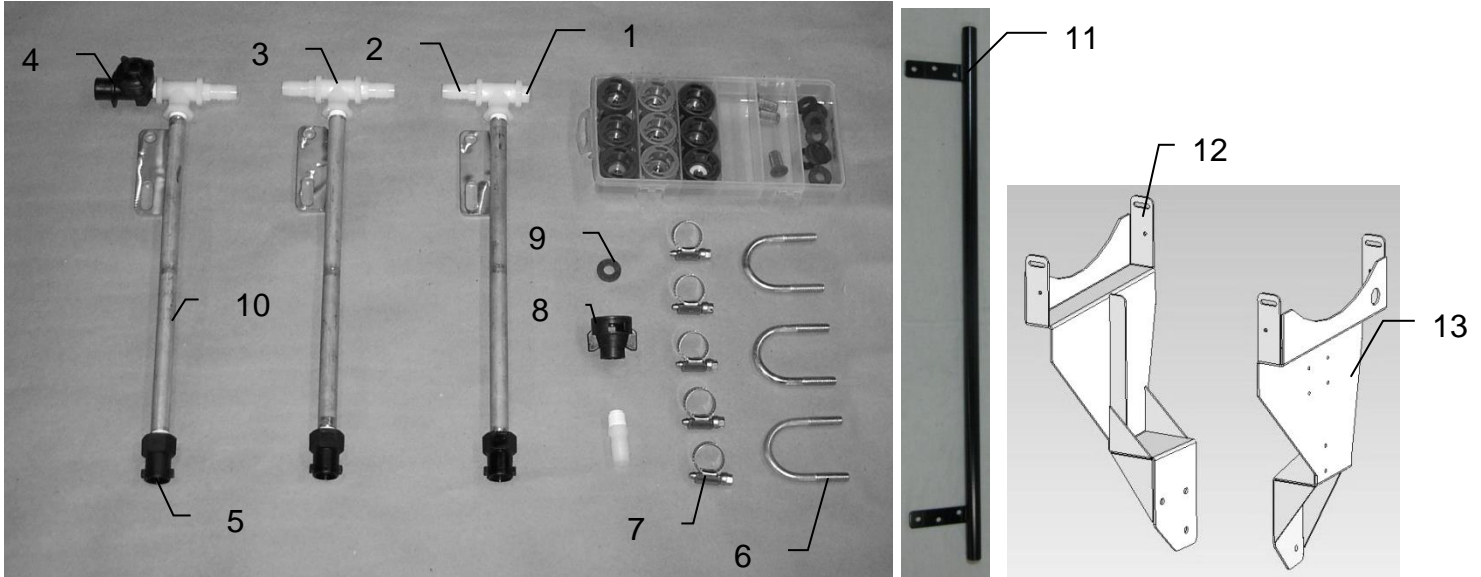

<u>Ref</u>	<u>Description</u>	<u>Part#</u>	<u>Qty</u>	<u>Description</u>	<u>Part#</u>	<u>Qty</u>
1	Plug	003-F14	1	Tip Kit (Complete)	030-9002	1
2	Straight fitting	003-A1412	5	Tip Kit Includes:		
3	Tee	003-TT14	3	Plastic Box	008-9000	1
4	Check valve	004-1207V	1	Red Cap	004-1207B	3
5	Female coupler	004-1207G	3	Outside Tip (Red Set)	004-650050-SS	2
6	U bolt	001-4714UBS	3	Inside Tip (Red Set)	004-XR11001VS	1
7	Hose clamp	003-9002	5	Green Cap	004-1207A	3
8	Female disconnect	004-1207H	1	Outside Tip (Green Set)	004-6501-SS	2
9	Washer	004-1207W	1	Inside Tip (Green Set)	004-XR110015VS	1
10	Nozzle tube	001-4714	3	Blue Cap	004-1207C	3
11	Nozzle holder	001-4703T	1	Outside Tip (Blue Set)	004-6502-SS	2
12	Right leg	001-4703K	1	Inside Tip (Blue Set)	004-XR11002VS	1
13	Left leg	001-4703L	1	Washer	004-1207W	9
				Tip Strainer	004-1203-100	3

Harvest Tec Model 4526 Installation Kit

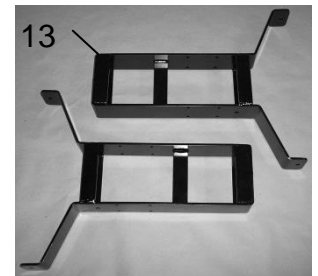
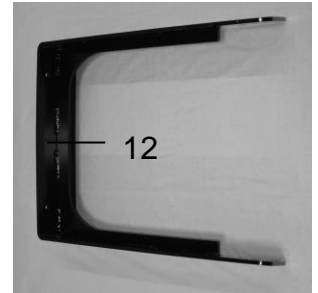
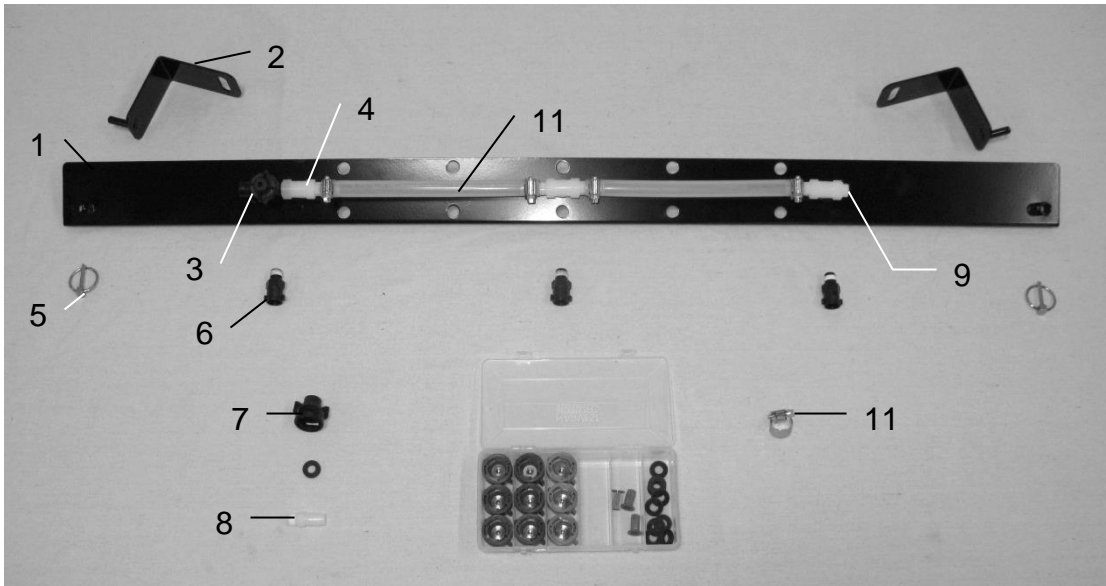

<u>Ref</u>	<u>Description</u>	<u>Part #</u>	<u>Qty</u>	<u>Description</u>	<u>Part #</u>	<u>Qty</u>
1	Spray shield	001-4704G	1	Tip Kit (Complete)	030-9002	1
2	Shield hanger	001-4704MC	2	Tip Kit Includes:		
3	Check valve	004-1207V	1	Plastic Box	008-9000	1
4	Tee	003-TT14	3	Red Cap	004-1207B	3
5	Lynch pin	008-4576	2	Outside Tip (Red Set)	004-650050-SS	2
6	Nozzle body	004-4710	3	Inside Tip (Red Set)	004-XR11001VS	1
7	Coupler	004-1207H	1	Green Cap	004-1207A	3
8	Straight fitting	003-A1412	5	Outside Tip (Green Set)	004-6501-SS	2
9	Plug	003-F14	1	Inside Tip (Green Set)	004-XR110015VS	1
10	Hose clamp	003-9003	5	Blue Cap	004-1207C	3
11	Hose	002-9001	2	Outside Tip (Blue Set)	004-6502-SS	2
12	Mounting bracket	001-4704MA	1	Inside Tip (Blue Set)	004-XR11002VS	1
13	Saddle legs	001-4703B	2	Washer	004-1207W	9
				Tip Strainer	004-1203-100	3

Model 4538 Installation Kit

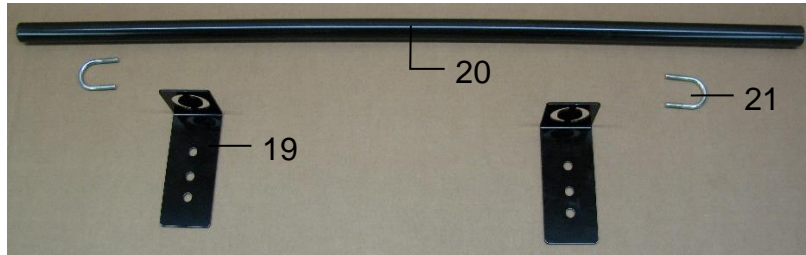
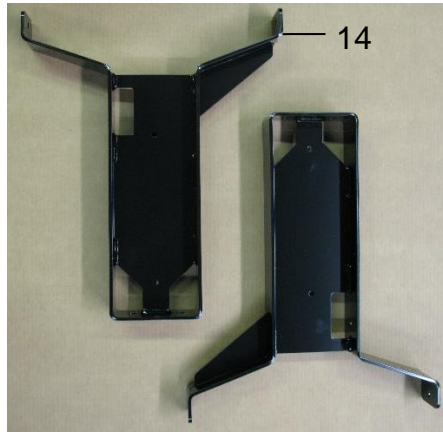
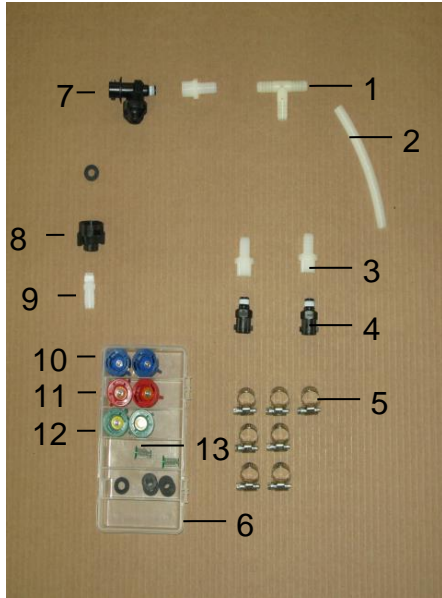

<u>Ref</u>	<u>Description</u>	<u>Part #</u>	<u>Qty</u>	<u>Ref</u>	<u>Description</u>	<u>Part #</u>	<u>Qty</u>
1	Tee	003-T1212	1	14	Tank Leg – Long	001-4703B	2
2	Hose	002-9001	2 ft	15	Nozzle Holder	001-4714JS	2
3	Fitting	003-A1412F	3	16	Side Support	001-4704MA	2
4	Fitting	004-4710	2	17	Brace Support	001-4704MDJ	2
5	Hose Clamps	003-9003	5	18	Top Support	001-4704MEJ	1
6	Plano Box	008-9000	1	19	Nozzle Mount	001-4703TP	2
7	Check Valve	004-1207V	1	20	Tube Holder	001-4703TH	1
8	Coupler	004-1207H	1	21	U-bolt	001-4714UBS	6
9	Fitting	003-A1412	1				
10	Cap-blue	004-1207C	2	NP	Oetiker Clamp	003-9005	4
11	Cap-red	004-1207B	2	NP	TIP-Blue	004-XR11003VS	2
12	Cap-green	004-1207A	2	NP	TIP-Orange	004-XR11001VS	2
13	Strainer	004-1203-100	2	NP	TIP-Yellow	004-XR11002VS	2

Model 4546 Installation Kit John Deere 0 Series Round Balers

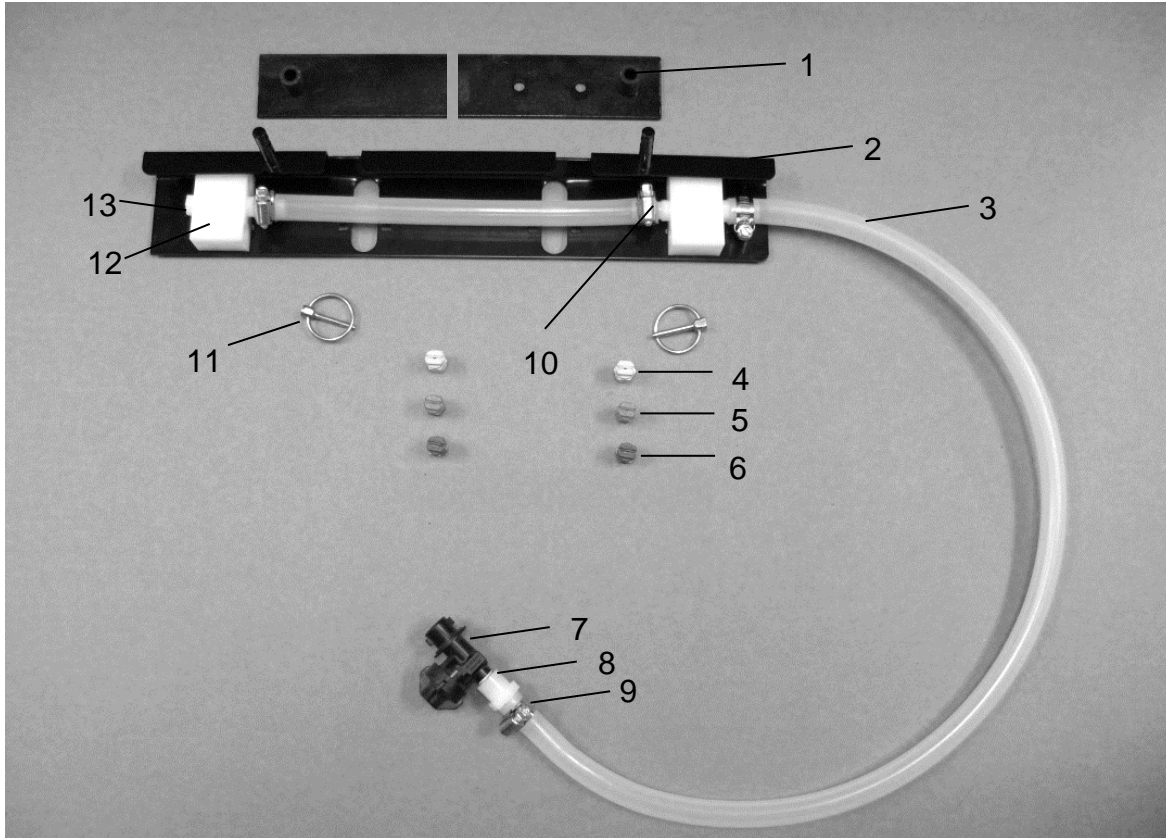

<u>Ref</u>	<u>Description</u>	<u>Part #</u>	<u>Qty</u>	<u>Ref</u>	<u>Description</u>	<u>Part #</u>	<u>Qty</u>
1	Holder	001-4435NCX2	2	11	Lynch Pin	008-4576	2
2	Shield	001-4435NSX	1	12	Manifold Block	001-4435NSB	2
3	Hose-1/2"	002-9001	4 ft	13	Fitting	003-F14	1
4	Tip-Pink / Grey	004-T8001-PT	2	14	Mounting Bracket	001-4411	1
5	Tip-Orange / Grey	004-T8002-PT	2	15	Support	001-4411A	1
6	Tip-Red / Grey	004-T8003-PT	2	NP	Strainer	004-1203-100	1
7	Check Valve	004-1207V	1	NP	Clamping UBolt 2"	001-4714UBX	1
8	Fitting	003-A1412F	1	NP	Female 1/4" Disc.	004-1207H	1
9	Hose Clamp	003-9003	4	NP	Mini Plano Box	008-9001	1
10	Fitting	003-A1412	4				

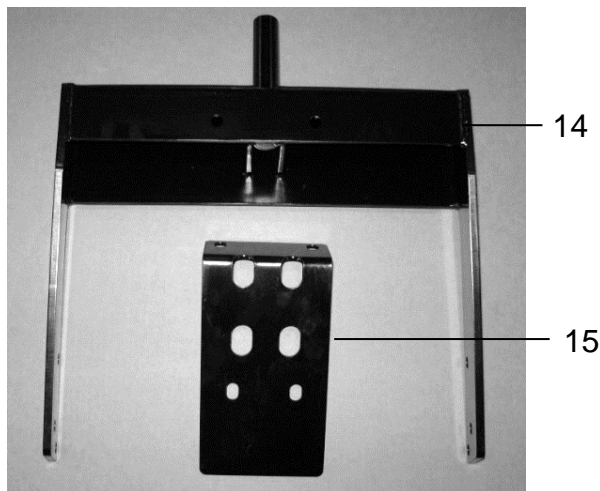

Model 4547 Installation Kit John Deere 0 Series Round Balers

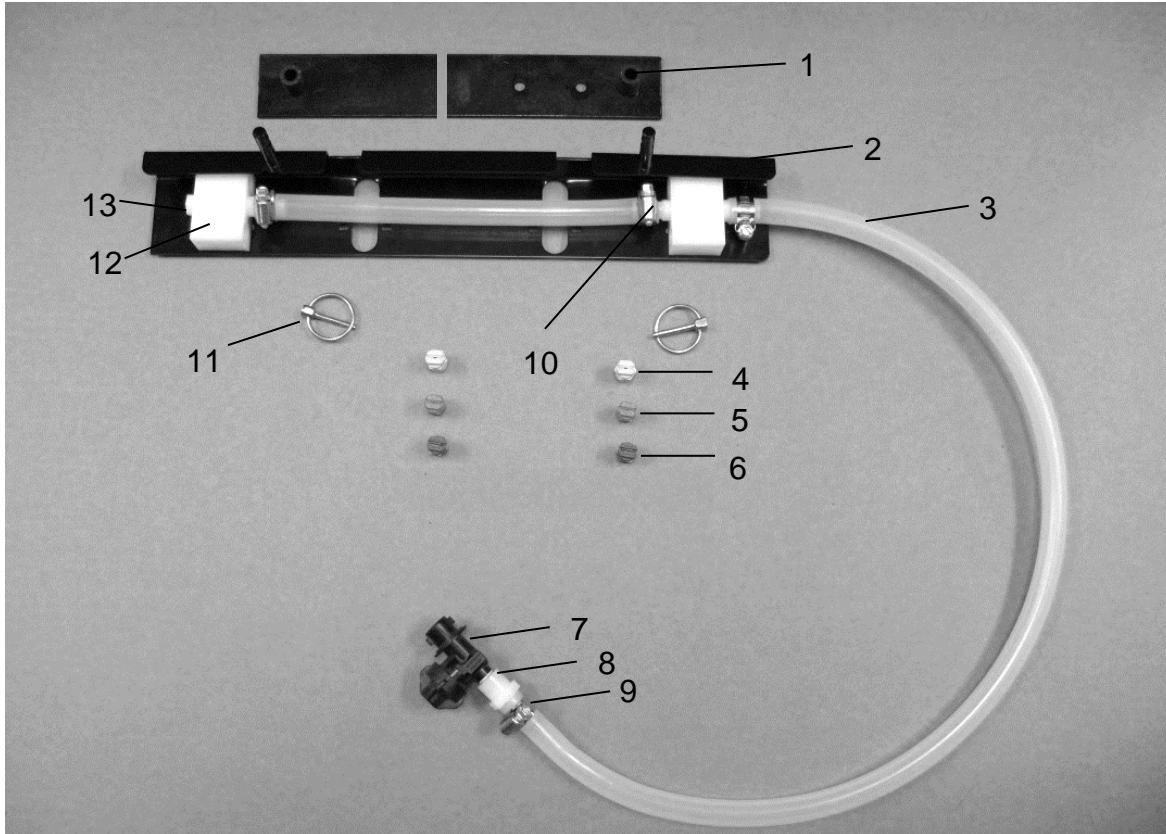

<u>Ref</u>	<u>Description</u>	<u>Part #</u>	<u>Qty</u>	<u>Ref</u>	<u>Description</u>	<u>Part #</u>	<u>Qty</u>
1	Holder	001-4435NCX2	2	12	Manifold Block	001-4435NSB	2
2	Shield	001-4435NSX	1	13	Fitting	003-F14	1
3	Hose-1/2"	002-9001	4 ft	14	Mounting Bracket	001-4411	1
4	Tip-Pink / Grey	004-T8001-PT	2	15	Support	001-4411A	1
5	Tip-Orange / Grey	004-T8002-PT	2	16	Saddle Leg	001-4703B	2
6	Tip-Red / Grey	004-T8003-PT	2	17	Right Bracket	001-4703DR	1
7	Check Valve	004-1207V	1	18	Left Bracket	001-4703DL	1
8	Fitting	003-A1412F	1	NP	Strainer	004-1203-100	1
9	Hose Clamp	003-9003	4	NP	Clamping UBolt 2"	001-4714UBX	1
10	Fitting	003-A1412	4	NP	Female 1/4" Disc.	004-1207H	1
11	Lynch Pin	008-4576	2	NP	Mini Plano Box	008-9001	1

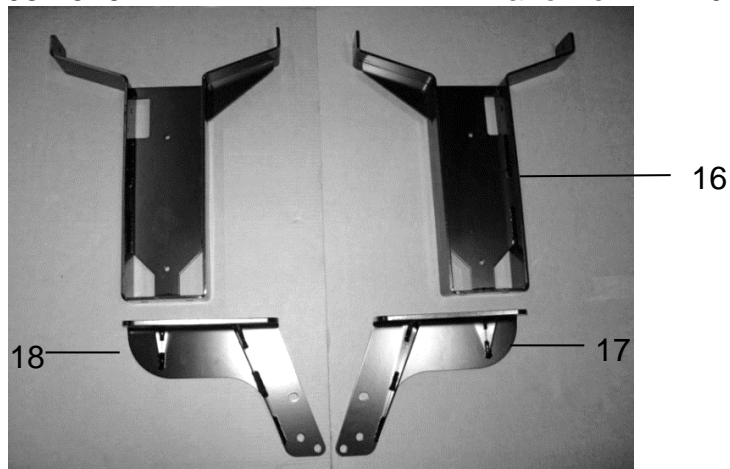

Notes

Notes

Notes

Harvest Tec LLC. Warranty and Liability Agreement

Harvest Tec, LLC. . will repair or replace components that are found to be defective within 12 months from the date of manufacture. Under no circumstances does this warranty cover any components which in the opinion of Harvest Tec, LLC. . have been subjected to negligent use, misuse, alteration, accident, or if repairs have been made with parts other than those manufactured and obtainable from Harvest Tec, LLC. .

Our obligation under this warranty is limited to repairing or replacing free of charge to the original purchaser any part that in our judgment shows evidence of defective or improper workmanship, provided the part is returned to Harvest Tec, LLC. . within 30 days of the failure. If it is determined that a non-Harvest Tec branded hay preservative has been used inside the Harvest Tec applicator system where the failure occurred, then Harvest Tec reserves the right to deny the warranty request at their discretion. Parts must be returned through the selling dealer and distributor, transportation charges prepaid.

This warranty shall not be interpreted to render Harvest Tec, LLC. . liable for injury or damages of any kind, direct, consequential, or contingent, to persons or property. Furthermore, this warranty does not extend to loss of crop, losses caused by delays or any expense prospective profits or for any other reason. Harvest Tec, LLC. . shall not be liable for any recovery greater in amount than the cost or repair of defects in workmanship.

There are no warranties, either expressed or implied, of merchantability or fitness for particular purpose intended or fitness for any other reason.

This warranty cannot guarantee that existing conditions beyond the control of Harvest Tec, LLC. . will not affect our ability to obtain materials or manufacture necessary replacement parts.

Harvest Tec, LLC. . reserves the right to make design changes, improve design, or change specifications, at any time without any contingent obligation to purchasers of machines and parts previously sold.

Revised 5/22

HARVEST TEC, LLC. .
P.O. BOX 63
2821 HARVEY STREET
HUDSON, WI 54016 USA
PHONE: 715-386-9100
1-800-635-7468
FAX: 715-381-1792
Email: info@harvesttec.com